



Features and Benefits

- Low phase noise
- Linear tuning characteristics
- Low pushing / Low pulling
- Aqueous washable

Typical Applications

- SATCOM
- Receiver
- Test Equipment
- Radar
- Point –to-Point Radio
- MMDS
- WiMax

Specifications

| Parameter | Units | Min. | Typical | Max. |
|---------------------------------|---------|------|---------|------|
| Operating Frequency Range | MHz | 1664 | | 1664 |
| Output Power | dBm | | 7 | |
| Phase Noise @10kHz offset | dBc/Hz | | -125 | |
| Tuning Voltage (Vt) | Vdc | | 0.5-4.5 | |
| Tuning Voltage Sensitivity (Kv) | MHz/V | | 6 | |
| 2nd Harmonic Suppression | dBc | | -20 | |
| Power Supply (Vcc) | Voltage | | 8 | |
| | Current | | 24 | |
| Operating Temp. Range | °C | -40 | | +85 |

Mechanical Drawing & Pin Connections

Drawing No: MD140084-1

Top View



Bottom View



Foot Print

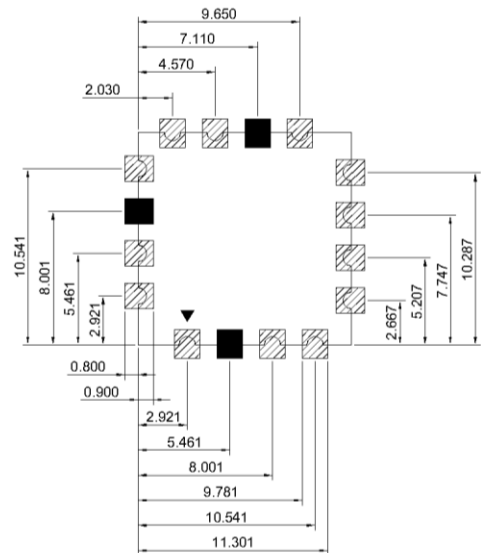

Side View



Pin Connections

| | |
|--------|-------|
| 2 | Vt |
| 10 | RFOUT |
| 14 | Vcc |
| Others | GND |

Unit : mm