



Features and Benefits

- Low phase noise
- Linear tuning characteristics
- Low pushing / Low pulling
- Aqueous washable

Typical Applications

- SATCOM Point-to-Point
- Receiver Radio
- Test Equipment MMDS
- Radar WiMax

Specifications

Parameter	Units	Min.	Typical	Max.
Operating Frequency Range	MHz	3400		3400
Output Power	dBm		0	
Phase Noise @10kHz offset	dBc/Hz		-100	
Tuning Voltage (Vt)	Vdc		0.5-4.5	
Tuning Voltage Sensitivity (Kv)	MHz/V		35	
2nd Harmonic Suppression	dBc		-15	
Power Supply (Vcc) Voltage	Vdc		5	
Power Supply (Vcc) Current	mA		27	
Operating Temp. Range	°C	-40		+85

Mechanical Drawing & Pin Connections

Drawing No: MD140084-1

Top View

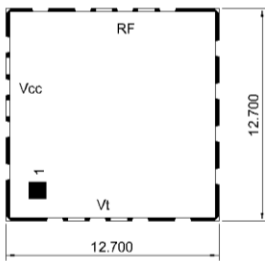

Bottom View

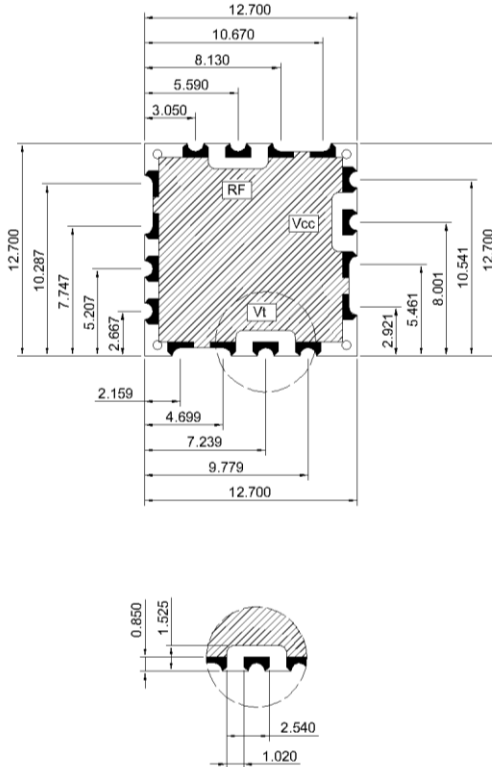

Foot Print

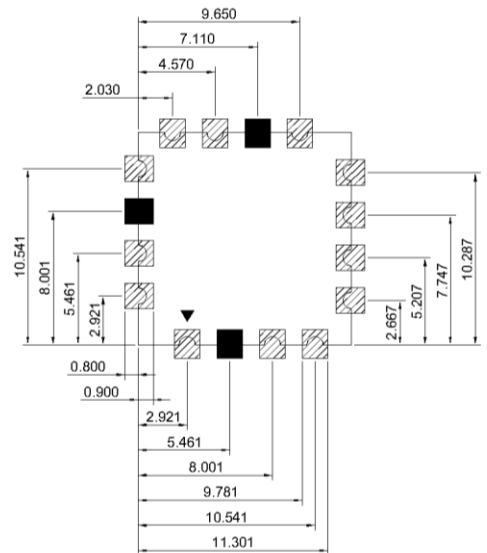

Side View



Pin Connections

2	Vt
10	RFOUT
14	Vcc
Others	GND

Unit : mm