

DESCRIPTION:

PLANAR MONOLITHICS INDUSTRIES MODEL NUMBER DTA-812-BA-80-14B-SFF OPT10D27 IS A DIGITALLY TUNED ATTENUATOR COVERING THE 8 TO 12 GHz FREQUENCY RANGE AND OPTIMIZED FOR 10.27 GHz. THIS UNIT IS TUNED USING FOURTEEN +3.3V RS-422 CONTROL BITS.

SPECIFICATIONS:

- FREQUENCY:..... 8 TO 12 GHz, OPTIMIZED FOR 10.27 GHz
- VSWR (J1 AND J2):..... 2:1 MAX (8-12 GHz), 1.5:1 MAX (10.27 ± 0.5 GHz)
- INPUT P1dB POWER LEVEL:..... +20 dBm MIN
- SURVIVAL INPUT POWER LEVEL:..... +30 dBm MAX
- INSERTION LOSS:..... 5 dB GOAL, 8 dB MAX

- SPURIOUS SIGNALS:..... -100 dBc GOAL
- AMPLITUDE NOISE @ ≥ 1 MHz OFFSET:..... -160 dBc/Hz GOAL
- PHASE NOISE @ ≥ 1 MHz OFFSET:..... -160 dBc/Hz GOAL

- SWITCHING SPEED:..... 400 ns GOAL, 500 ns MAX

- ATTENUATION RANGE:..... 80 dB NOMINAL (0 TO (80 dB - 1 LSB))
- ATTENUATION ACCURACY (@ +25°C):..... ± 1.5 dB MAX (10.27 ± 0.5 GHz)

- DIGITAL CONTROL BITS:..... 14 BITS
- CONTROL LOGIC:..... +3.3V RS-422 (+5V TOLERANT), ALL BITS - > + FOR INSERTION LOSS SETTING

- LATCH CONTROL LOGIC:..... +3.3V RS-422 (+5V TOLERANT), LATCH + > LATCH - TO ENABLE ON RISING EDGE

LATCH TIMING DIAGRAM:

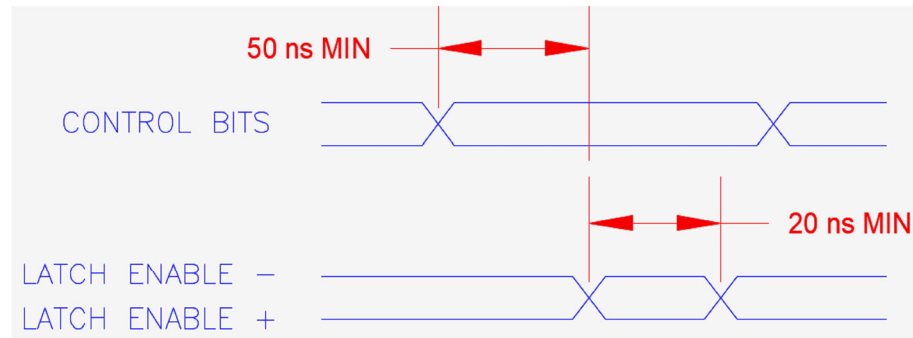

- POWER SUPPLY:..... +12 V @ 250 mA MAX
-12 V @ 100 mA MAX

- RF CONNECTORS:..... SMA (F)
- POWER / CONTROL CONNECTOR:..... 44 PIN HIGH DENSITY D-SUB (M)

- FINISH:..... PAINTED BLUE, MOUNTING SURFACE GOLD PLATED

ENVIRONMENTAL RATINGS:

- TEMPERATURE:..... +10°C TO +30°C (OPERATING)
-40°C TO +85°C (STORAGE)

ZONE	REV.	DESCRIPTION	DATE	APPROVED
	A1	ORIGINAL RELEASE	11/16/2021	
	A2	ECN # 22-0078	6/13/2022	

J3 44-PIN CONNECTOR PIN-OUT					
PIN	FUNCTION	VALUE	PIN	FUNCTION	VALUE
1	CONTROL BIT 0 +	(0.0048828125 dB) - LSB	23	CONTROL BIT 0 -	(0.0048828125 dB) - LSB
2	CONTROL BIT 1 +	(0.009765625 dB)	24	CONTROL BIT 1 -	(0.009765625 dB)
3	CONTROL BIT 2 +	(0.01953125 dB)	25	CONTROL BIT 2 -	(0.01953125 dB)
4	CONTROL BIT 3 +	(0.0390625 dB)	26	CONTROL BIT 3 -	(0.0390625 dB)
5	CONTROL BIT 4 +	(0.078125 dB)	27	CONTROL BIT 4 -	(0.078125 dB)
6	CONTROL BIT 5 +	(0.15625 dB)	28	CONTROL BIT 5 -	(0.15625 dB)
7	CONTROL BIT 6 +	(0.3125 dB)	29	CONTROL BIT 6 -	(0.3125 dB)
8	CONTROL BIT 7 +	(0.625 dB)	30	CONTROL BIT 7 -	(0.625 dB)
9	CONTROL BIT 8 +	(1.25 dB)	31	CONTROL BIT 8 -	(1.25 dB)
10	CONTROL BIT 9 +	(2.5 dB)	32	CONTROL BIT 9 -	(2.5 dB)
11	CONTROL BIT 10 +	(5 dB)	33	CONTROL BIT 10 -	(5 dB)
12	CONTROL BIT 11 +	(10 dB)	34	CONTROL BIT 11 -	(10 dB)
13	CONTROL BIT 12 +	(20 dB)	35	CONTROL BIT 12 -	(20 dB)
14	CONTROL BIT 13 +	(40 dB) - MSB	36	CONTROL BIT 13 -	(40 dB) - MSB
15	LATCH ENABLE +		37	LATCH ENABLE -	
16	GND		38	GND	
17	GND		39	GND	
18	+V		40	-V	
19	+V		41	-V	
20	+V		42	-V	
21	GND		43	GND	
22	GND		44	GND	

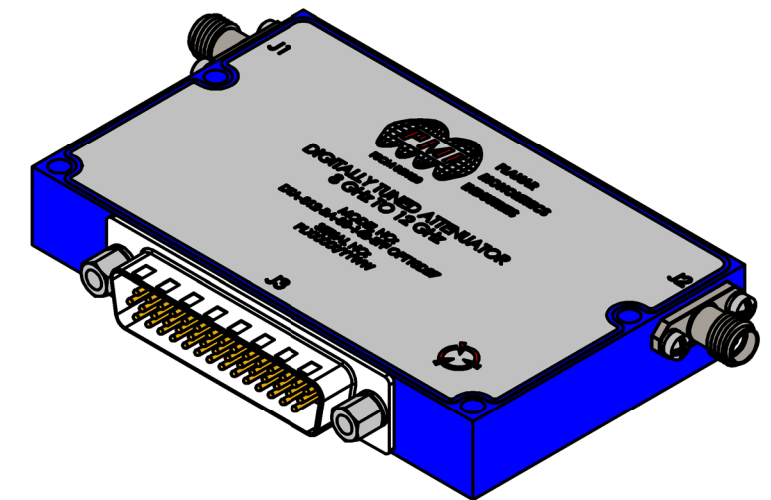

PMI CONFIDENTIAL AND PROPRIETARY

APPROVALS DRAWN R. SIRK REDRAWN ISSUED		DATE 11/16/2021		TITLE OUTLINE DTA-812-BA-80-14B-SFF OPT10D27			
				SIZE B	FSCM NO. 05XQ0	DWG NO. 27041500	REV. A2
UNLESS OTHERWISE SPECIFIED DIMENSIONS ARE IN INCHES TOLERANCES ARE: FRACTIONS DECIMALS ANGLES ± .XX ± 0.02 ± .XXX ± 0.01				SCALE 1:1		SHEET 1 OF 2	

PLANAR MONOLITHICS INDUSTRIES, INC.

7311-F GROVE ROAD
 FREDERICK, MARYLAND 21704 USA
 TEL: (301)-862-5019; FAX: (301)-862-1731
 WEB: www.pmi-rf.com; EMAIL: sales@pmi-rf.com
 ISO 9001 CERTIFIED

MECHANICAL OUTLINE

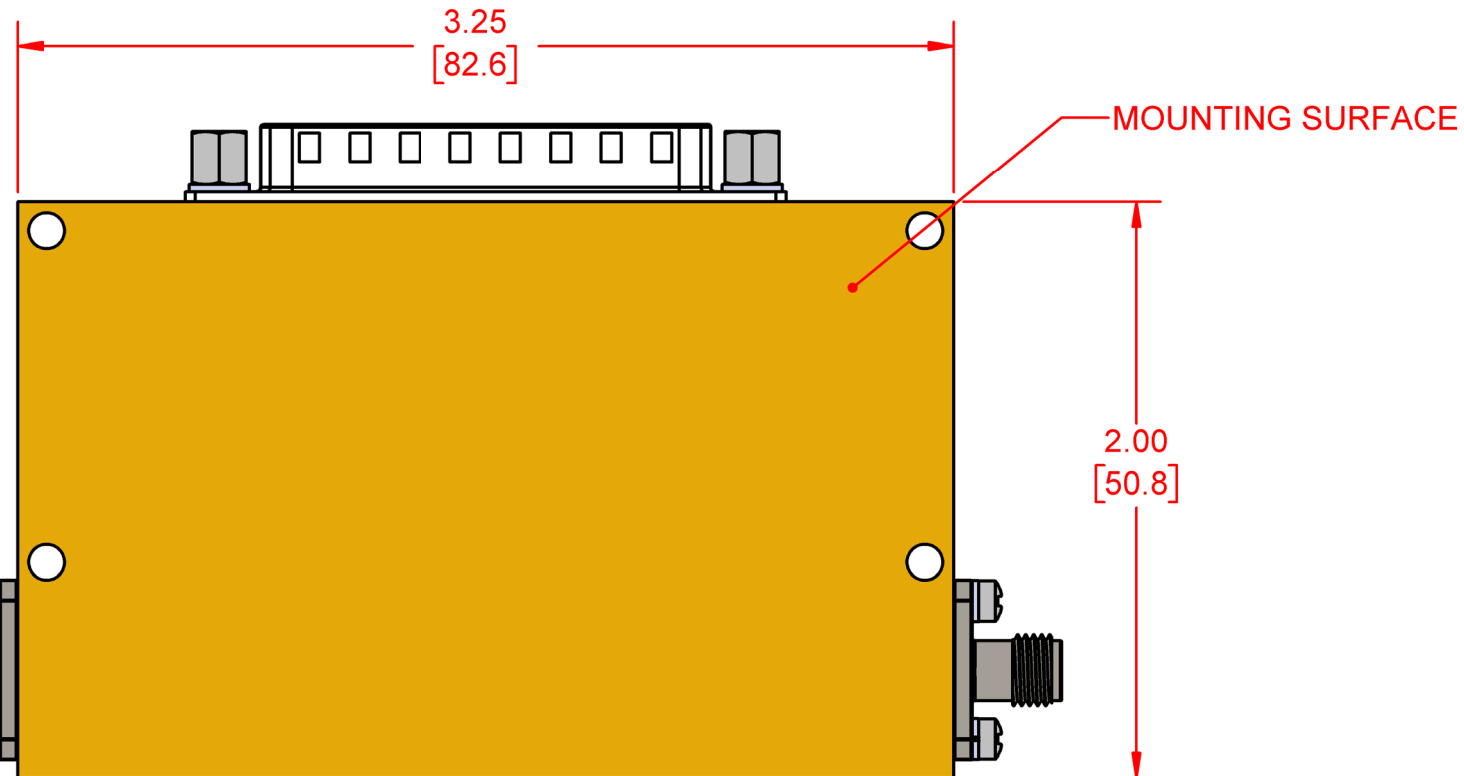
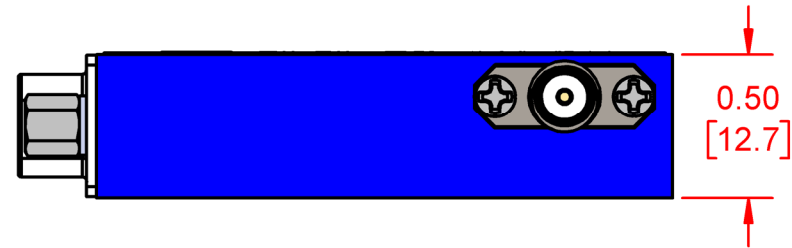
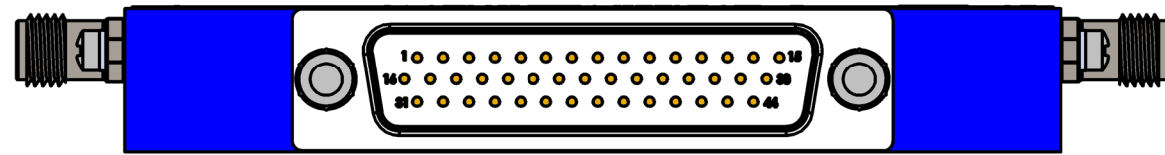
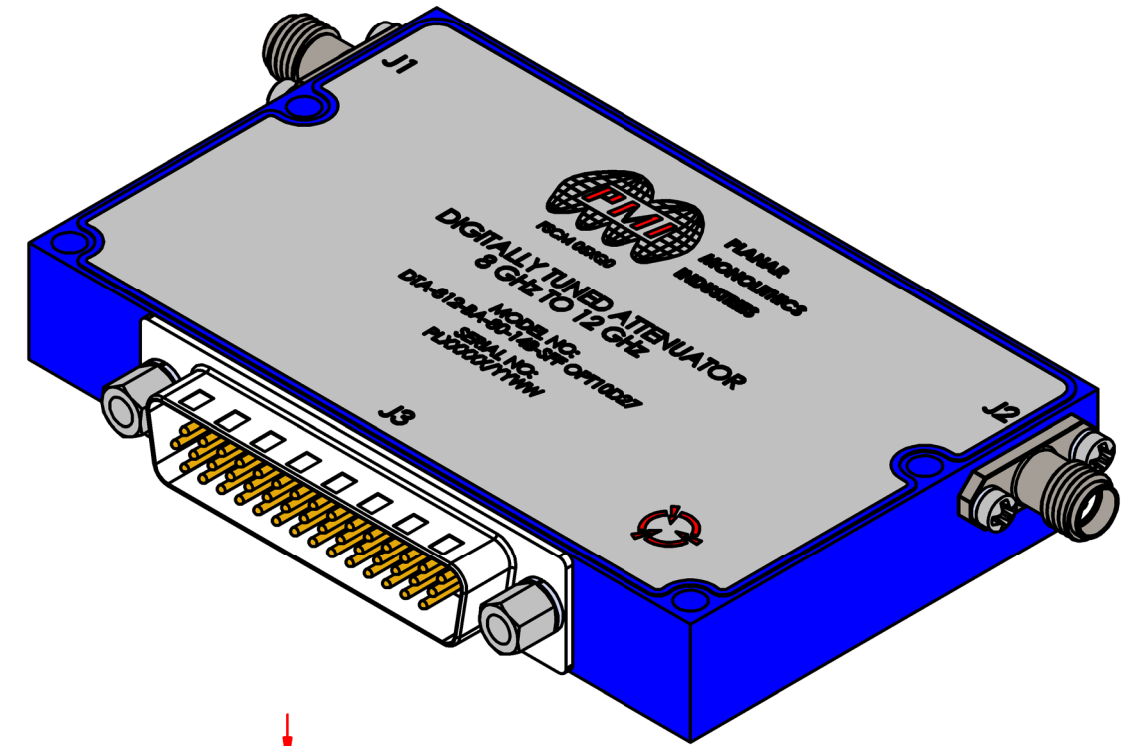
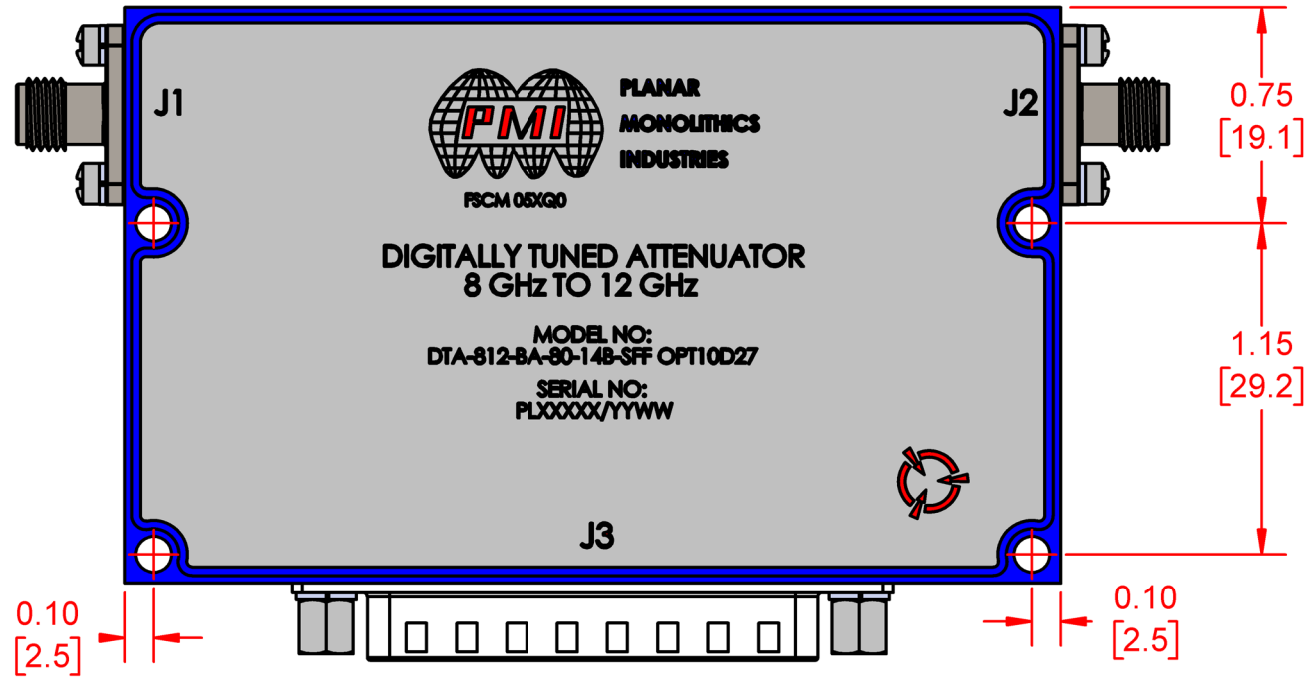

PMI CONFIDENTIAL AND PROPRIETARY

PLANAR MONOLITHICS INDUSTRIES, INC.
 7311-F GROVE ROAD
 FREDERICK, MARYLAND 21704 USA
 TEL: (301)-862-5019; FAX: (301)-862-1731
 WEB: www.pmi-rf.com; EMAIL: sales@pmi-rf.com
 ISO 9001 CERTIFIED

APPROVALS		DATE	TITLE	
DRAWN	R. SIRK	11/16/2021	OUTLINE	
REDRAWN			DTA-812-BA-80-14B-SFF OPT10D27	
ISSUED			SIZE	FSCM NO. DWG NO. REV.
			B	05XQ0 27041500 A2
SCALE 1:1			SHEET 2 OF 2	

UNLESS OTHERWISE SPECIFIED
 DIMENSIONS ARE IN INCHES
 TOLERANCES ARE:
 FRACTIONS DECIMALS ANGLES
 ± .XX ± 0.02 ±
 .XXX ± 0.01