

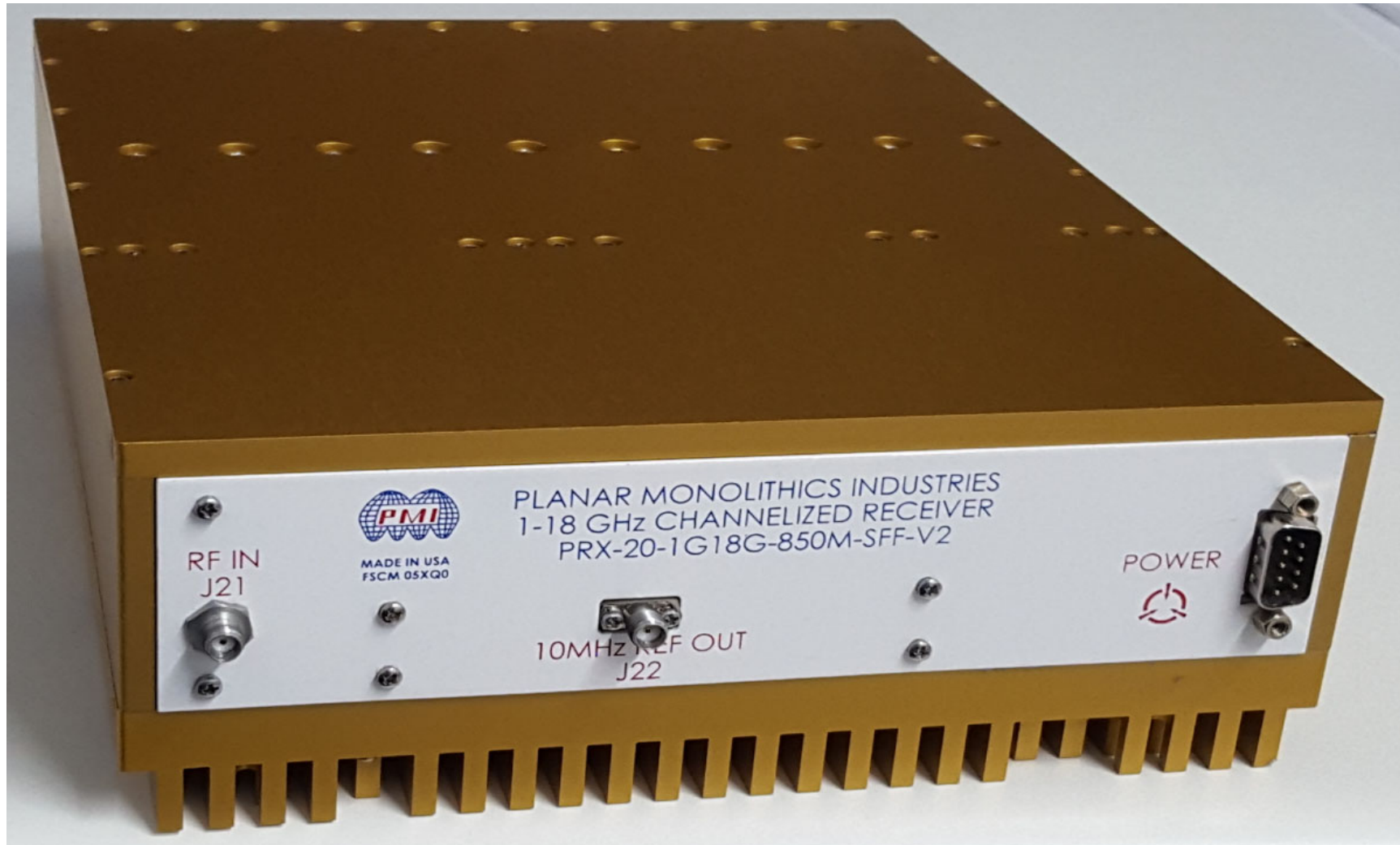

**TYPICAL CHARACTERISTICS
ON
PRX-20-1G18G-850M-SFF-V2**

PLANAR MONOLITHICS INDUSTRIES MODEL NUMBER PRX-20-1G18G-850M-SFF-V2 SERIAL NUMBER PL30754/2048 IS A CHANNELIZED RECEIVER WITH AN RF INPUT OF 1 TO 18 GHz. TWENTY OUTPUT CHANNELS ALLOW SIMULTANEOUS SIGNALS OF 850 MHz IN A 1 TO 4.4 GHz IF BAND TO BE OUTPUT FOR DIGITIZATION. AN INTERNAL REFERENCE IS INCLUDED TO LOCK THE VARIOUS LO's TO DOWN CONVERT THE SIGNAL INTO THE REQUIRED FREQUENCY BANDS.





**TYPICAL CHARACTERISTICS
ON
PRX-20-1G18G-850M-SFF-V2**

TABLE OF CONTENTS

1. OUTLINE DRAWING.....	PAGES 3-4
2. UNIT SUMMARY DATA.....	PAGES 5-6
3. SUMMARY DATA J1.....	PAGES 7-12
4. SUMMARY DATA J2.....	PAGES 13-18
5. SUMMARY DATA J3.....	PAGES 19-24
6. SUMMARY DATA J4.....	PAGES 25-30
7. SUMMARY DATA J5.....	PAGES 31-36
8. SUMMARY DATA J6.....	PAGES 37-42
9. SUMMARY DATA J7.....	PAGES 43-48
10. SUMMARY DATA J8.....	PAGES 49-54
11. SUMMARY DATA J9.....	PAGES 55-60
12. SUMMARY DATA J10.....	PAGES 61-66
13. SUMMARY DATA J11.....	PAGES 67-72
14. SUMMARY DATA J12.....	PAGES 73-78
15. SUMMARY DATA J13.....	PAGES 79-84
16. SUMMARY DATA J14.....	PAGES 85-90
17. SUMMARY DATA J15.....	PAGES 91-96
18. SUMMARY DATA J16.....	PAGES 97-102
19. SUMMARY DATA J17.....	PAGES 103-108
20. SUMMARY DATA J18.....	PAGES 109-114
21. SUMMARY DATA J19.....	PAGES 115-120
22. SUMMARY DATA J20.....	PAGES 121-126



TYPICAL CHARACTERISTICS ON PRX-20-1G18G-850M-SFF-V2

OUTLINE

DESCRIPTION:

PLANAR MONOLITHICS INDUSTRIES MODEL NUMBER PRX-20-1G18G-850M-SFF-V2 IS A CHANNELIZED RECEIVER WITH AN RF INPUT OF 1 TO 18 GHz. TWENTY OUTPUT CHANNELS ALLOW SIMULTANEOUS SIGNALS OF 850MHz IN A 1 TO 4.4 GHz IF BAND TO BE OUTPUT FOR DIGITIZATION. AN INTERNAL REFERENCE IS INCLUDED TO LOCK THE VARIOUS LO'S TO DOWN CONVERT THE SIGNAL INTO THE REQUIRED FREQUENCY BANDS.

SPECIFICATIONS @ 25°C:

RF INPUT

- FREQUENCY: 1 TO 18 GHz
- INPUT POWER: -80 TO 0 dBm TYP
- VSWR: 2.5:1 TYP

RF OUTPUTS

- FREQUENCY: J1, J5, J9, J13, J17: 1.00 - 1.85 GHz
J2, J6, J10, J14, J18: 1.85 - 2.70 GHz
J3, J7, J11, J15, J19: 2.70 - 3.55 GHz
J4, J8, J12, J16, J20: 3.55 - 4.40 GHz
- CHANNELS: 20
- GAIN: J1 TO J4: -3 dB TO +3 dB TYP
J5 TO J8: -3 dB TO +3 dB GOAL, -6 dB TO +3 dB TYP
J9 TO J12: -3 dB TO +3 dB GOAL, -9 dB TO +3 dB TYP
J13 TO J16: -3 dB TO +3 dB GOAL, -9 dB TO +3 dB TYP
J17 TO J20: -3 dB TO +3 dB GOAL, -10 dB TO +3 dB TYP
- PASSBAND: 870 - 1000 MHz TYP
- STOPBAND: 1.4 GHz MAX
- NOISE FIGURE: J1 TO J4: 25 dB TYP
J5 TO J8: 33 dB TYP
J9 TO J12: 35 dB TYP
J13 TO J16: 35 dB TYP
J17 TO J20: 38 dB TYP
- OUTPUT IP3: +30 dBm TYP

REFERENCE OUTPUT

- FREQUENCY: 10 MHz
- OUTPUT POWER: +20 dBm
- STABILITY: ± 0.1 PPM
- AGING: ± 30 PPB YEARLY

CONNECTORS:

- INPUT: SMA-F
- OUTPUTS: SMA-F
- REFERENCE OUTPUT: SMA-F
- POWER: 9-PIN D-SUB M
- POWER SUPPLY: +12V ± 5% @ 3A MAX
+7V ± 5% @ 5.5A MAX
-5V ± 5% @ 1A MAX

- SIZE: 10.00" X 8.00" X 3.00"
- FINISH: GOLD ANODIZED, MIL-A-8625 TYPE II, CLASS 2
DYED GOLD, NICKEL ACETATE SEAL PER MIL-A-8625 PARAGRAPH 3.8.1.2

ENVIRONMENTAL RATINGS:

- TEMPERATURE: -40°C TO +85°C (OPERATING)
WITH 145 CFM AIRFLOW ACROSS HEATSINK
-40°C TO +85°C (STORAGE)
- HUMIDITY: MIL-STD-810, 0 TO 95% NON-CONDENSING
- VIBRATION: DESIGNED TO MEET CHART 6.4 IN DOCUMENT 3000135-07
- ALTITUDE: MIL-STD-810, 15000 FT
- ACOUSTIC: DESIGNED TO MEET CHART 6.5 IN DOCUMENT 3000135-07

NOTE SPECIFICATIONS WILL VARY OVER OPERATING TEMPERATURE
NOTE: CHANGES TO DRAWING OR SPECIFICATIONS MUST BE APPROVED BY END USER.

DB9 PINOUT	
PIN	FUNCTION
1	GND
2	GND
3	GND
4	-5V
5	GND
6	+7V
7	+7V
8	+12V
9	+12V

ZONE	REV.	DESCRIPTION	DATE	APPROVED
	A1	ORIGINAL RELEASE	9/9/2009	

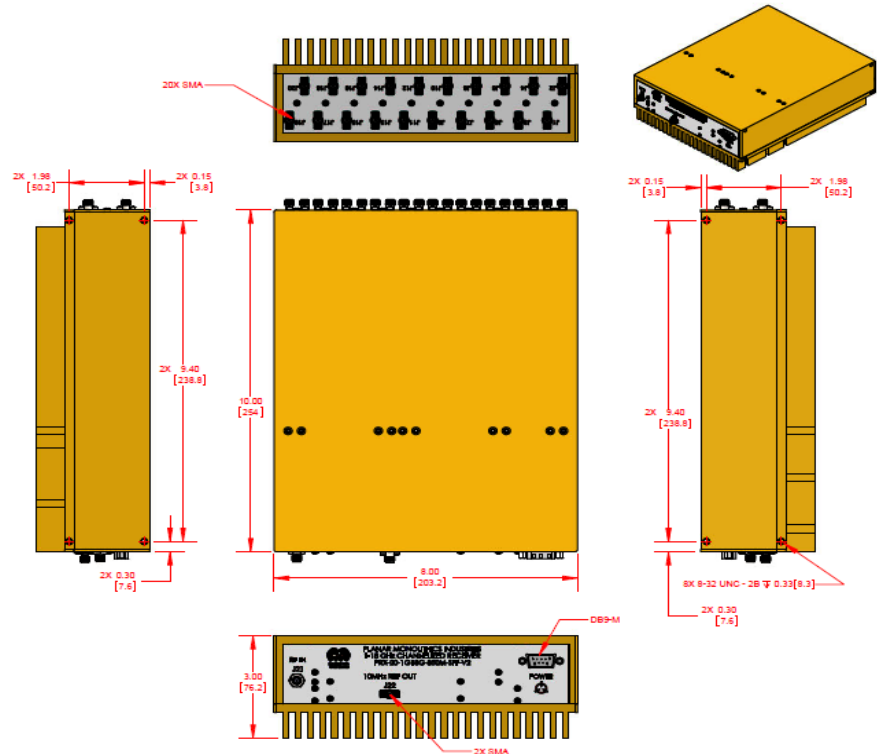

PMI CONFIDENTIAL AND PROPRIETARY

PLANAR MONOLITHICS INDUSTRIES, INC. 3511-F GROVE ROAD FREDERICK, MARYLAND 21704 USA TEL: (301)662-5019 FAX: (301)662-1731 WEB: www.pmi-f.com, EMAIL: sales@pmi-f.com 100-9001-1 (REV. 09/09)		TITLE OUTLINE PRX-20-1G18G-850M-SFF-V2 SIZE: B PFORM NO.: 05XQ0 DWG NO.: 27039280 SCALE: 1:3	APPROVALS DRAWN: D. DURBIN RELEASER: ISSUED: DATE: 9/9/2009 REV: A1 SHEET 1 OF 3
---	--	---	---



TYPICAL CHARACTERISTICS ON PRX-20-1G18G-850M-SFF-V2

OUTLINE PAGE 2

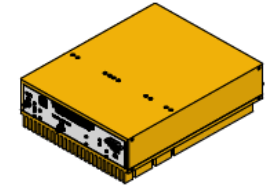
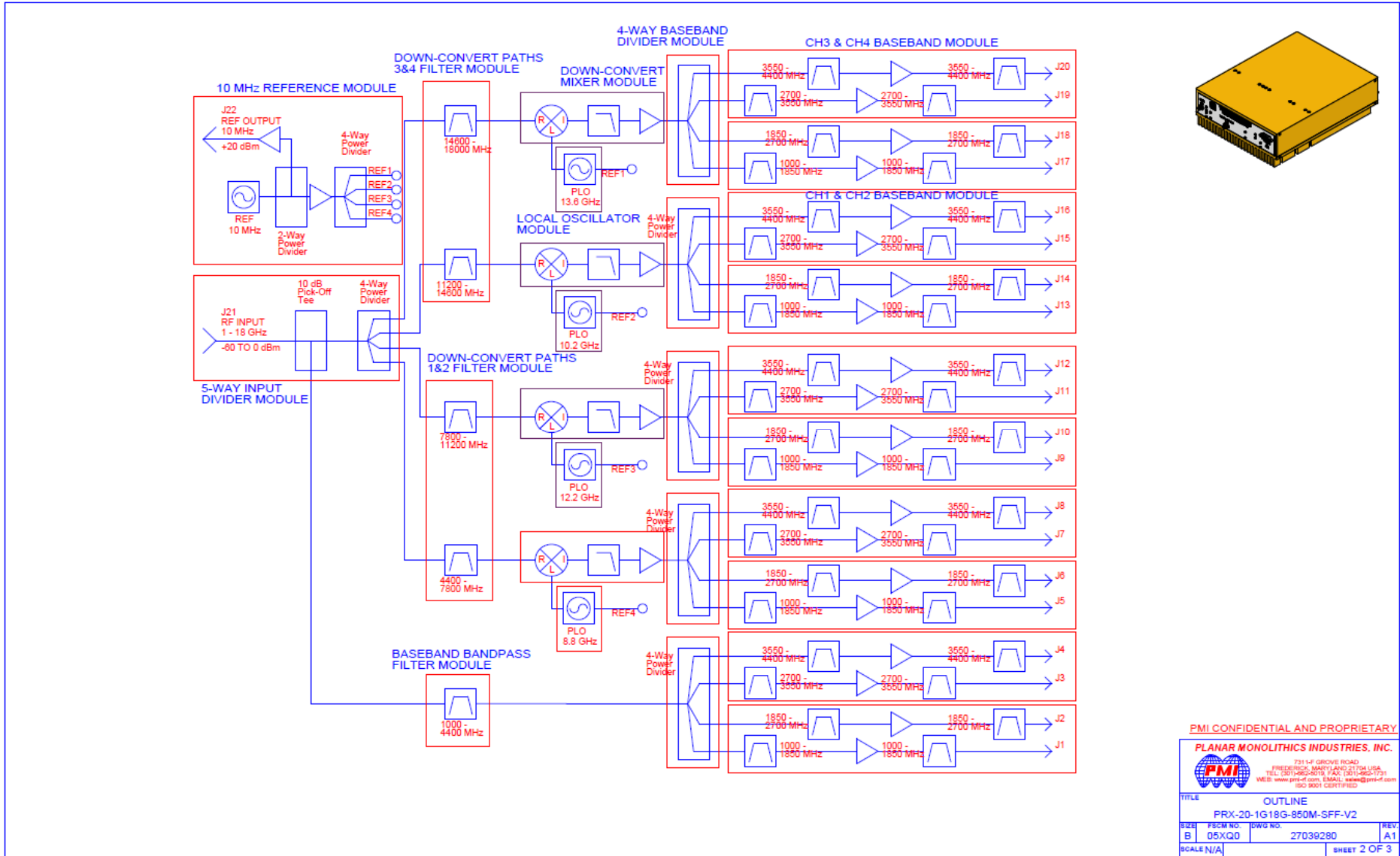

PMI CONFIDENTIAL AND PROPRIETARY

PLANAR MONOLITHICS INDUSTRIES, INC.

7311-F GROVE ROAD
FREDERICK, MARYLAND 21704 USA
TEL: (301)662-1731 FAX: (301)662-1731
WEB: www.pmi-usa.com EMAIL: sales@pmi-usa.com
ISO 9001 CERTIFIED

TITLE		OUTLINE	
PRX-20-1G18G-850M-SFF-V2			
SIZE	FORM NO.	DRG NO.	REV.
B	05XG0	27038280	A1
SCALE N/A			SHEET 2 OF 3

7311-F Grove Road Frederick, MD 21704 USA Phone (301)662-5019 Fax: (301)662-1731



**TYPICAL CHARACTERISTICS
ON
PRX-20-1G18G-850M-SFF-V2**

CUSTOMER: _____
 SO: _____
 MODEL NUMBER: **PRX-20-1G18G-850M-SFF-V2**
 SERIAL NUMBER: **PL30754/2048**

TESTED BY: **RCombs**
 TEMPERATURE: **+25 C**
 DATE: **12/21/2020**
 DRAWING NO: **27639280** REV: **A1**

SUMMARY DATA FOR UNIT

TEST NO	PARAMETERS	SPECIFIED VALUE	TEST RESULTS
			+25°C
1	Frequency Range J1:	1.0 GHz to 18.0 GHz	1.0 GHz to 18.0 GHz
2	Input VSWR J21:	2.5 : 1 Typ	1.9 : 1
3	J21 Worst Case Spur: (Powered, No RF Signal)	Not Specified	-80.21 dBm @ 12.2 GHz
4	REF Out Frequency J22:	10.00 MHz	10.00 MHz
5	REF Out Power J22:	+20 dBm Typ	21.6 dBm
6	DC Power:	+7V @ 5.5A Max	4.14 A
		+12V @ 3 A Max	1.47 A

QA/QC Approval:  **PMI QA 2**

Date: 12/21/20

7311-F Grove Road Frederick, MD 21704 USA Phone (301)662-5019 Fax: (301)662-1731



**TYPICAL CHARACTERISTICS
ON
PRX-20-1G18G-850M-SFF-V2**

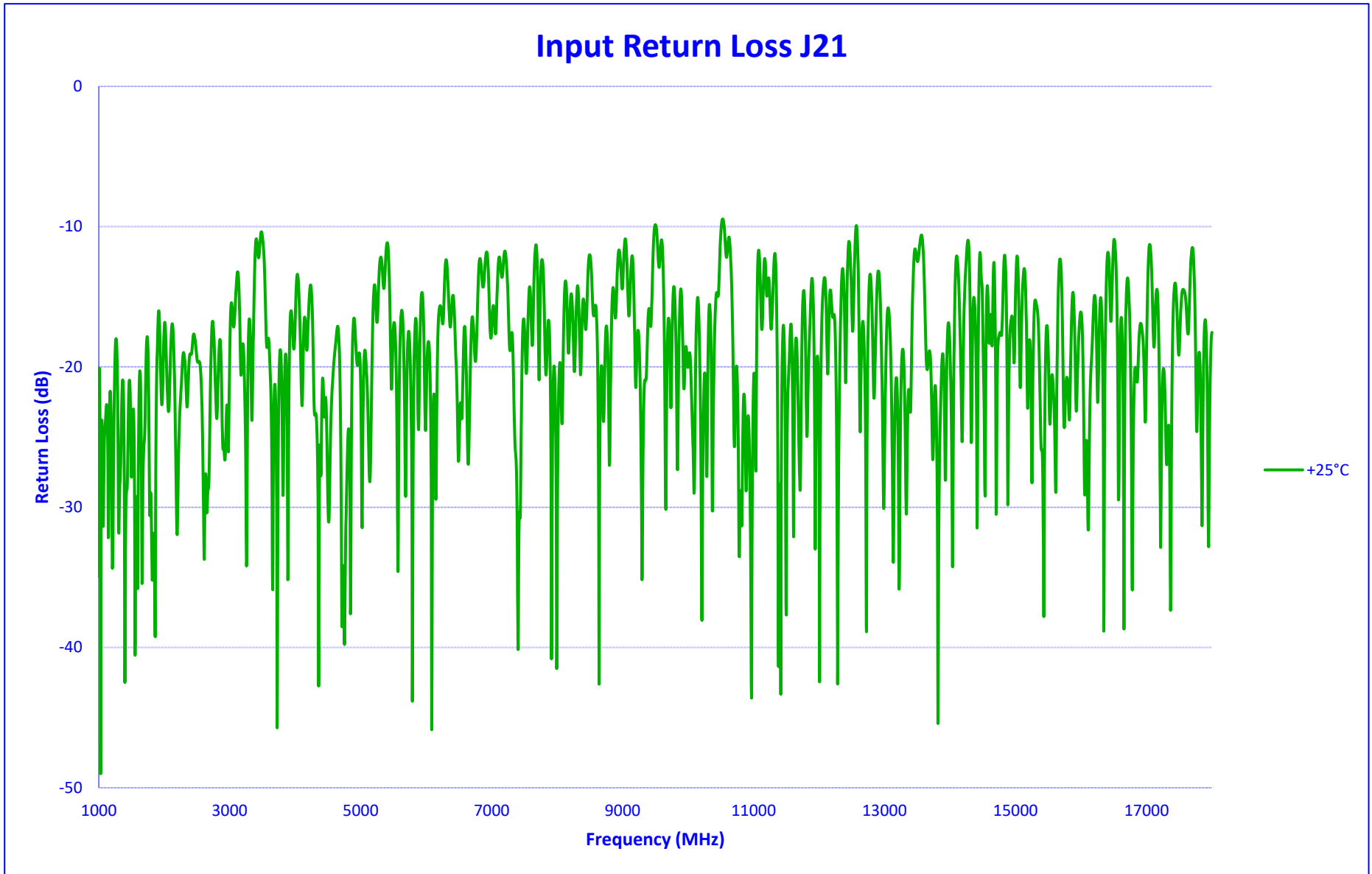



**TYPICAL CHARACTERISTICS
ON
PRX-20-1G18G-850M-SFF-V2**

SUMMARY DATA FOR J1

TEST NO	PARAMETERS	SPECIFIED VALUE	TEST RESULTS
Input Frequency: 1000 - 1850 MHz			+25°C
1	Frequency Range J1:	1000 MHz to 1850 MHz	1000 MHz to 1850 MHz
2	Power Input:	-60 to 0 dBm	-60 to 0 dBm
3	Gain J1:	0 dB ± 3 dB	0.2 ± 2.3 dB
4	Noise Figure J1:	25 dB Typ	21.74 dB
5	Output IP3 J1:	30 dBm Typ	37.17 dBm
6	Output VSWR J1:	2 : 1 Max	1.4 : 1
7	Passband J1:	Lower 990 MHz Typ	981 MHz
		Upper 1860 MHz Typ	1870 MHz
		Passband 870 MHz Typ	889 MHz
8	Stopband J1:	Lower 890 MHz Typ	948 MHz
		Upper 1980 MHz Typ	1940 MHz
		Stopband 1400 MHz Max	992 MHz
9	Worst Case Spur: (Powered, No RF Input)	-60 dBm Typ	None
10	Inband Worst Case Spur: (1-18 GHz RF Input)	-60 dBm Typ	None



**TYPICAL CHARACTERISTICS
ON
PRX-20-1G18G-850M-SFF-V2**

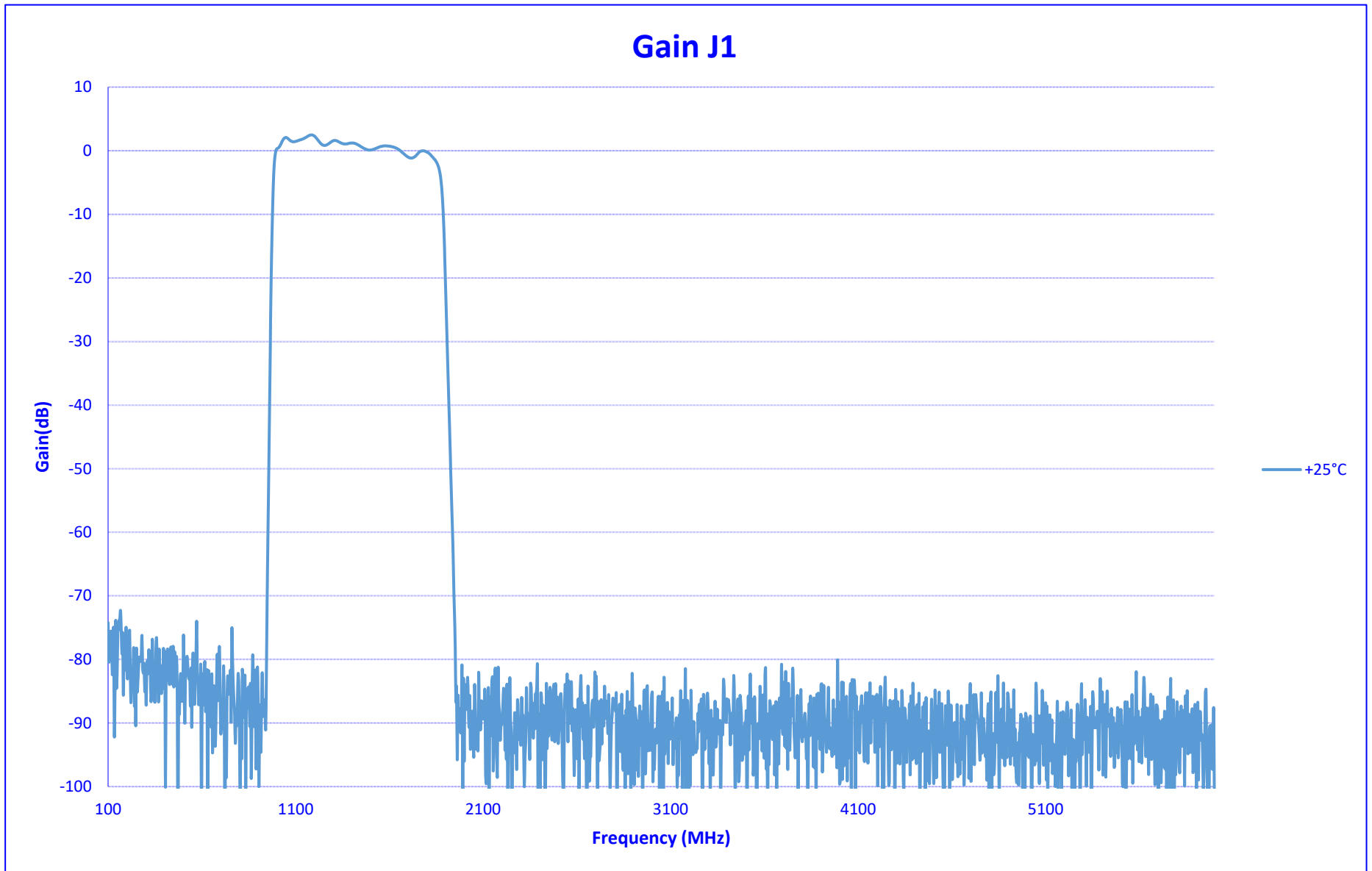



TYPICAL CHARACTERISTICS
ON
PRX-20-1G18G-850M-SFF-V2

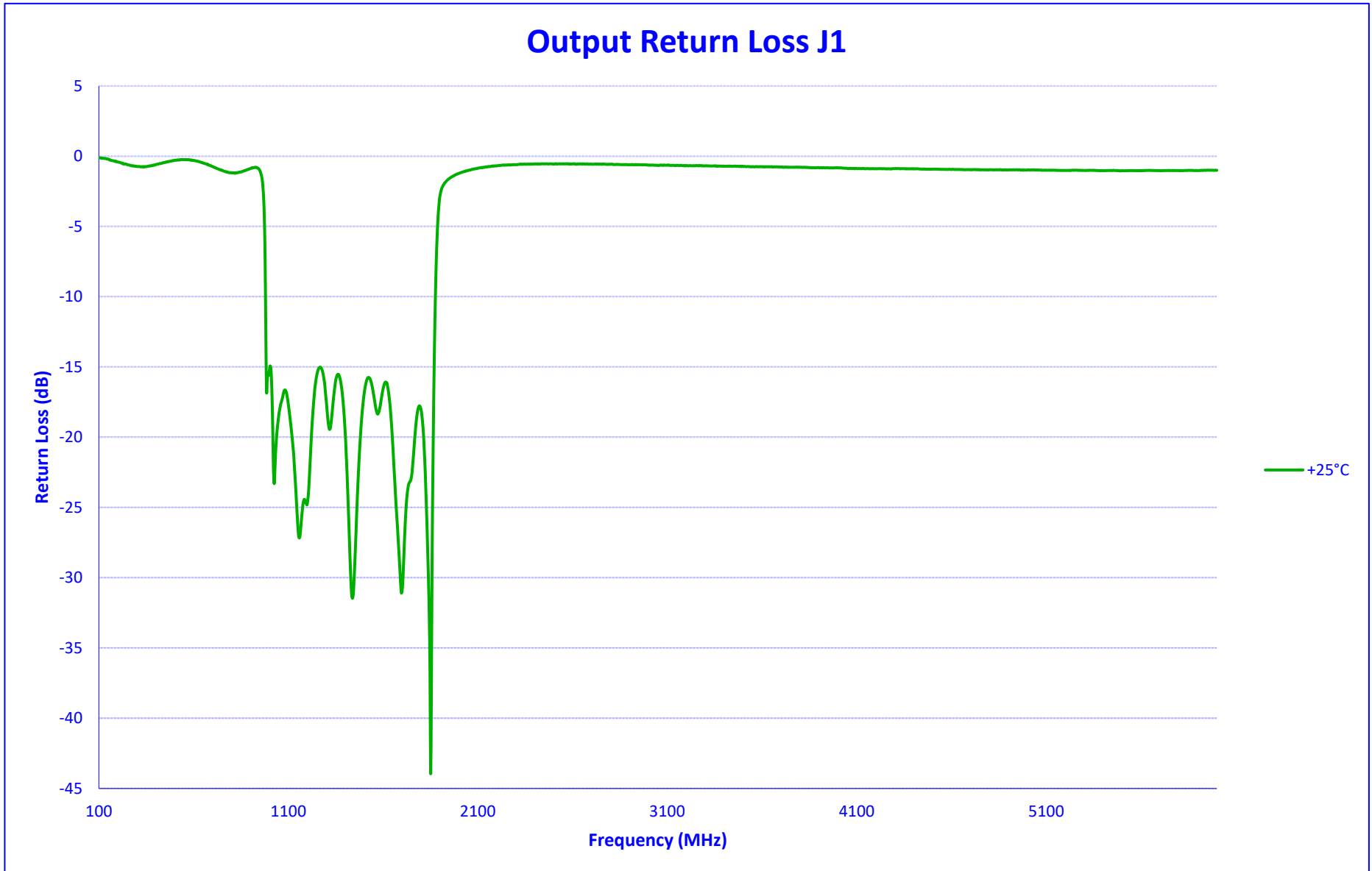



**TYPICAL CHARACTERISTICS
ON
PRX-20-1G18G-850M-SFF-V2**

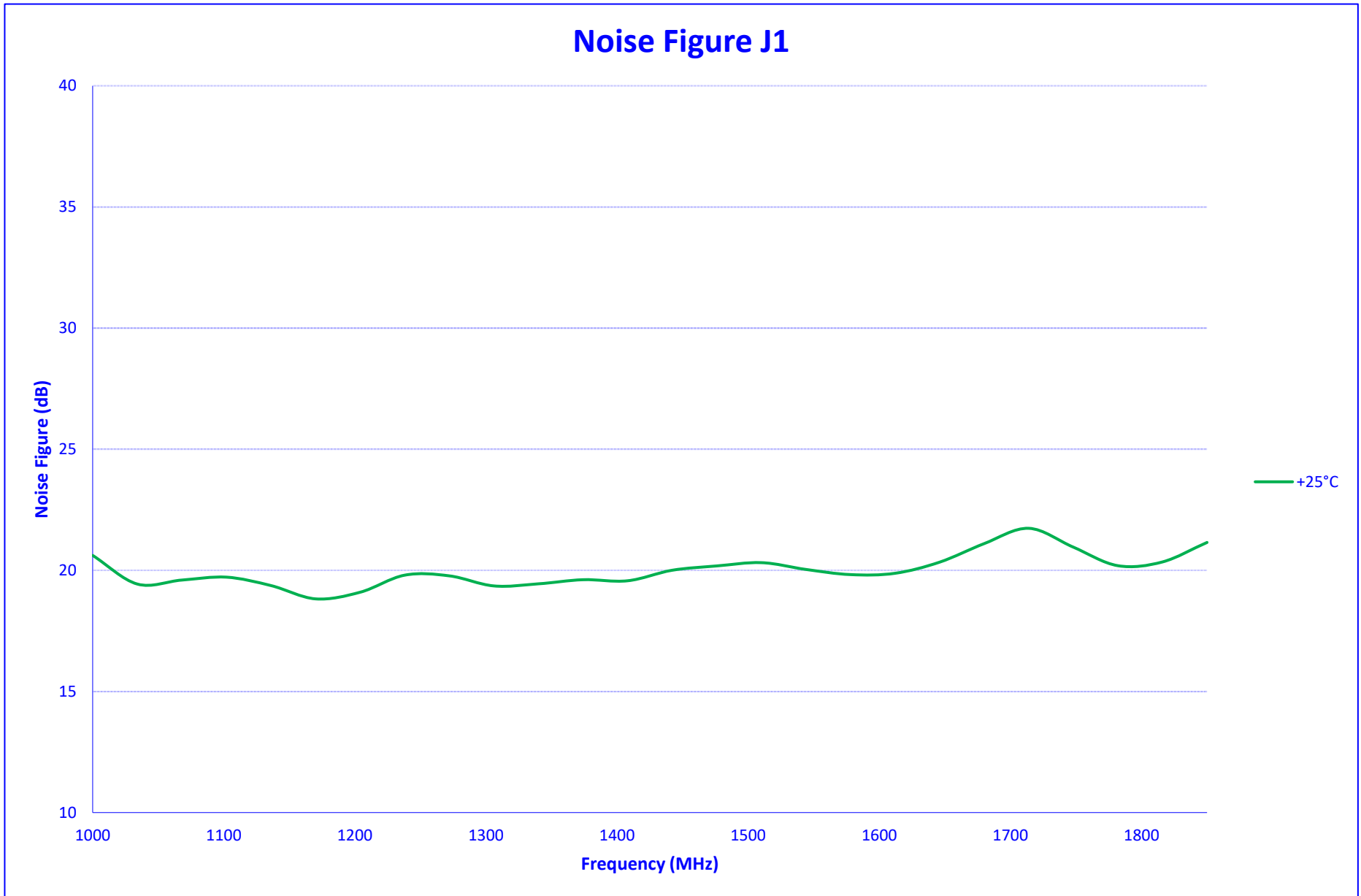



**TYPICAL CHARACTERISTICS
ON
PRX-20-1G18G-850M-SFF-V2**

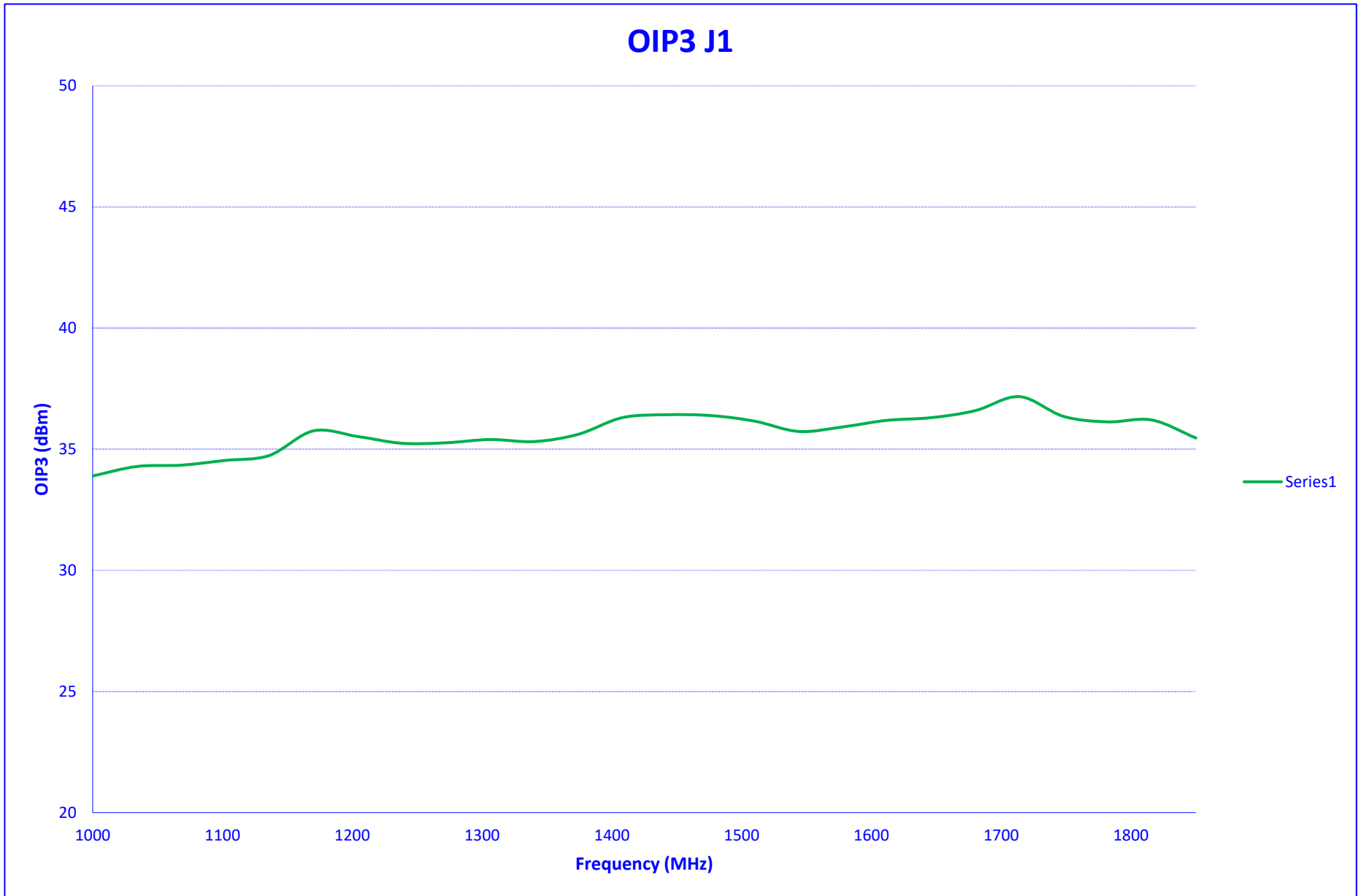



**TYPICAL CHARACTERISTICS
ON
PRX-20-1G18G-850M-SFF-V2**

SUMMARY DATA FOR J2

TEST NO	PARAMETERS	SPECIFIED VALUE	TEST RESULTS
Input Frequency: 1850 - 2700 MHz			+25°C
1	Frequency Range J2:	1850 MHz to 2700 MHz	1850 MHz to 2700 MHz
2	Power Input:	-60 to 0 dBm	-60 to 0 dBm
3	Gain J2:	0 dB ± 3 dB	-0.2 ± 1.4 dB
4	Noise Figure J2:	25 dB Typ	21.33 dB
5	Output IP3 J2:	30 dBm Typ	39.64 dBm
6	Output VSWR J2:	2 : 1 Max	1.3 : 1
7	Passband J2:	Lower 1840 MHz Typ	1811 MHz
		Upper 2710 MHz Typ	2726 MHz
		Passband 870 MHz Typ	915 MHz
8	Stopband J2:	Lower 1635 MHz Typ	1723 MHz
		Upper 2915 MHz Typ	2832 MHz
		Stopband 1400 MHz Max	1110 MHz
9	Worst Case Spur: (Powered, No RF Input)	-60 dBm Typ	None
10	Inband Worst Case Spur: (1-18 GHz RF Input)	-60 dBm Typ	None



**TYPICAL CHARACTERISTICS
ON
PRX-20-1G18G-850M-SFF-V2**

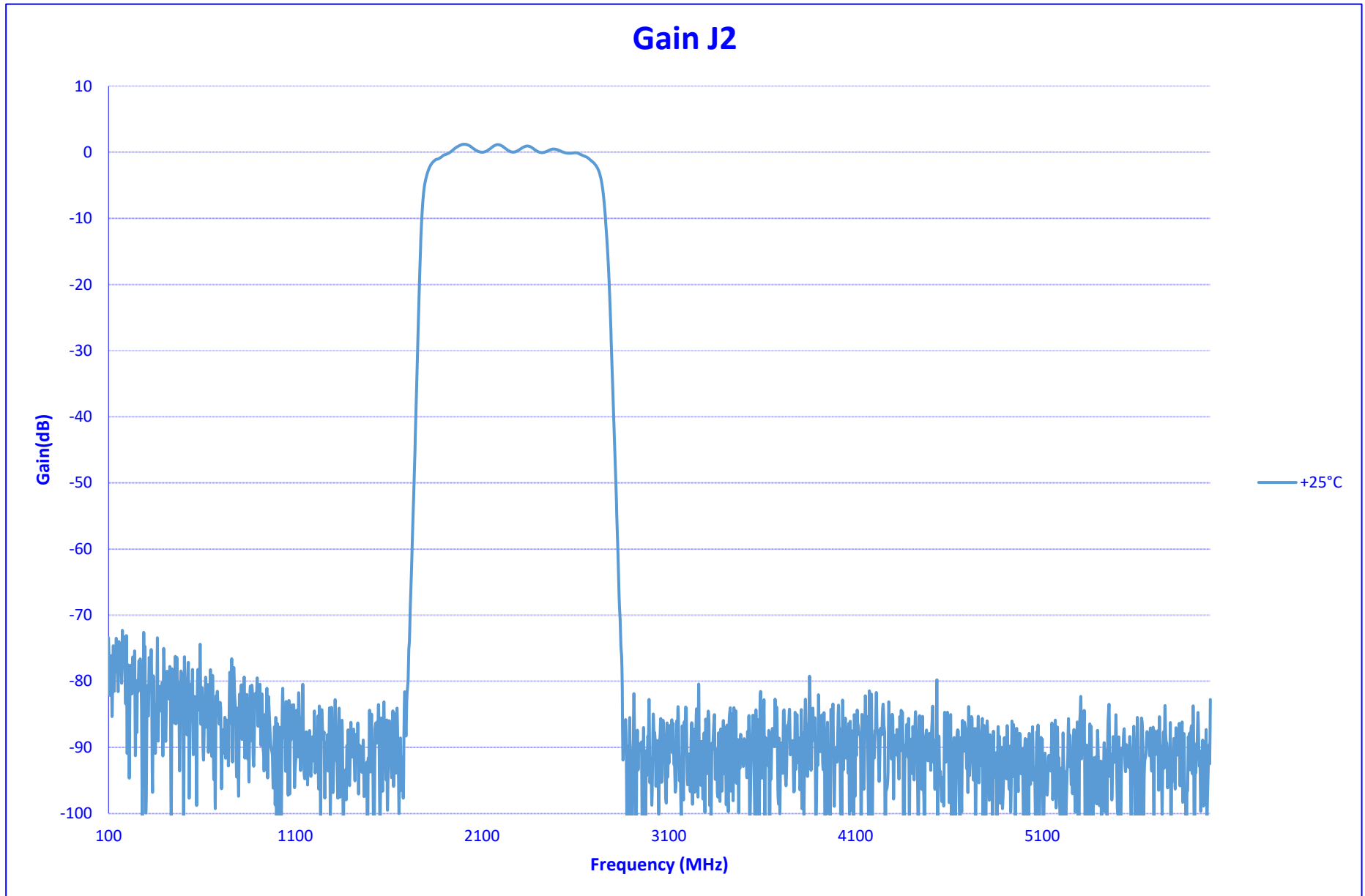



TYPICAL CHARACTERISTICS
ON
PRX-20-1G18G-850M-SFF-V2

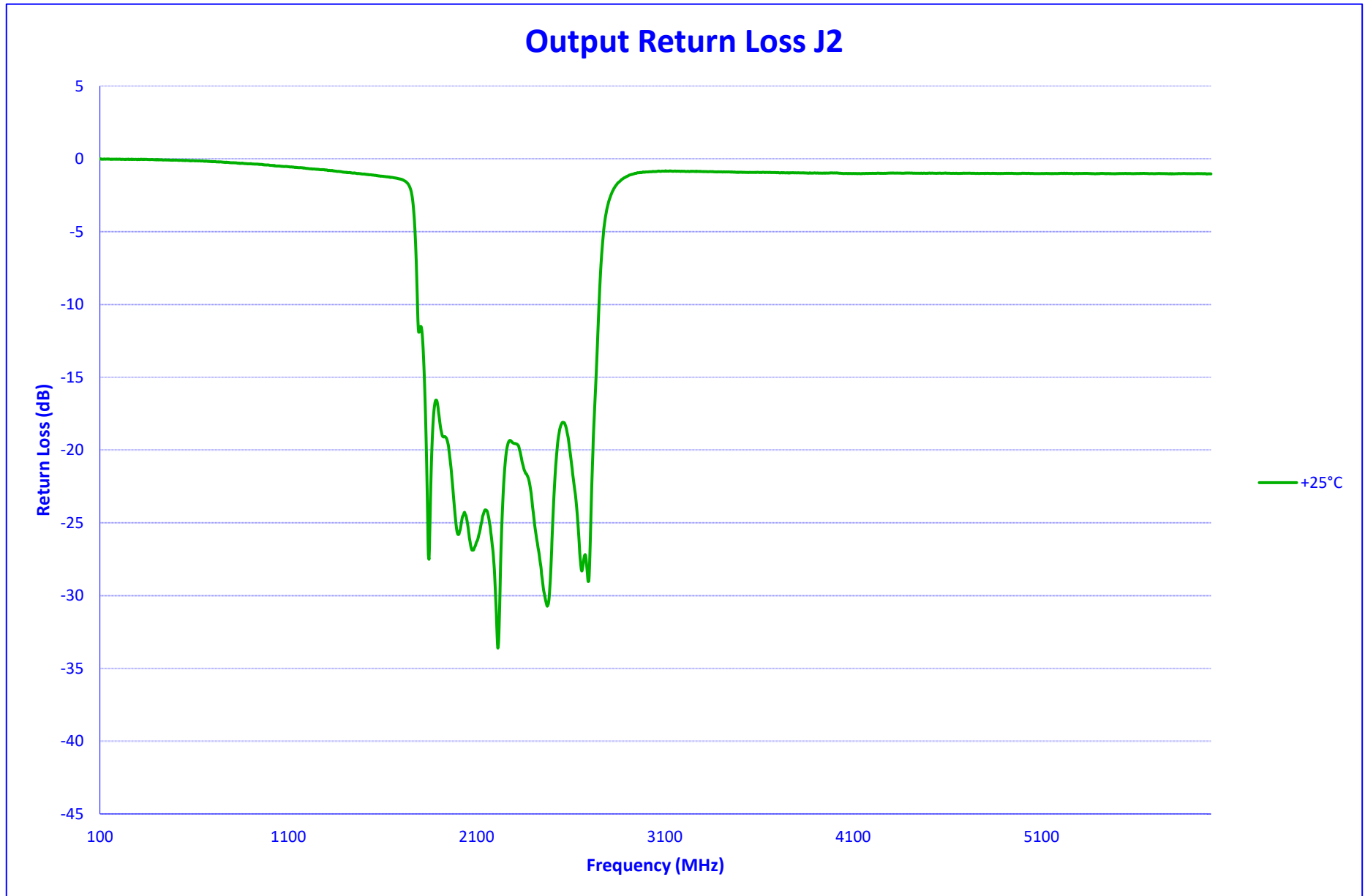



**TYPICAL CHARACTERISTICS
ON
PRX-20-1G18G-850M-SFF-V2**

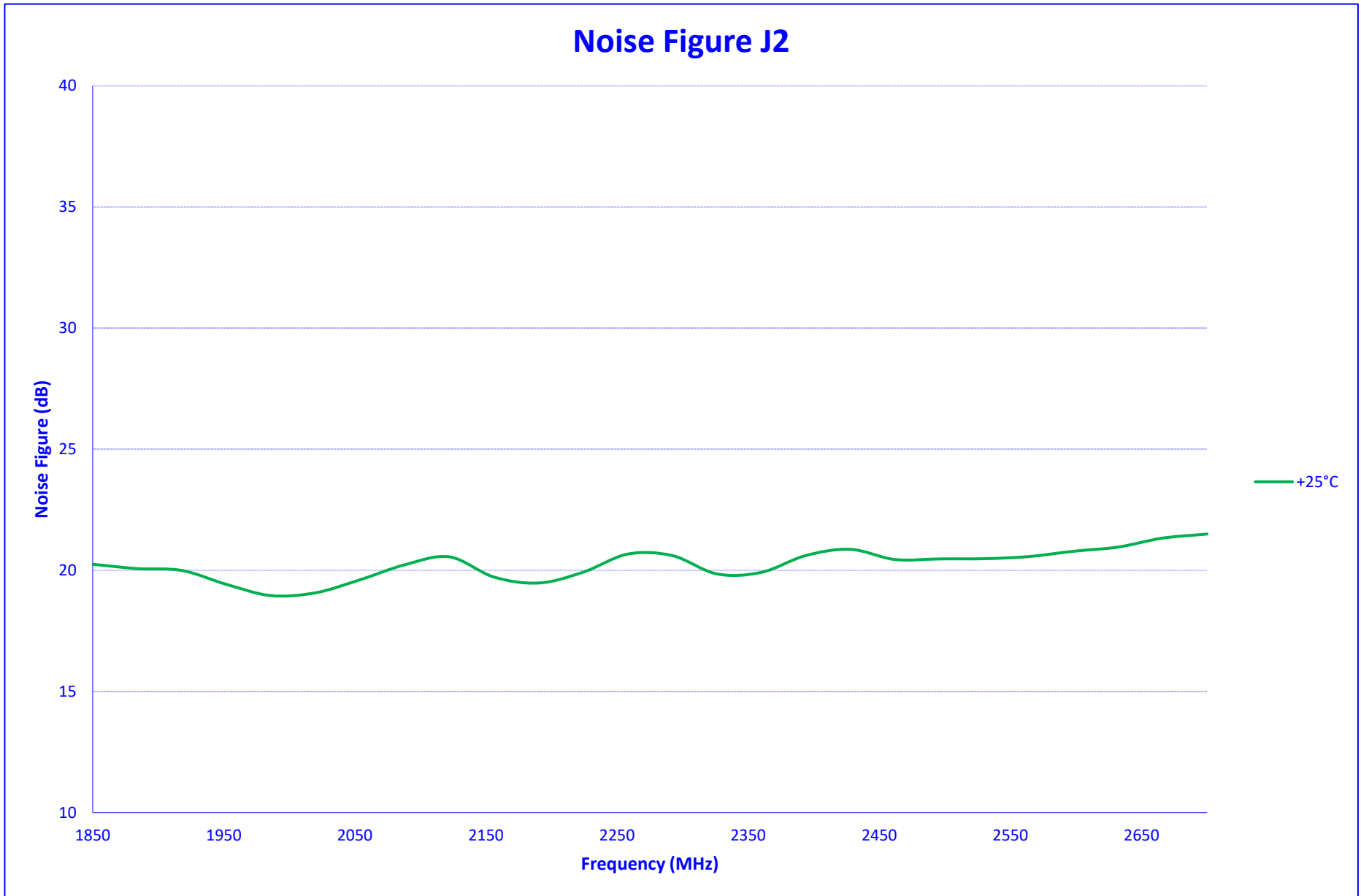



**TYPICAL CHARACTERISTICS
ON
PRX-20-1G18G-850M-SFF-V2**

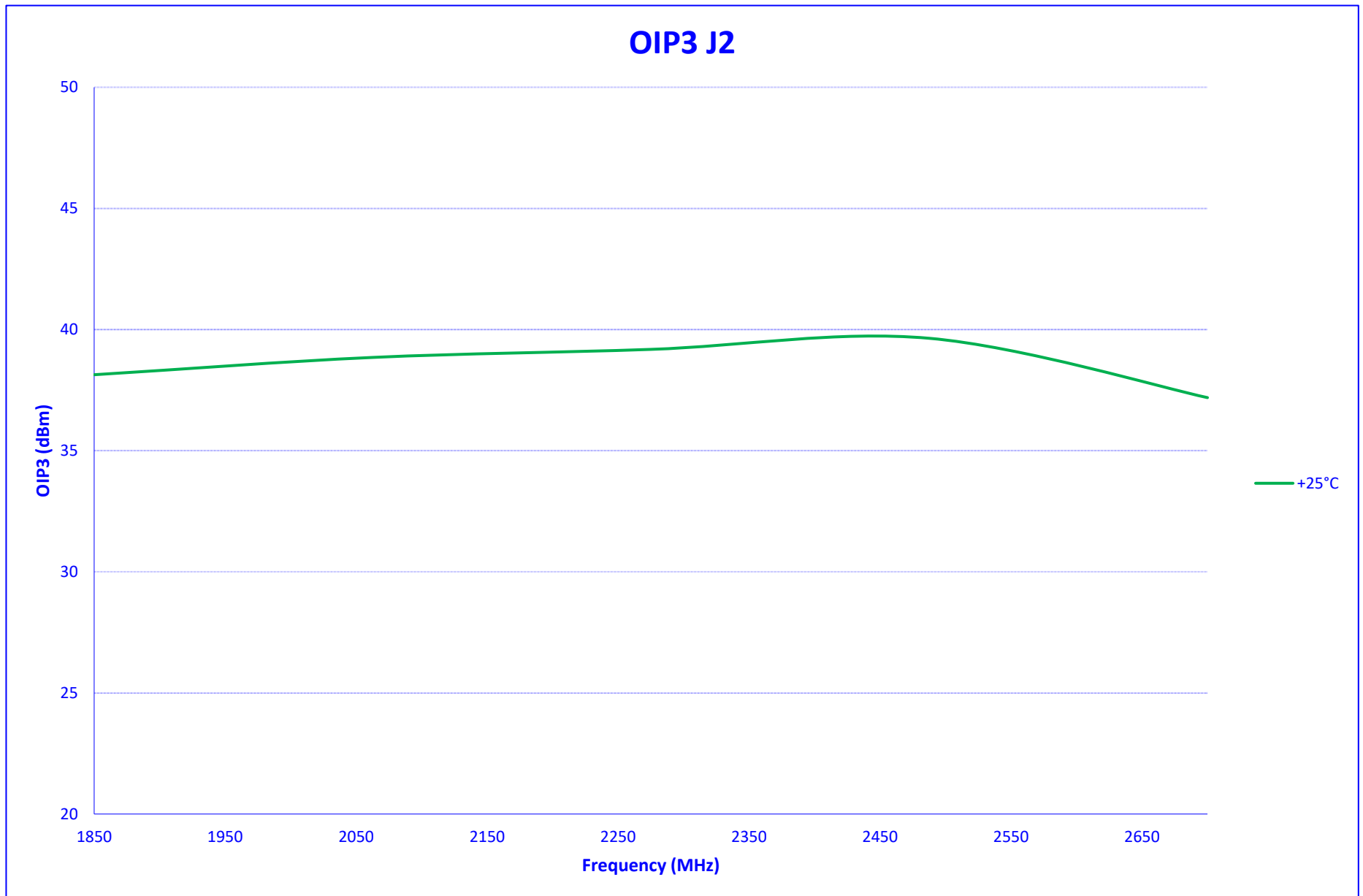



TYPICAL CHARACTERISTICS
ON
PRX-20-1G18G-850M-SFF-V2

IN BAND SPURS J2

25°C

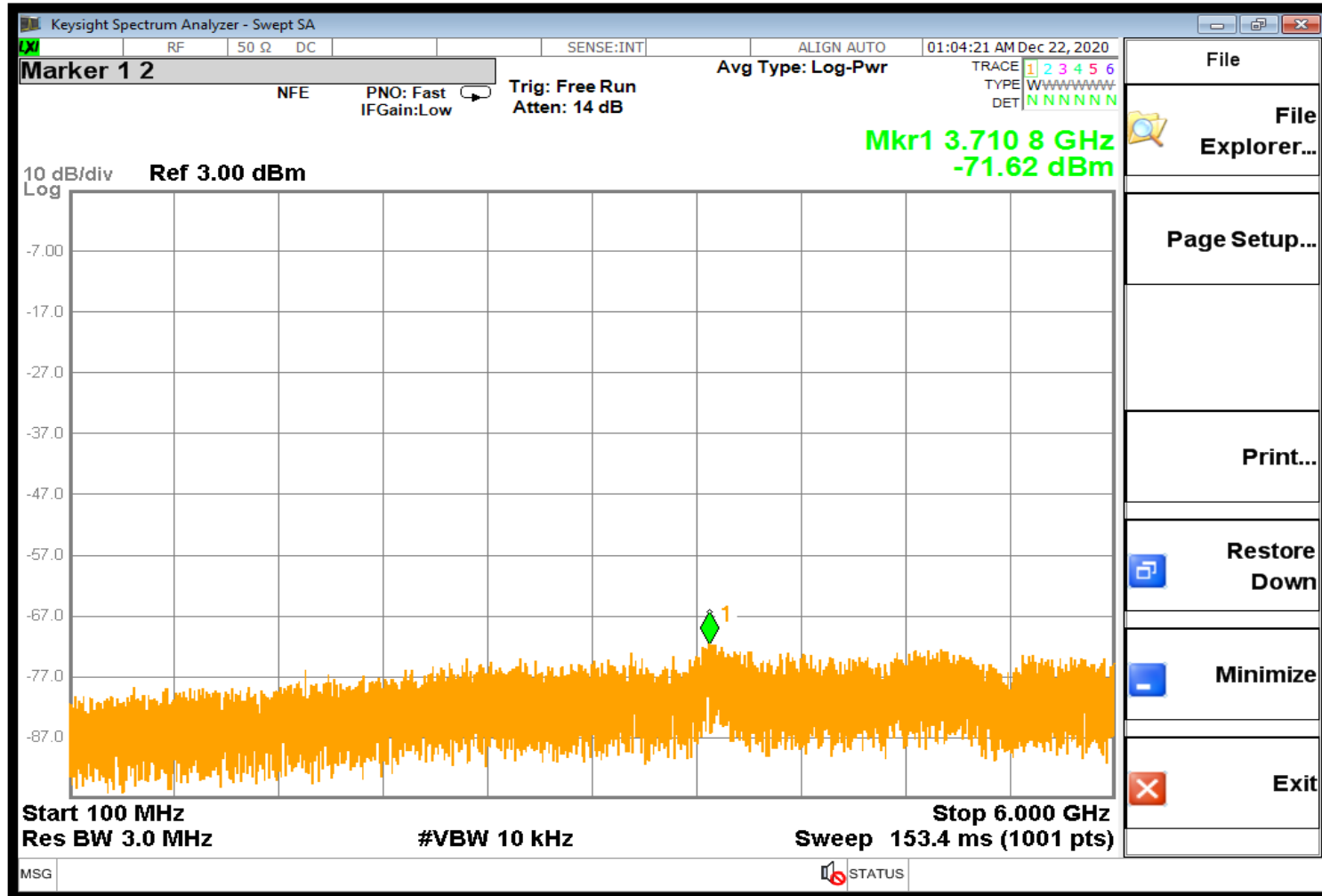



**TYPICAL CHARACTERISTICS
ON
PRX-20-1G18G-850M-SFF-V2**

SUMMARY DATA FOR J3

TEST NO	PARAMETERS	SPECIFIED VALUE	TEST RESULTS
Input Frequency: 2700 - 3550 MHz			+25°C
1	Frequency Range J3:	2700 MHz to 3550 MHz	2700 MHz to 3550 MHz
2	Power Input:	-60 to 0 dBm	-60 to 0 dBm
3	Gain J3:	0 dB ± 3 dB	-1.3 ± 1.7 dB
4	Noise Figure J3:	25 dB Typ	23.15 dB
5	Output IP3 J3:	30 dBm Typ	39.4 dBm
6	Output VSWR J3:	2 : 1 Max	1.4 : 1
7	Passband J3:	Lower 2690 MHz Typ	2652 MHz
		Upper 3560 MHz Typ	3588 MHz
		Passband 870 MHz Typ	937 MHz
8	Stopband J3:	Lower 2485 MHz Typ	2556 MHz
		Upper 3765 MHz Typ	3714 MHz
		Stopband 1400 MHz Max	1158 MHz
9	Worst Case Spur: (Powered, No RF Input)	-60 dBm Typ	None
10	Inband Worst Case Spur: (1-18 GHz RF Input)	-60 dBm Typ	None



TYPICAL CHARACTERISTICS
ON
PRX-20-1G18G-850M-SFF-V2

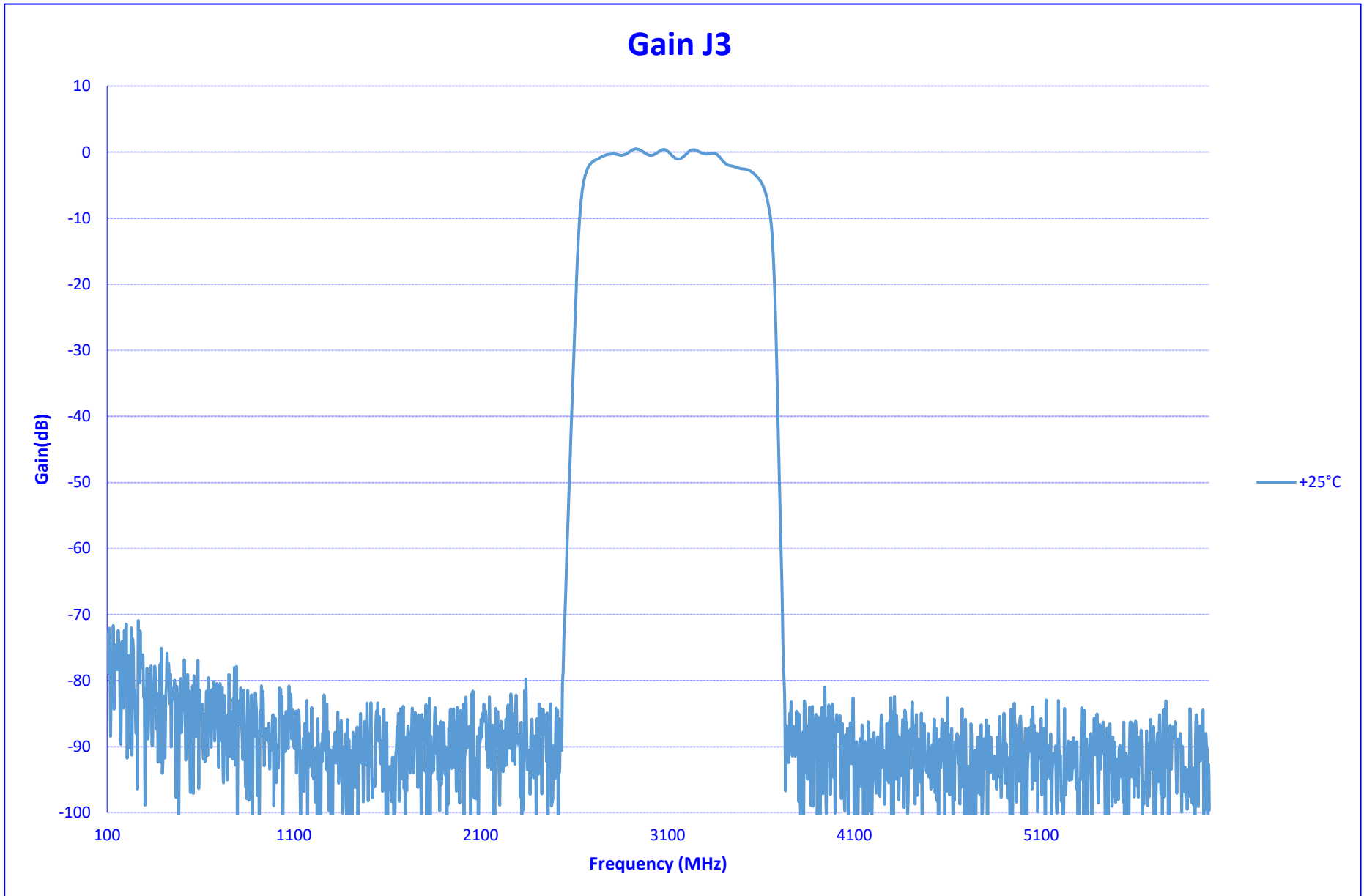



TYPICAL CHARACTERISTICS
ON
PRX-20-1G18G-850M-SFF-V2

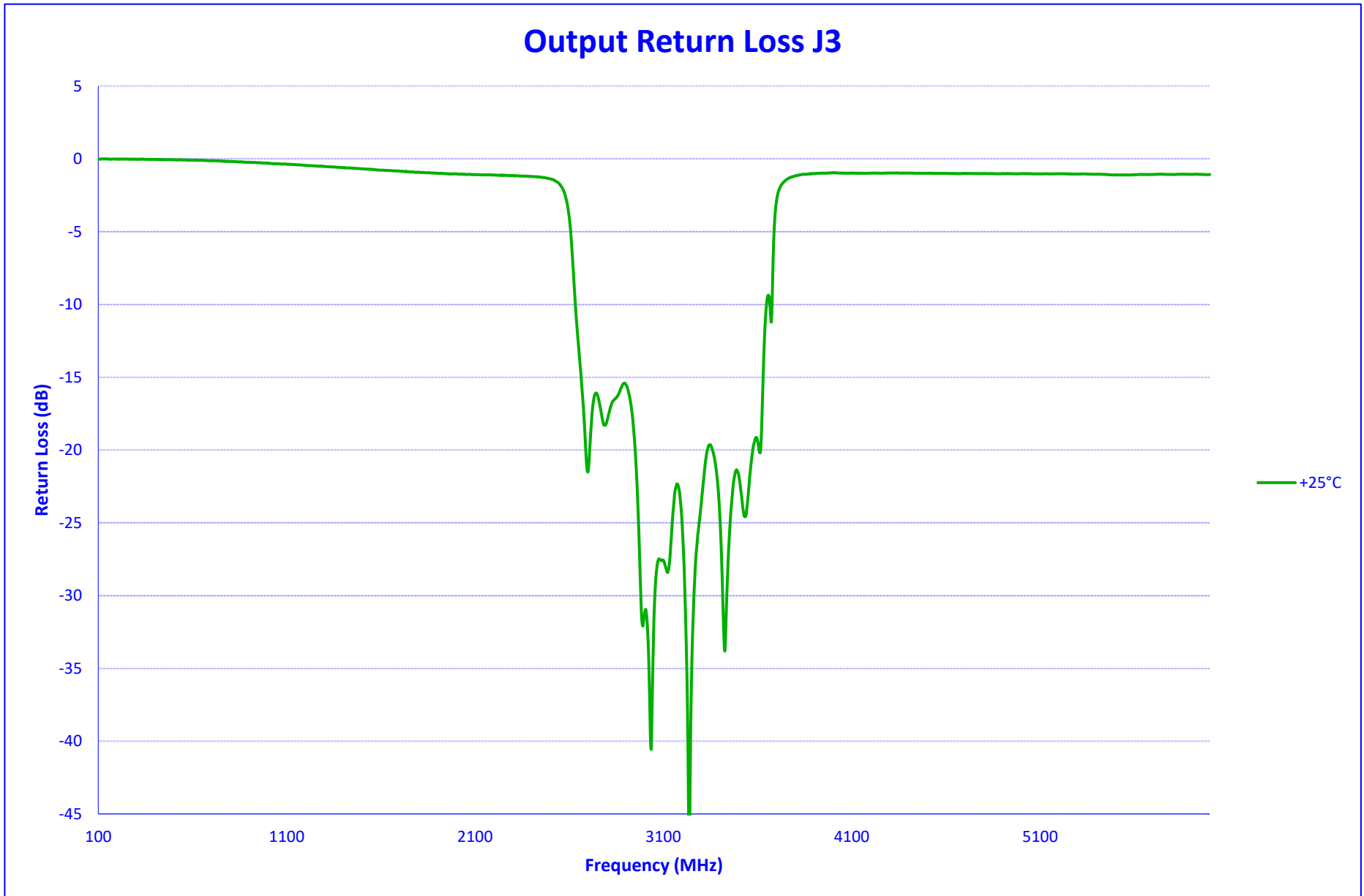



TYPICAL CHARACTERISTICS
ON
PRX-20-1G18G-850M-SFF-V2

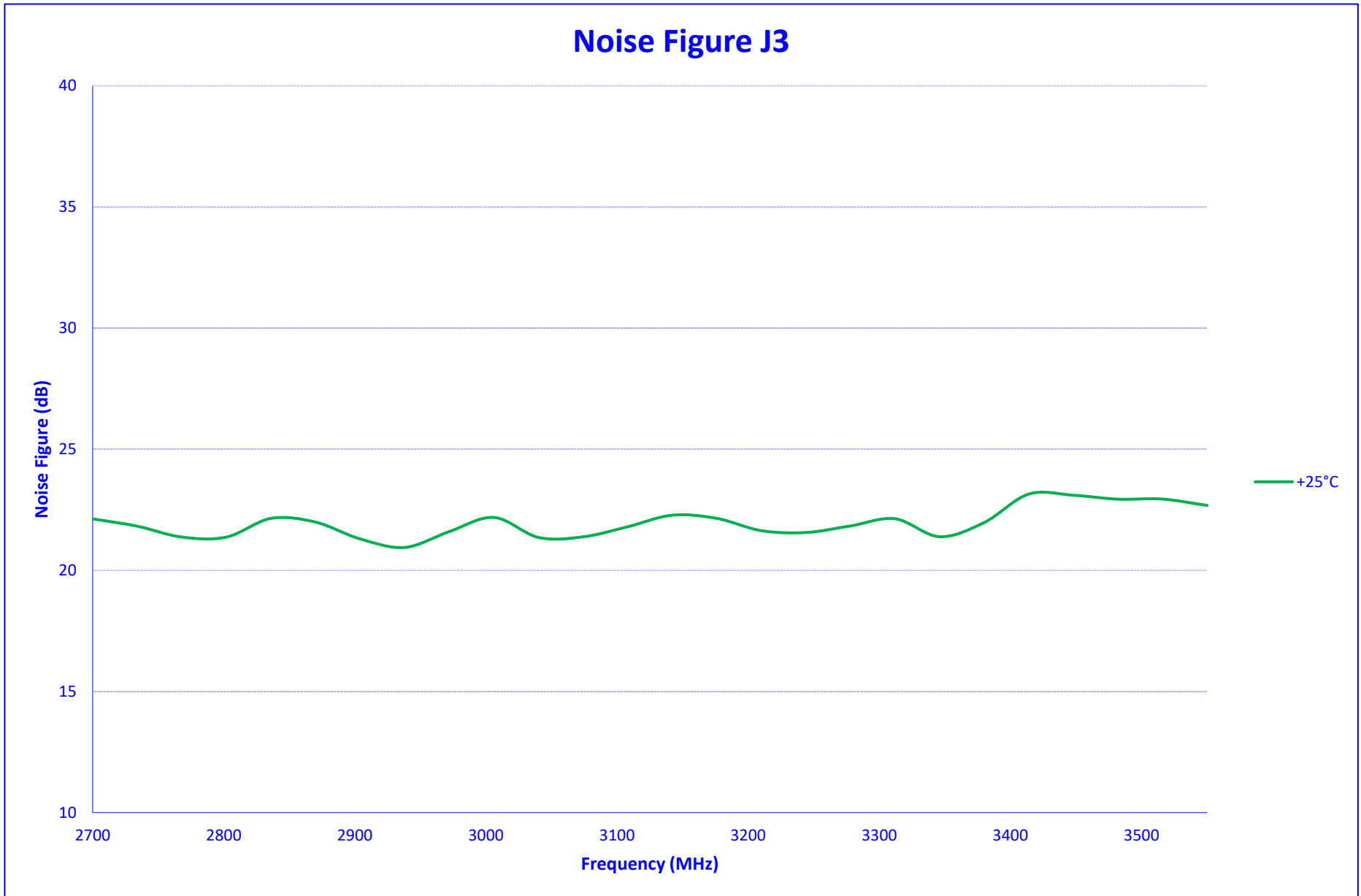



**TYPICAL CHARACTERISTICS
ON
PRX-20-1G18G-850M-SFF-V2**

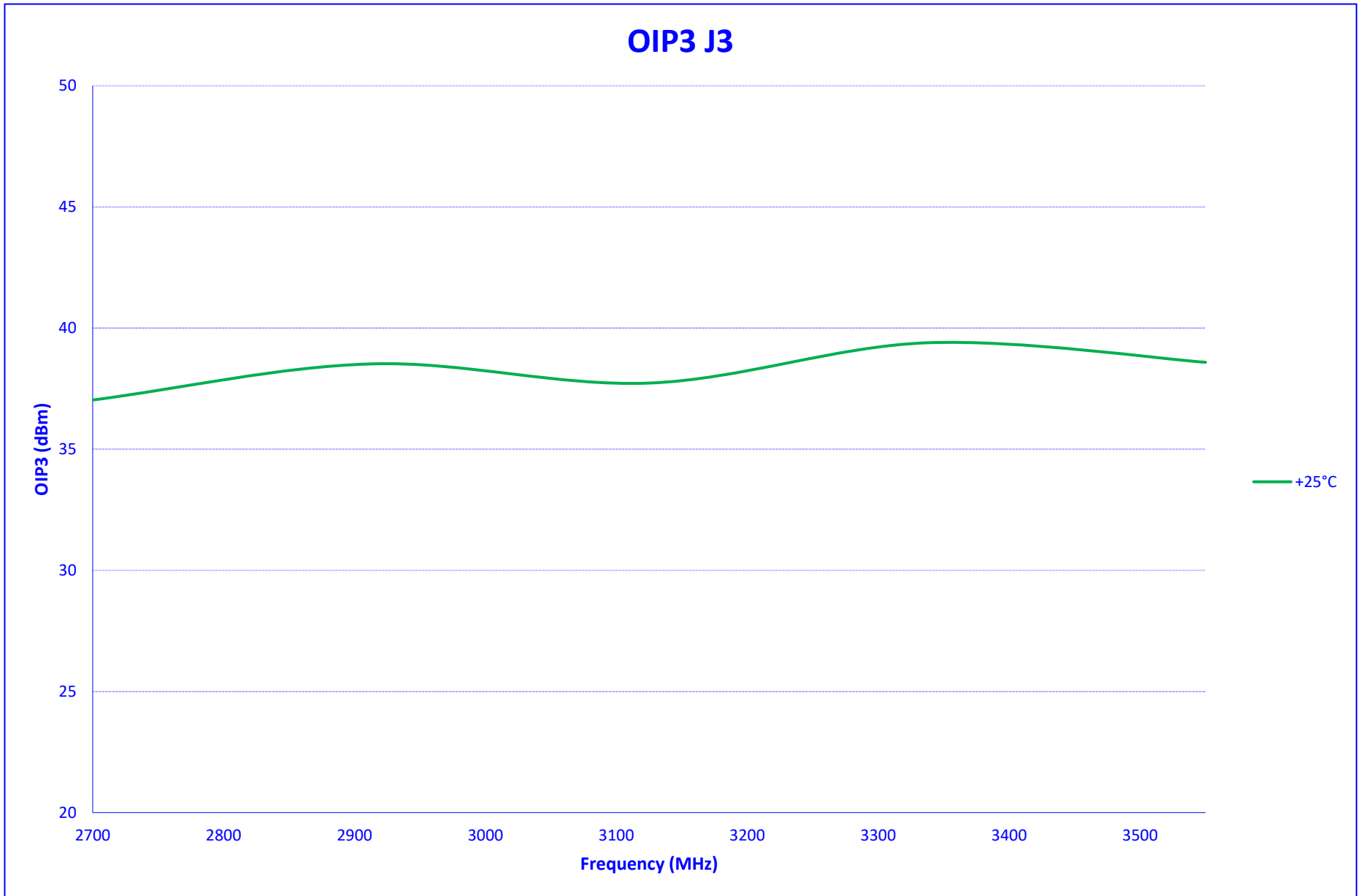



TYPICAL CHARACTERISTICS
ON
PRX-20-1G18G-850M-SFF-V2

IN BAND SPURS J3

25°C

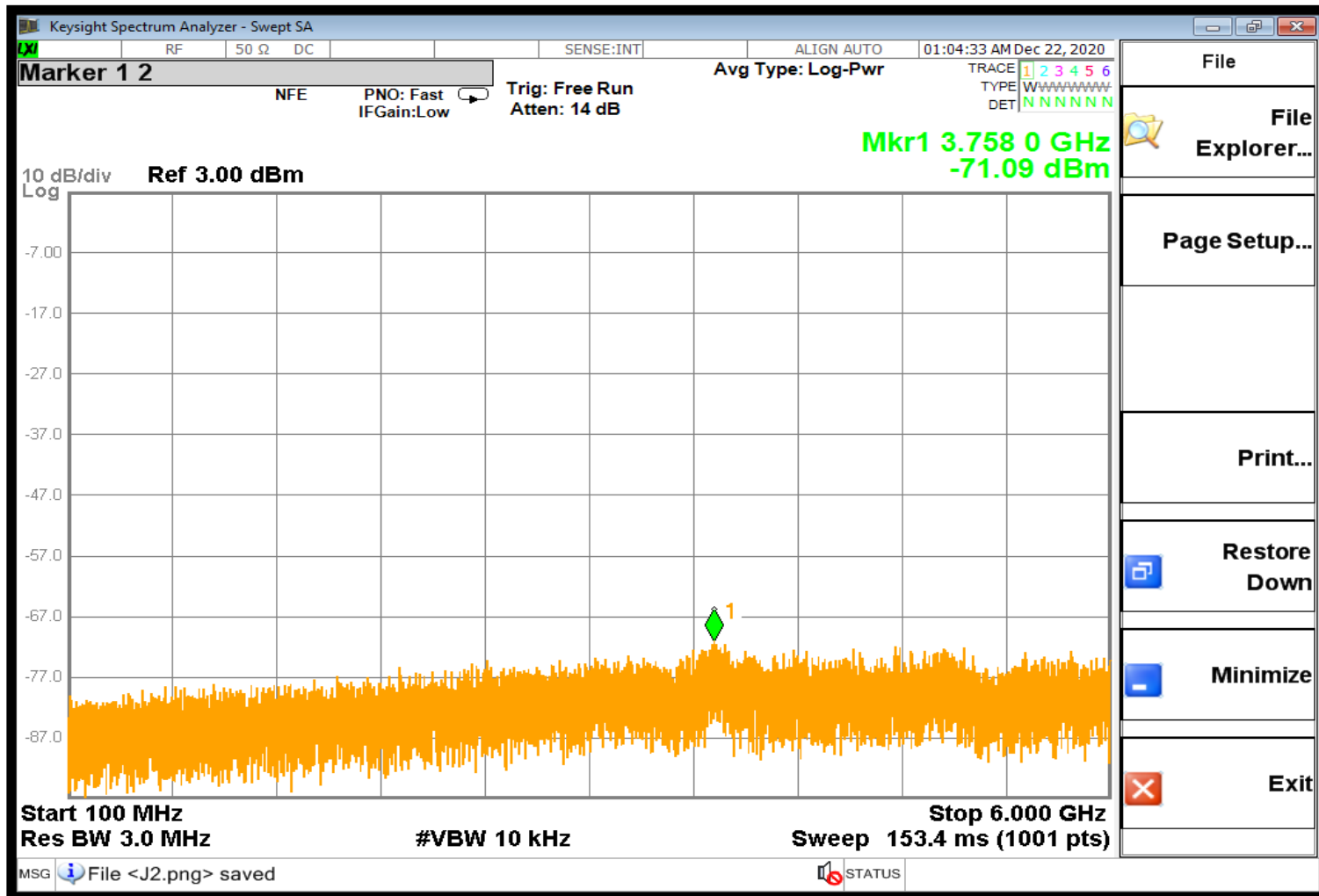



**TYPICAL CHARACTERISTICS
ON
PRX-20-1G18G-850M-SFF-V2**

SUMMARY DATA FOR J4

TEST NO	PARAMETERS	SPECIFIED VALUE	TEST RESULTS
Input Frequency: 3550 - 4400 MHz			+25°C
1	Frequency Range J4:	3550 MHz to 4400 MHz	3550 MHz to 4400 MHz
2	Power Input:	-60 to 0 dBm	-60 to 0 dBm
3	Gain J4:	0 dB ± 3 dB	-0.6 ± 1.6 dB
4	Noise Figure J4:	25 dB Typ	26.61 dB
5	Output IP3 J4:	30 dBm Typ	32.12 dBm
6	Output VSWR J4:	2 : 1 Max	1.4 : 1
7	Passband J4:	Lower 3540 MHz Typ	3522 MHz
		Upper 4410 MHz Typ	4414 MHz
		Passband 870 MHz Typ	892 MHz
8	Stopband J4:	Lower 3275MHz Typ	3415 MHz
		Upper 4675 MHz Typ	4566 MHz
		Stopband 1400 MHz Max	1151 MHz
9	Worst Case Spur: (Powered, No RF Input)	-60 dBm Typ	None
10	Inband Worst Case Spur: (1-18 GHz RF Input)	-60 dBm Typ	None



**TYPICAL CHARACTERISTICS
ON
PRX-20-1G18G-850M-SFF-V2**

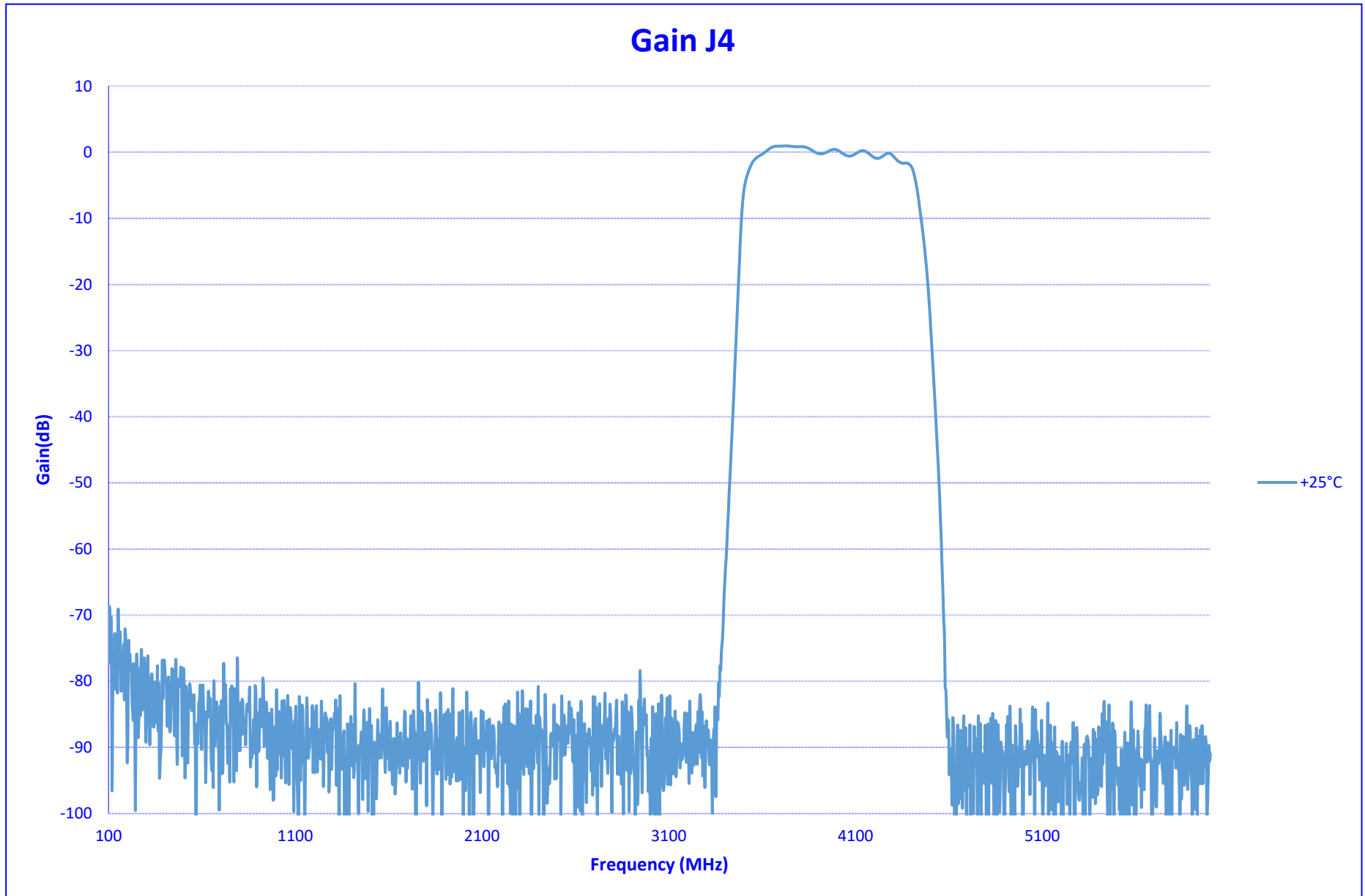



**TYPICAL CHARACTERISTICS
ON
PRX-20-1G18G-850M-SFF-V2**

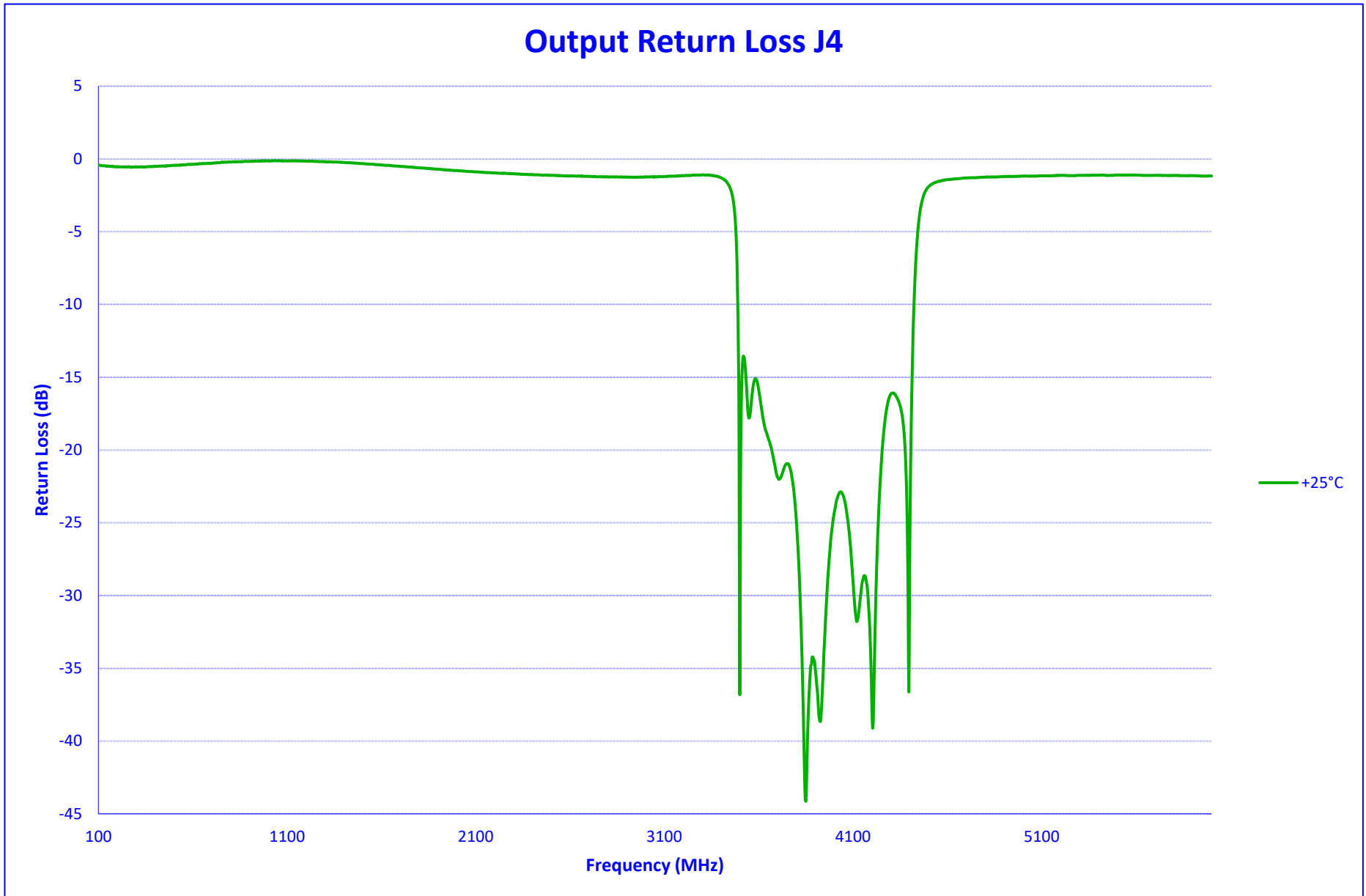



TYPICAL CHARACTERISTICS
ON
PRX-20-1G18G-850M-SFF-V2

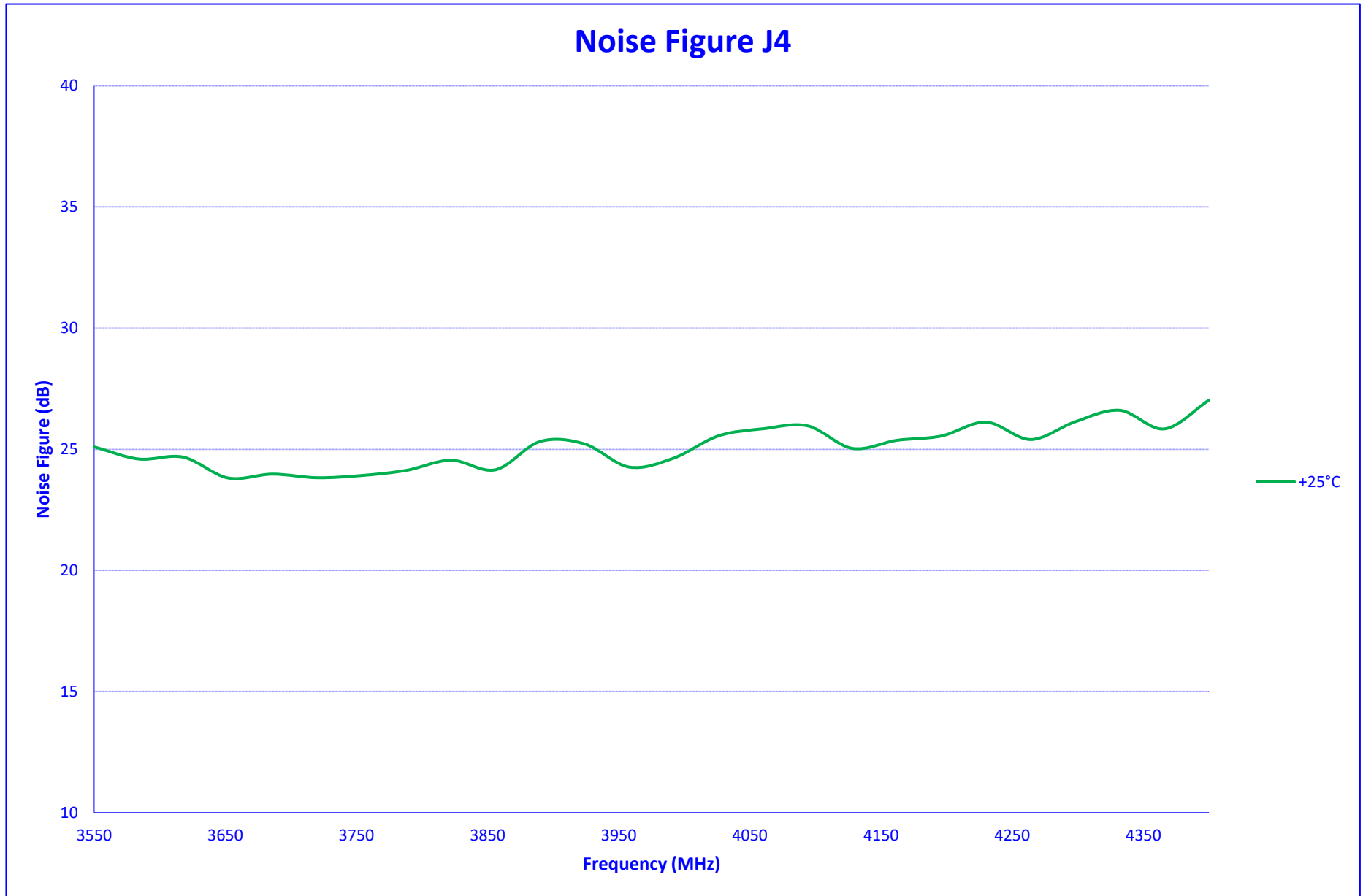



**TYPICAL CHARACTERISTICS
ON
PRX-20-1G18G-850M-SFF-V2**

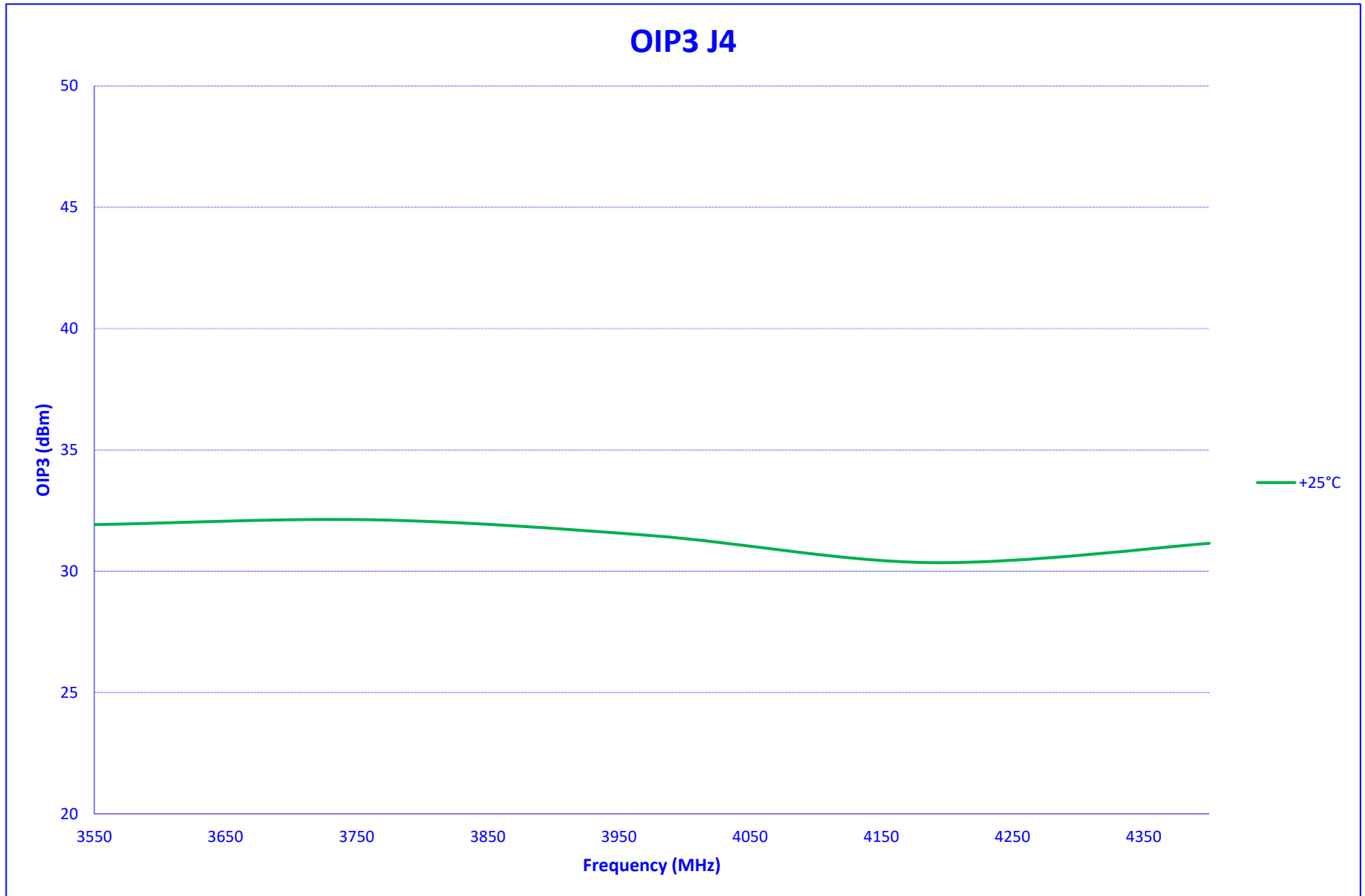



TYPICAL CHARACTERISTICS
ON
PRX-20-1G18G-850M-SFF-V2

IN BAND SPURS J4

25°C

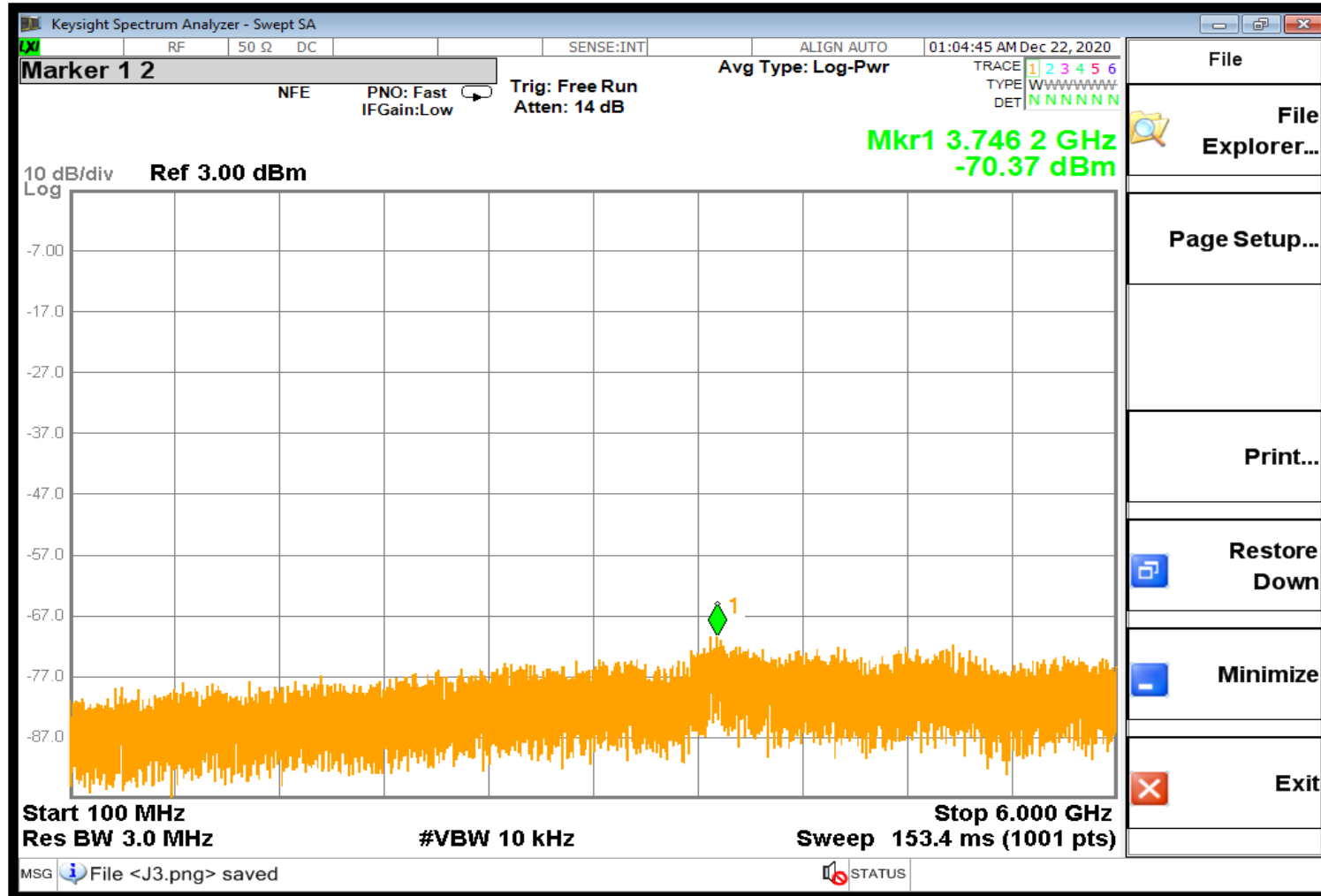



**TYPICAL CHARACTERISTICS
ON
PRX-20-1G18G-850M-SFF-V2**

SUMMARY DATA J5

TEST NO	PARAMETERS	SPECIFIED VALUE	TEST RESULTS
Input Frequency: 6950 - 7800 MHz			+25°C
1	Frequency Range J5:	1000 MHz to 1850 MHz	1000 MHz to 1850 MHz
2	Power Input:	-60 to 0 dBm	-60 to 0 dBm
3	Gain J5:	0 dB ± 3 dB	0.2 ± 2.4 dB
4	Noise Figure J5:	33 dB Typ	29.72 dB
5	Output IP3 J5:	30 dBm Typ	35.47 dBm
6	Output VSWR J5:	2 : 1 Max	1.5 : 1
7	Passband J5:	Lower 990 MHz Typ	985 MHz
		Upper 1860 MHz Typ	1866 MHz
		Passband 870 MHz Typ	881 MHz
8	Stopband J5:	Lower 890 MHz Typ	948 MHz
		Upper 1980 MHz Typ	1936 MHz
		Stopband 1400 MHz Max	988 MHz
9	Worst Case Spur: (Powered, No RF Input)	-60 dBm Typ	-60.39 dBm
10	Inband Worst Case Spur: (1-18 GHz RF Input)	-60 dBm Typ	-58.27 dBm



TYPICAL CHARACTERISTICS
ON
PRX-20-1G18G-850M-SFF-V2

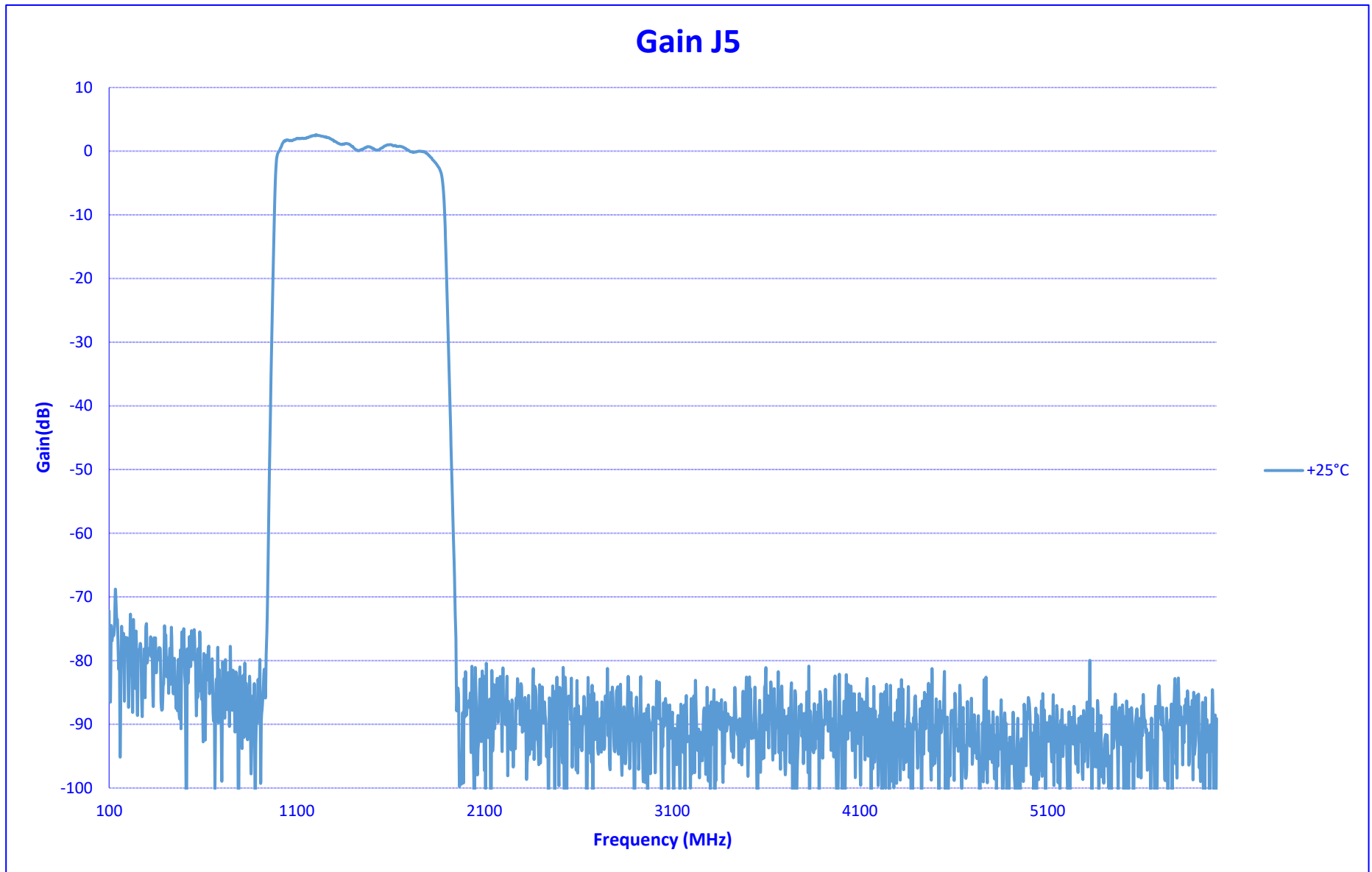



TYPICAL CHARACTERISTICS
ON
PRX-20-1G18G-850M-SFF-V2

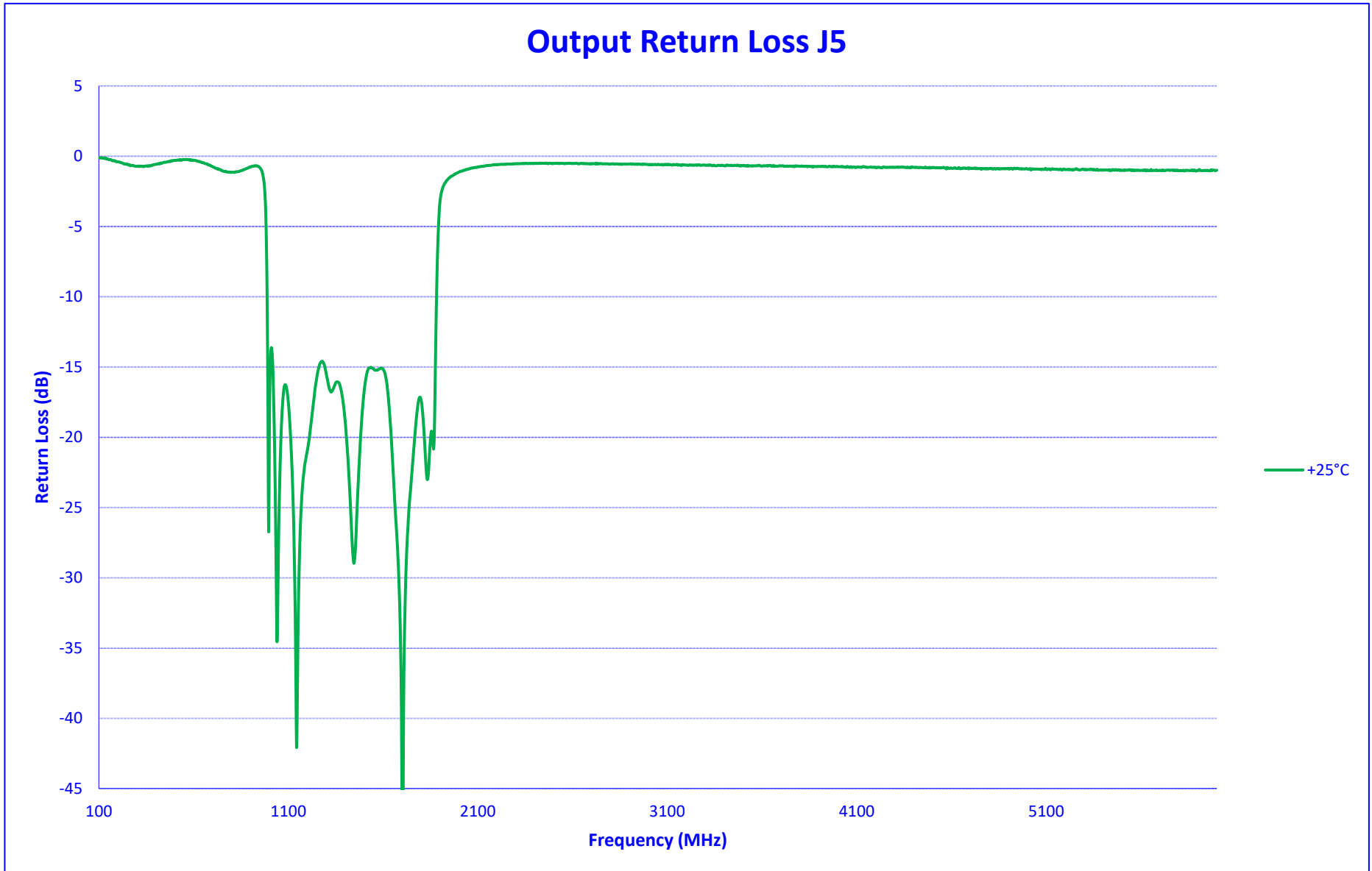



**TYPICAL CHARACTERISTICS
ON
PRX-20-1G18G-850M-SFF-V2**

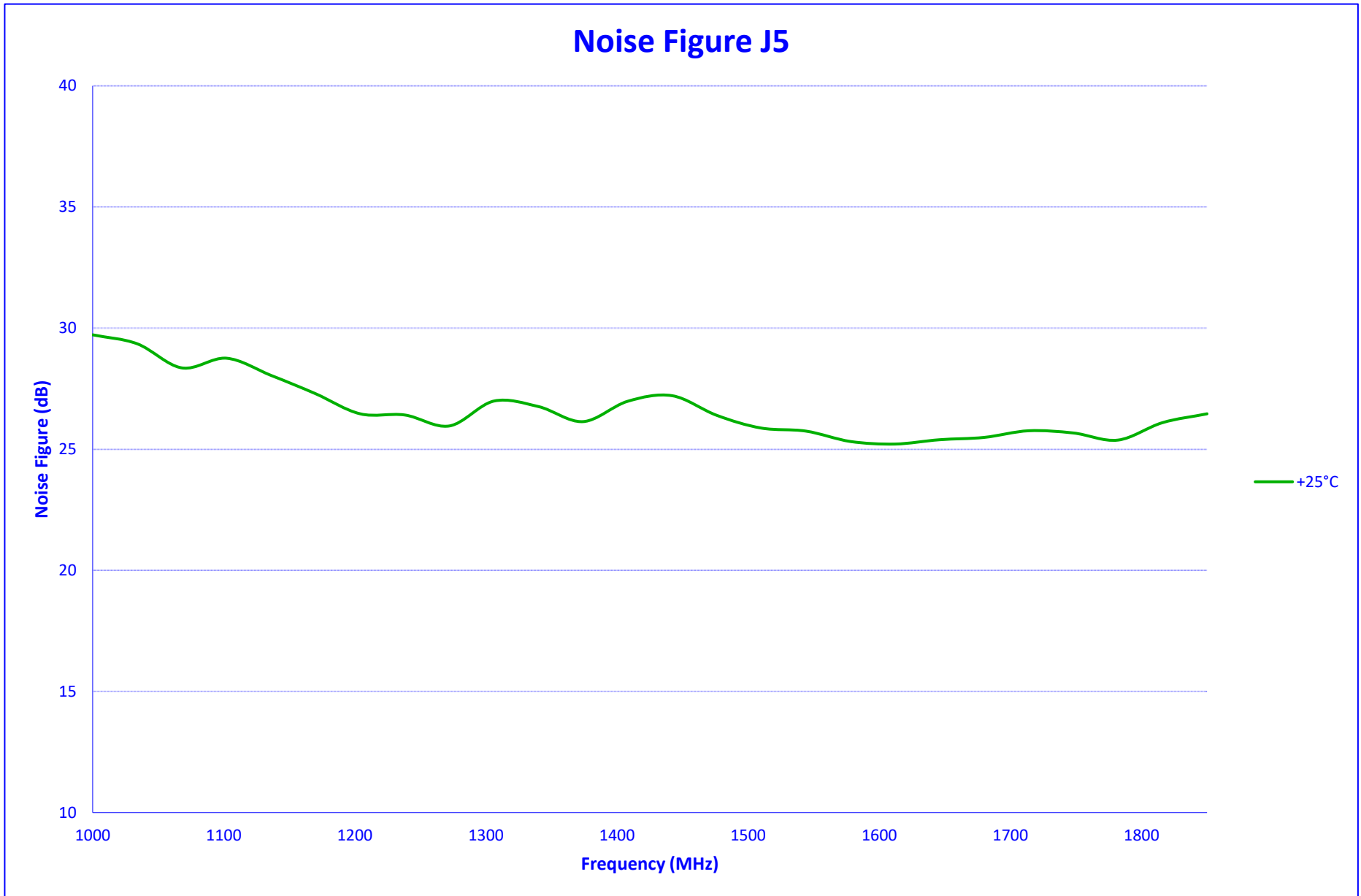



**TYPICAL CHARACTERISTICS
ON
PRX-20-1G18G-850M-SFF-V2**

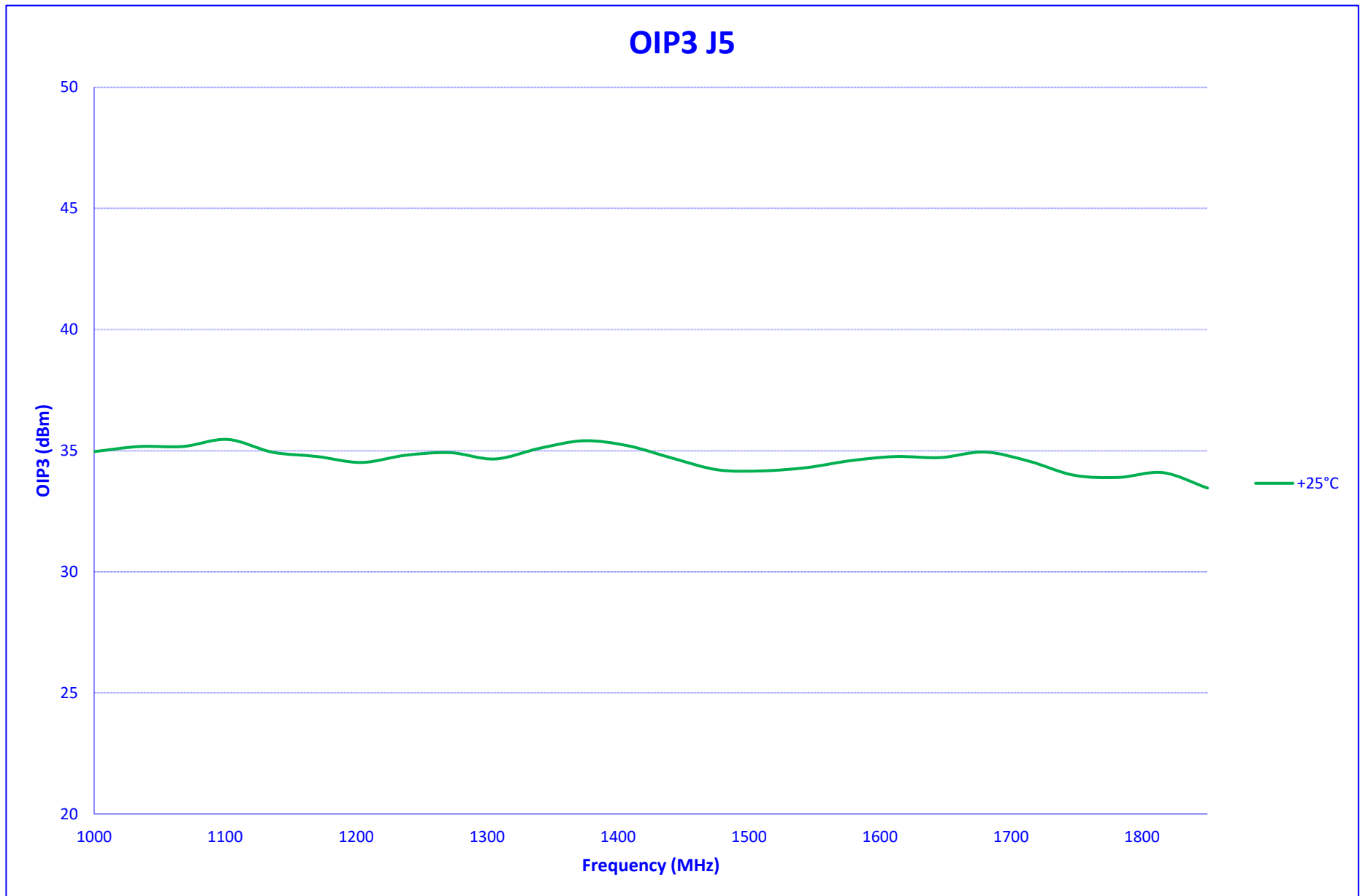



TYPICAL CHARACTERISTICS
ON
PRX-20-1G18G-850M-SFF-V2

IN BAND SPURS J5

25°C

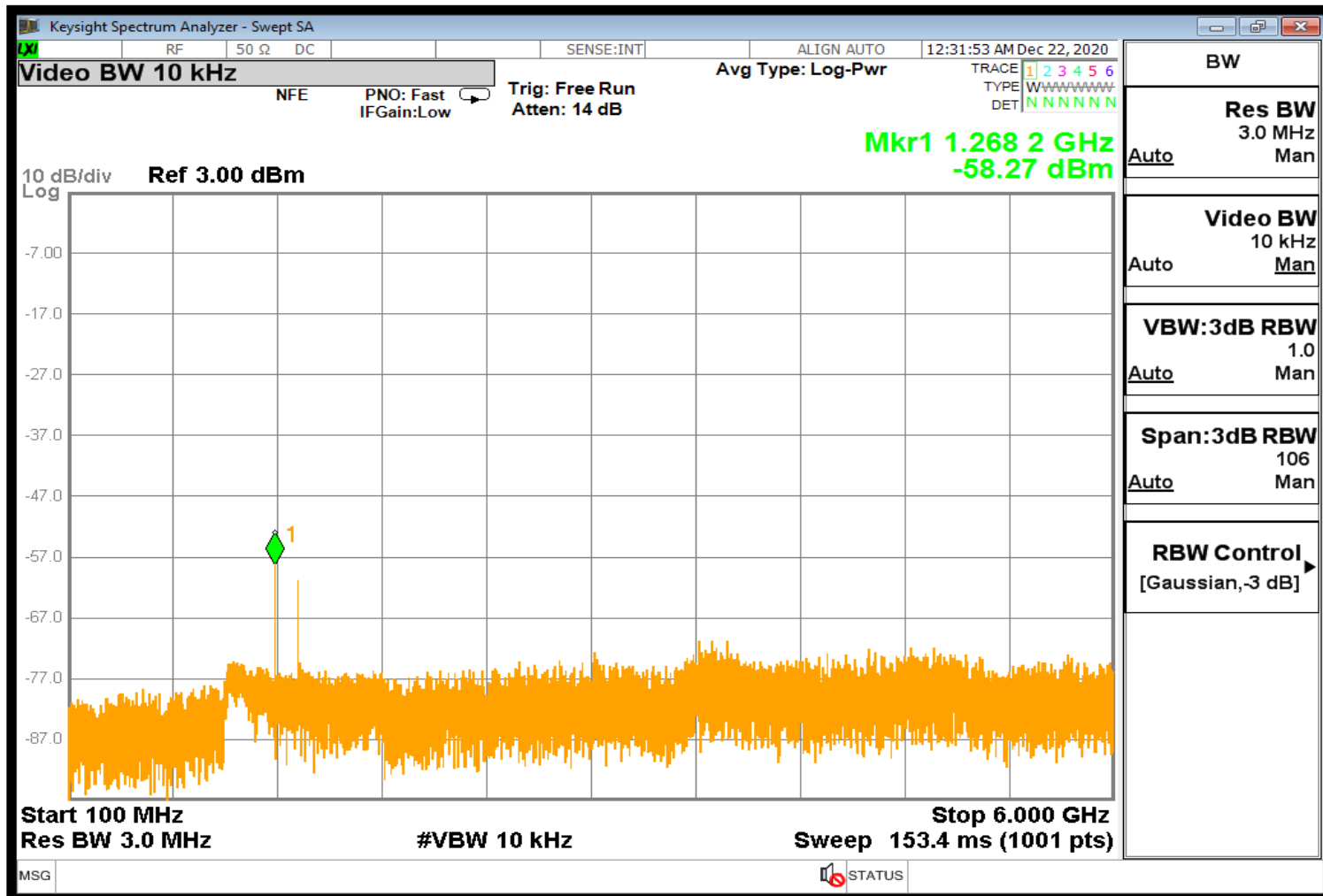



**TYPICAL CHARACTERISTICS
ON
PRX-20-1G18G-850M-SFF-V2**

SUMMARY DATA J6

TEST NO	PARAMETERS	SPECIFIED VALUE	TEST RESULTS
Input Frequency: 6100 - 6950 MHz			+25°C
1	Frequency Range J6:	1850 MHz to 2700 MHz	1850 MHz to 2700 MHz
2	Power Input:	-60 to 0 dBm	-60 to 0 dBm
3	Gain J6:	0 dB ± 3 dB	0.2 ± 0.9 dB
4	Noise Figure J6:	33 dB Typ	27.17 dB
5	Output IP3 J6:	30 dBm Typ	37.62 dBm
6	Output VSWR J6:	2 : 1 Max	1.3 : 1
7	Passband J6:	Lower 1840 MHz Typ	1822 MHz
		Upper 2710 MHz Typ	2729 MHz
		Passband 870 MHz Typ	907 MHz
8	Stopband J6:	Lower 1635 MHz Typ	1723 MHz
		Upper 2915 MHz Typ	2829 MHz
		Stopband 1400 MHz Max	1106 MHz
9	Worst Case Spur: (Powered, No RF Input)	-60 dBm Typ	-63.80 dBm
10	Inband Worst Case Spur: (1-18 GHz RF Input)	-60 dBm Typ	-59.64 dBm



**TYPICAL CHARACTERISTICS
ON
PRX-20-1G18G-850M-SFF-V2**

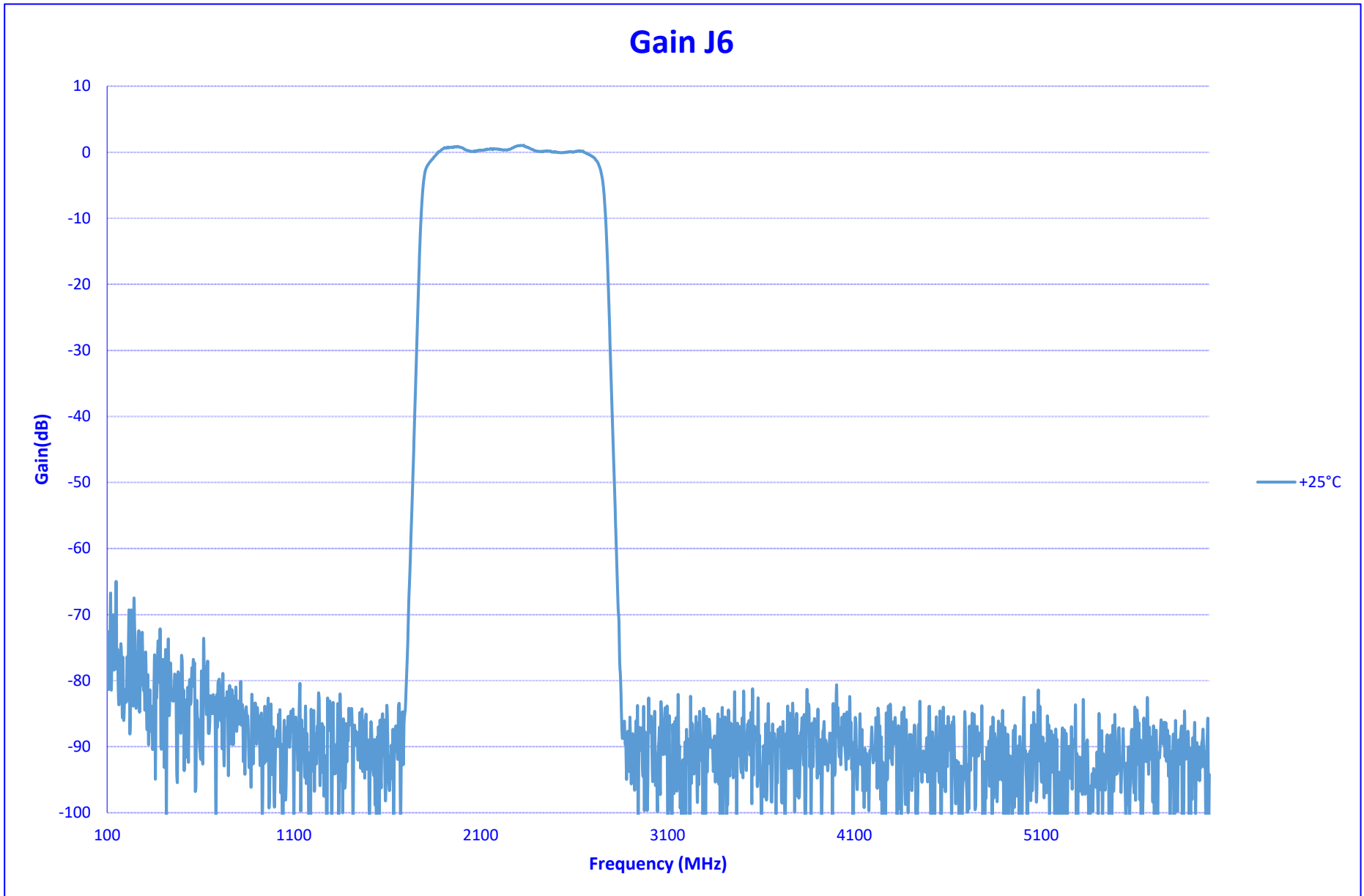



**TYPICAL CHARACTERISTICS
ON
PRX-20-1G18G-850M-SFF-V2**

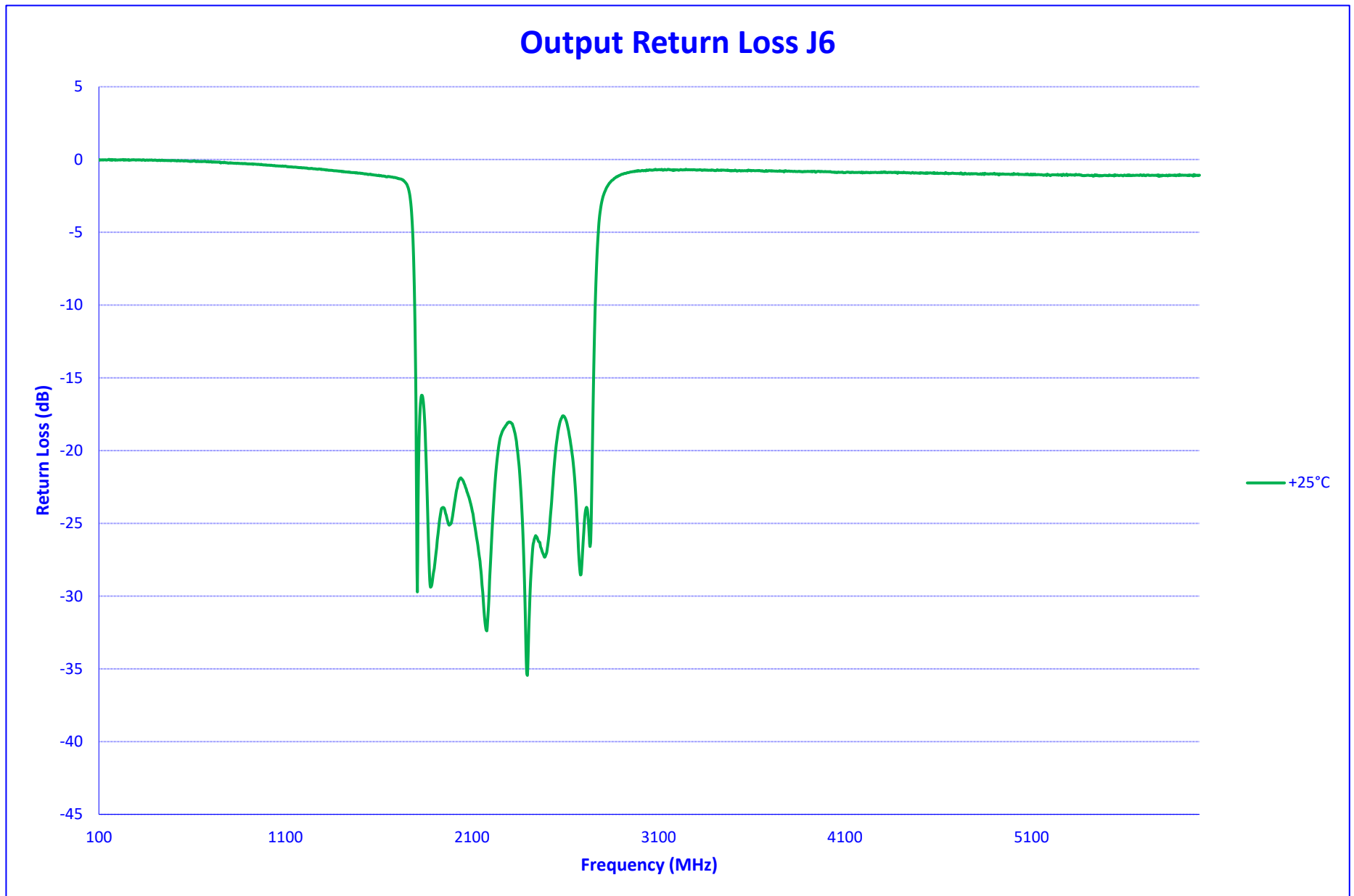



TYPICAL CHARACTERISTICS
ON
PRX-20-1G18G-850M-SFF-V2

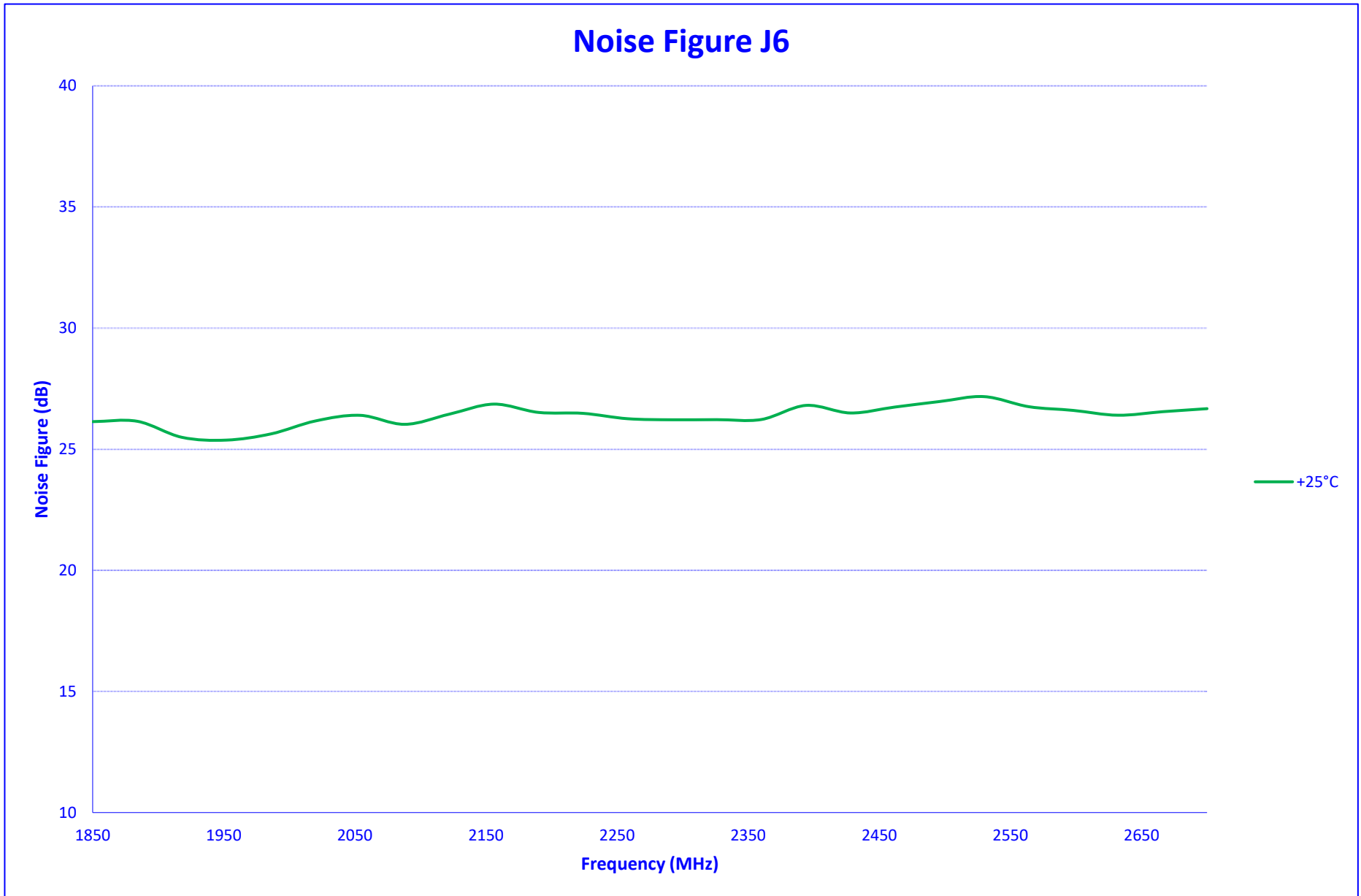



TYPICAL CHARACTERISTICS
ON
PRX-20-1G18G-850M-SFF-V2

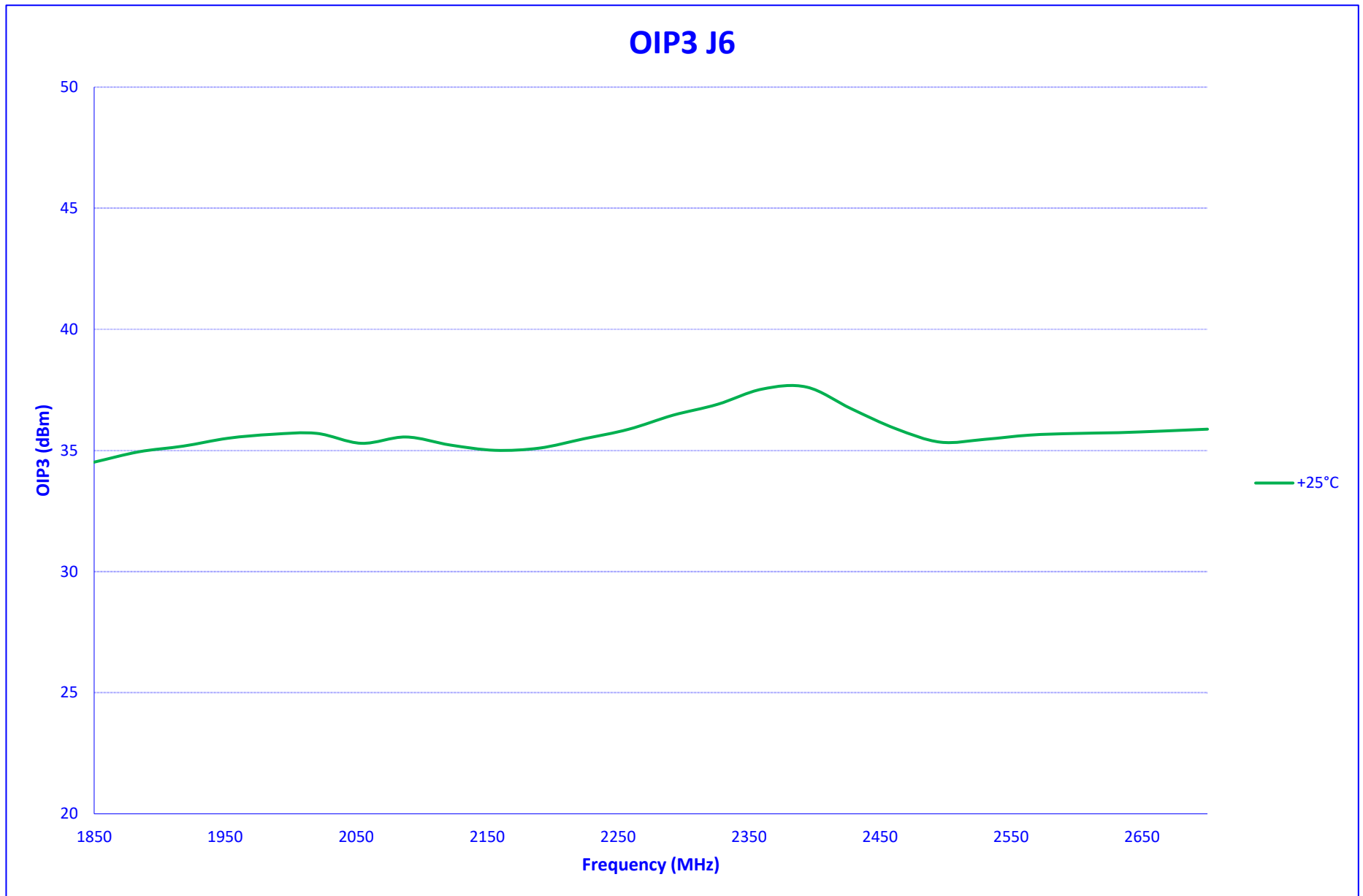



TYPICAL CHARACTERISTICS
ON
PRX-20-1G18G-850M-SFF-V2

IN BAND SPURS J6

25°C

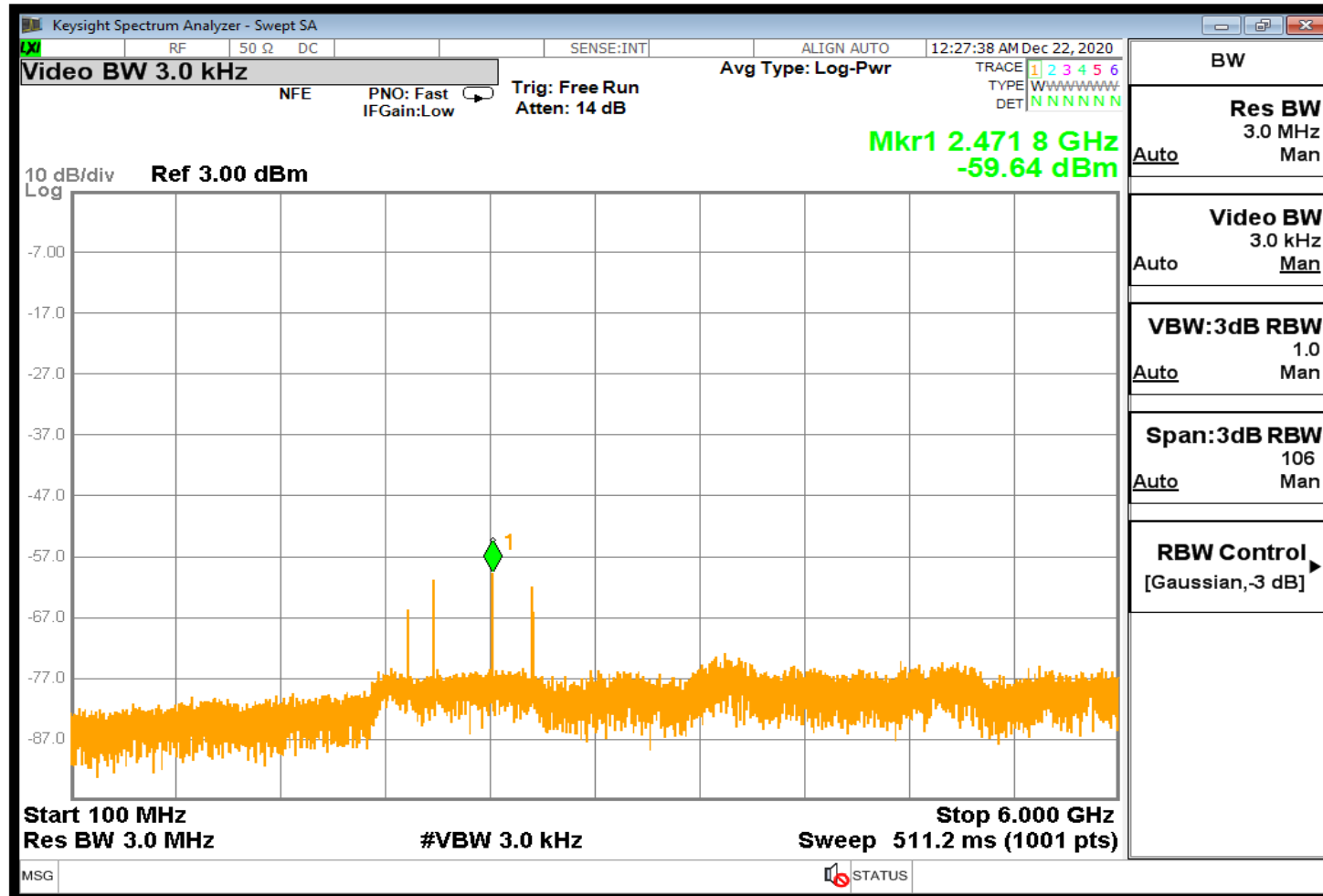



**TYPICAL CHARACTERISTICS
ON
PRX-20-1G18G-850M-SFF-V2**

SUMMARY DATA J7

TEST NO	PARAMETERS	SPECIFIED VALUE	TEST RESULTS
Input Frequency: 5250 - 6100 MHz			+25°C
1	Frequency Range J7:	2700 MHz to 3550 MHz	2700 MHz to 3550 MHz
2	Power Input:	-60 to 0 dBm	-60 to 0 dBm
3	Gain J7:	0 dB ± 3 dB	0.2 ± 1.6 dB
4	Noise Figure J7:	33 dB Typ	27.2 dB
5	Output IP3 J7:	30 dBm Typ	40.93 dBm
6	Output VSWR J7:	2 : 1 Max	1.5 : 1
7	Passband J7:	Lower 2690 MHz Typ	2667 MHz
		Upper 3560 MHz Typ	3585 MHz
		Passband 870 MHz Typ	918 MHz
8	Stopband J7:	Lower 2485 MHz Typ	2571 MHz
		Upper 3765 MHz Typ	3692 MHz
		Stopband 1400 MHz Max	1121 MHz
9	Worst Case Spur: (Powered, No RF Input)	-60 dBm Typ	-63.16 dBm
10	Inband Worst Case Spur: (1-18 GHz RF Input)	-60 dBm Typ	-60.98 dBm



**TYPICAL CHARACTERISTICS
ON
PRX-20-1G18G-850M-SFF-V2**

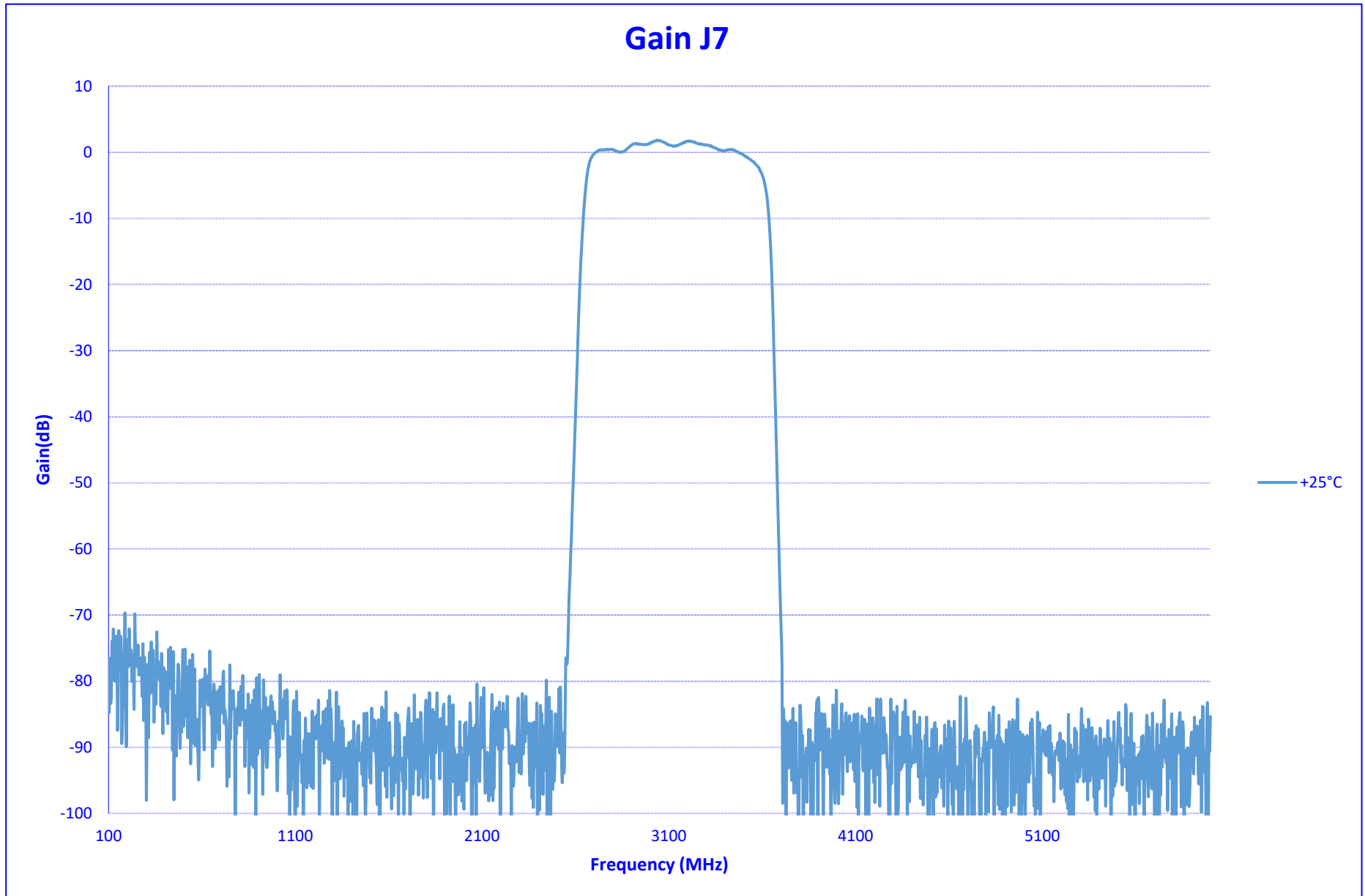



TYPICAL CHARACTERISTICS
ON
PRX-20-1G18G-850M-SFF-V2

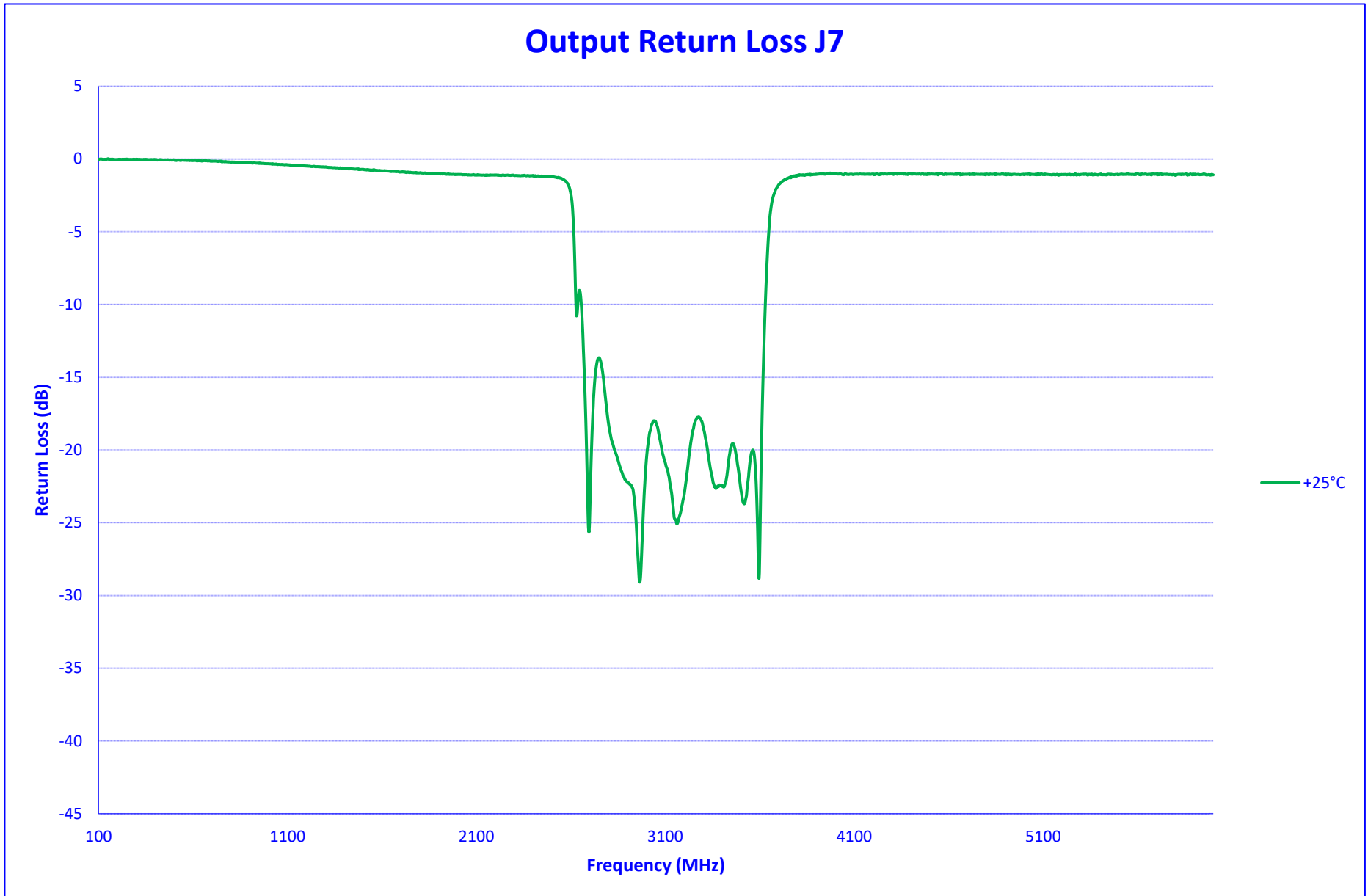



**TYPICAL CHARACTERISTICS
ON
PRX-20-1G18G-850M-SFF-V2**

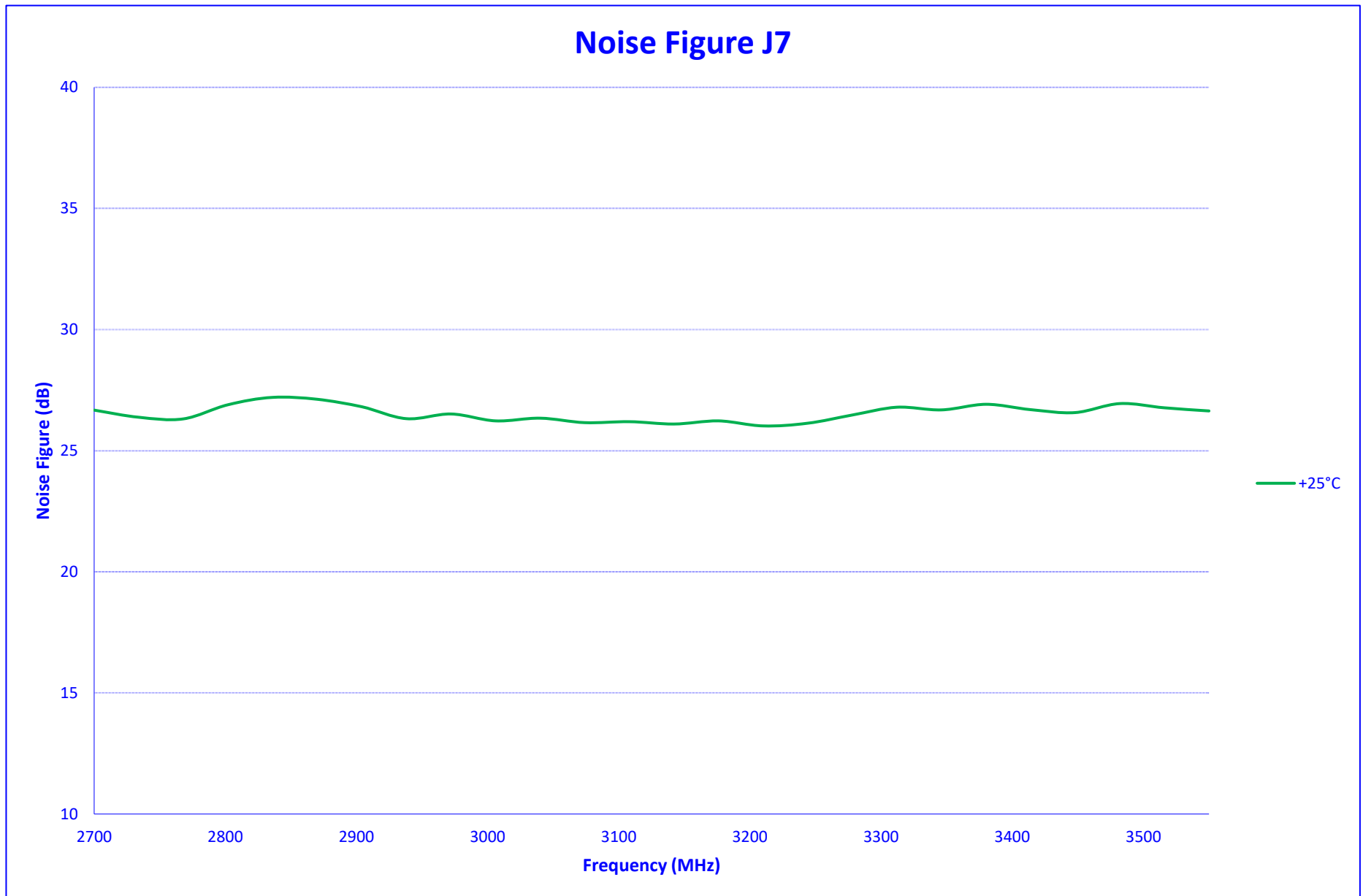



**TYPICAL CHARACTERISTICS
ON
PRX-20-1G18G-850M-SFF-V2**

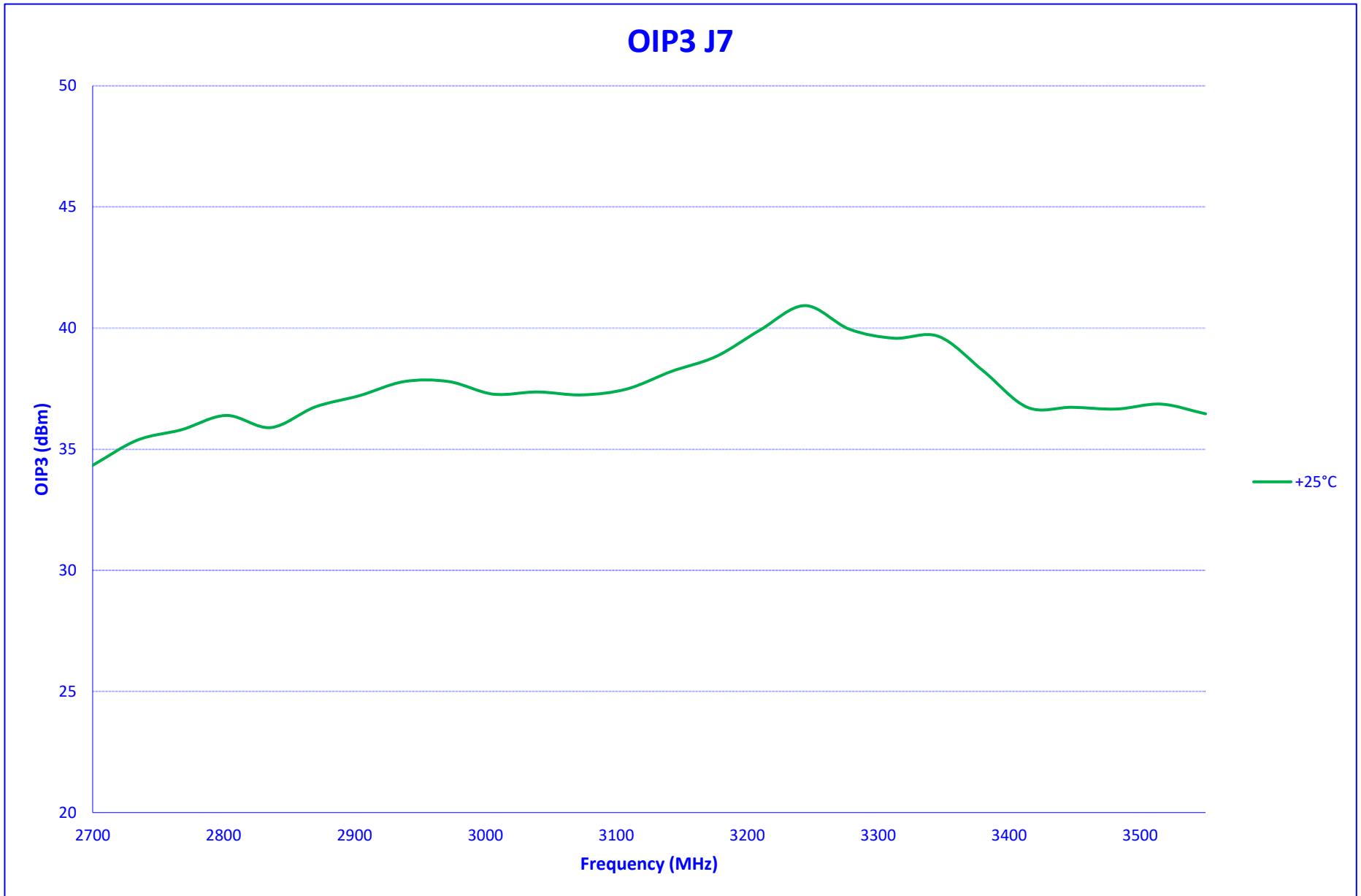



TYPICAL CHARACTERISTICS
ON
PRX-20-1G18G-850M-SFF-V2

IN BAND SPURS J7

25°C

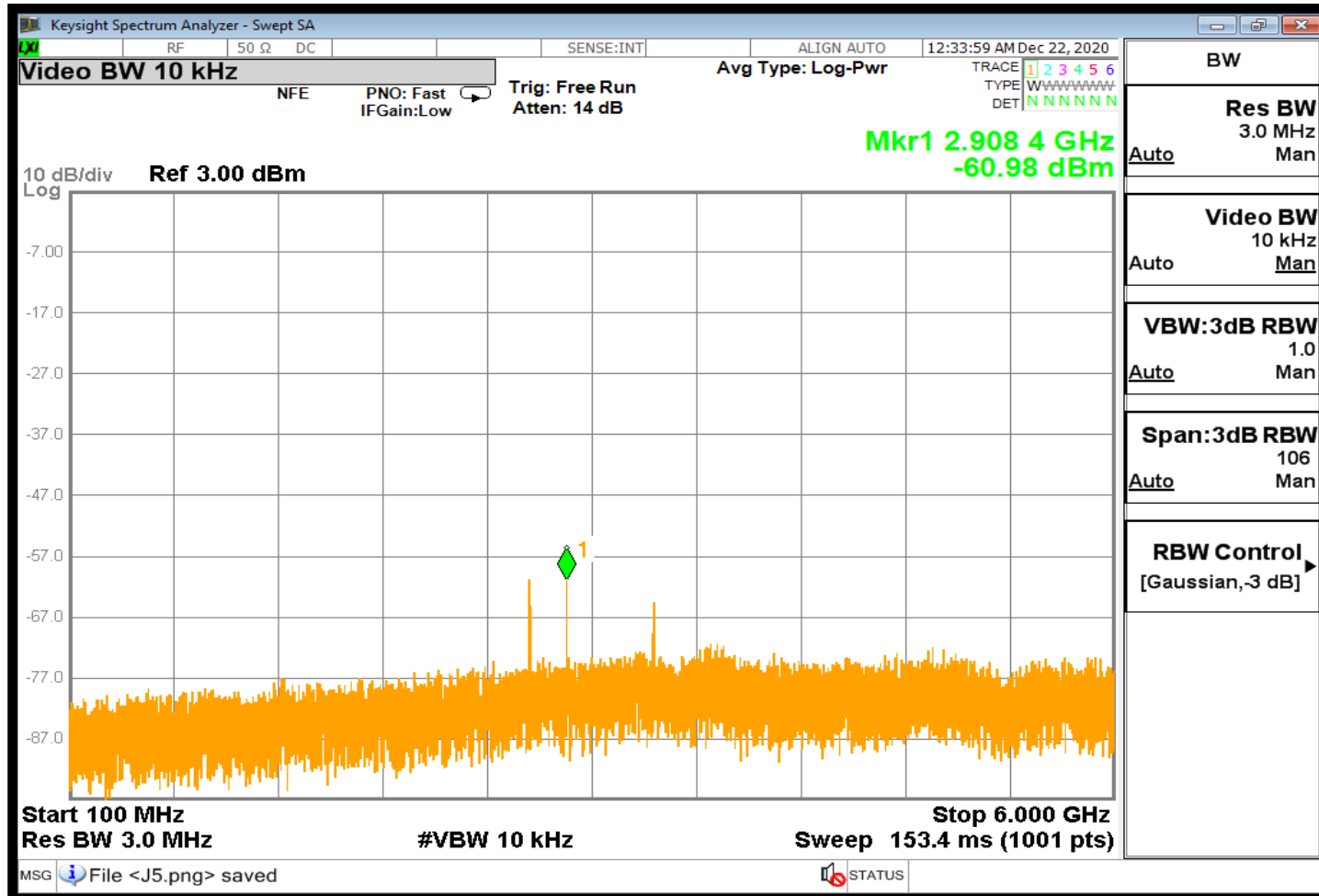



**TYPICAL CHARACTERISTICS
ON
PRX-20-1G18G-850M-SFF-V2**

SUMMARY DATA J8

TEST NO	PARAMETERS	SPECIFIED VALUE	TEST RESULTS
Input Frequency: 4400 - 5250 MHz			+25°C
1	Frequency Range J8:	3550 MHz to 4400 MHz	3550 MHz to 4400 MHz
2	Power Input:	-60 to 0 dBm	-60 to 0 dBm
3	Gain J8:	0 dB ± 3 dB	0 ± 1.9 dB
4	Noise Figure J8:	33 dB Typ	28.73 dB
5	Output IP3 J8:	30 dBm Typ	31.76 dBm
6	Output VSWR J8:	2 : 1 Max	1.7 : 1
7	Passband J8:	Lower 3540 MHz Typ	3500 MHz
		Upper 4410 MHz Typ	4422 MHz
		Passband 870 MHz Typ	922 MHz
8	Stopband J8:	Lower 3275MHz Typ	3415 MHz
		Upper 4675 MHz Typ	4507 MHz
		Stopband 1400 MHz Max	1092 MHz
9	Worst Case Spur: (Powered, No RF Input)	-60 dBm Typ	None
10	Inband Worst Case Spur: (1-18 GHz RF Input)	-60 dBm Typ	-57.34 dBm



**TYPICAL CHARACTERISTICS
ON
PRX-20-1G18G-850M-SFF-V2**

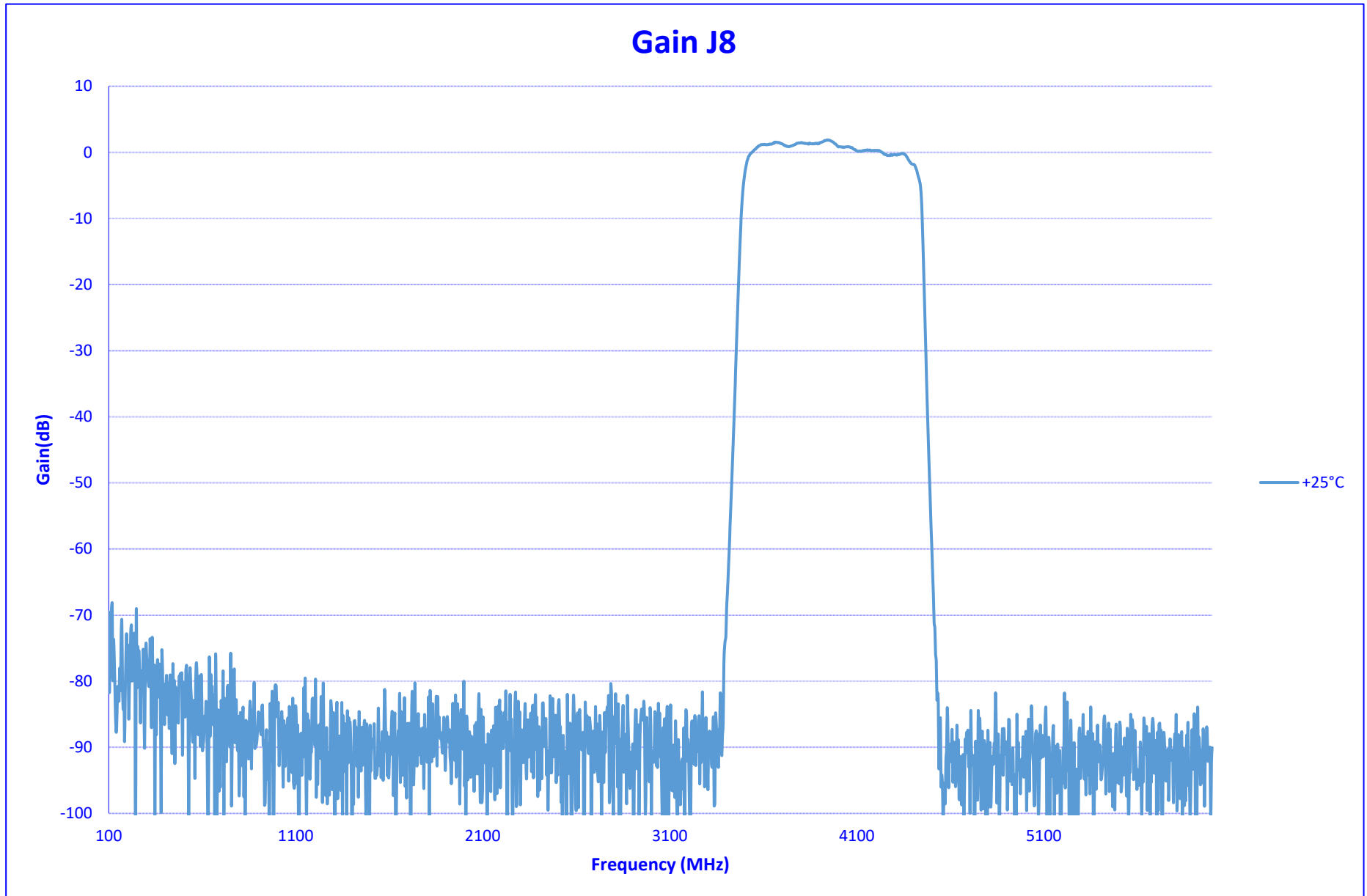



**TYPICAL CHARACTERISTICS
ON
PRX-20-1G18G-850M-SFF-V2**

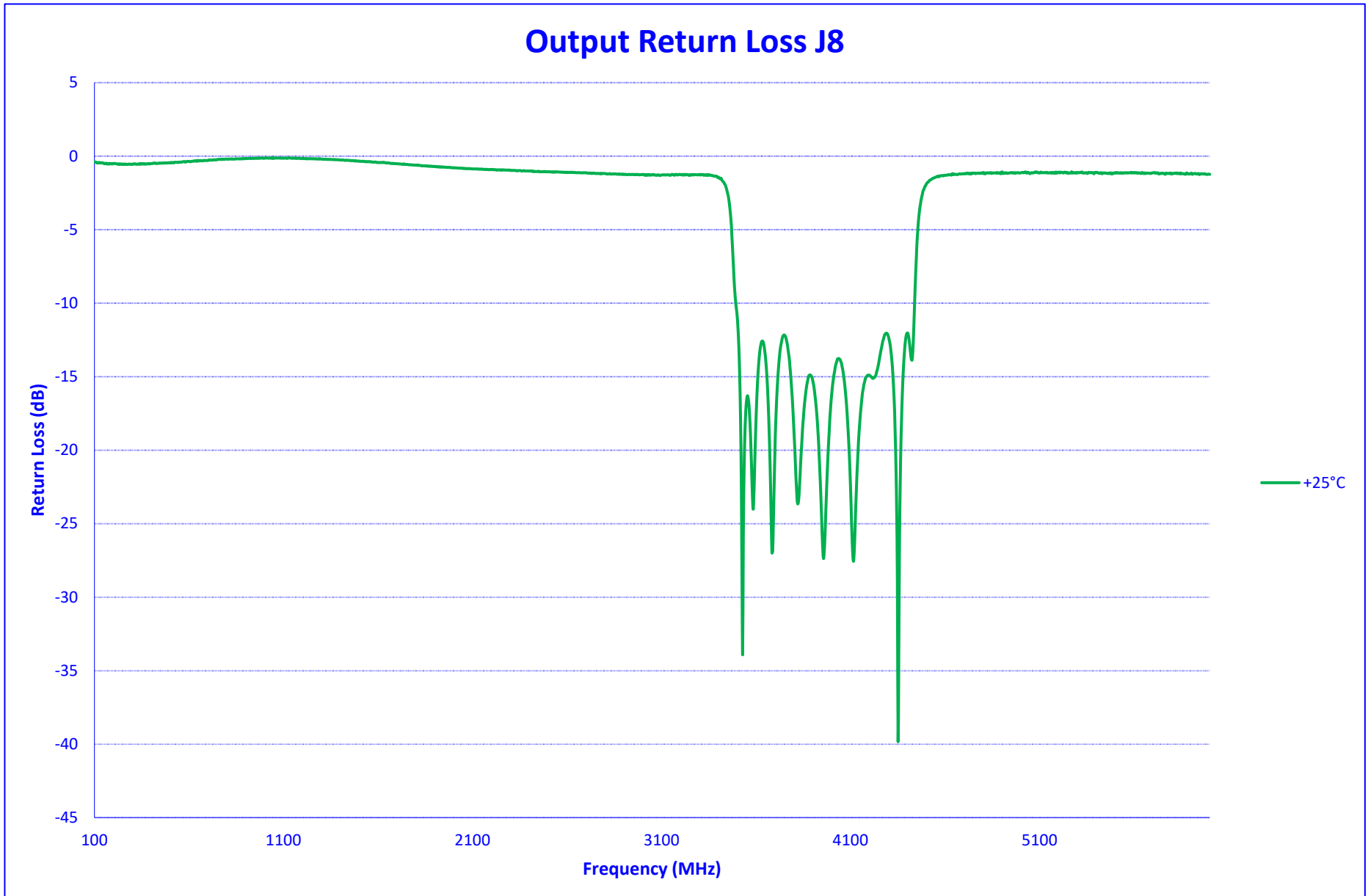



**TYPICAL CHARACTERISTICS
ON
PRX-20-1G18G-850M-SFF-V2**

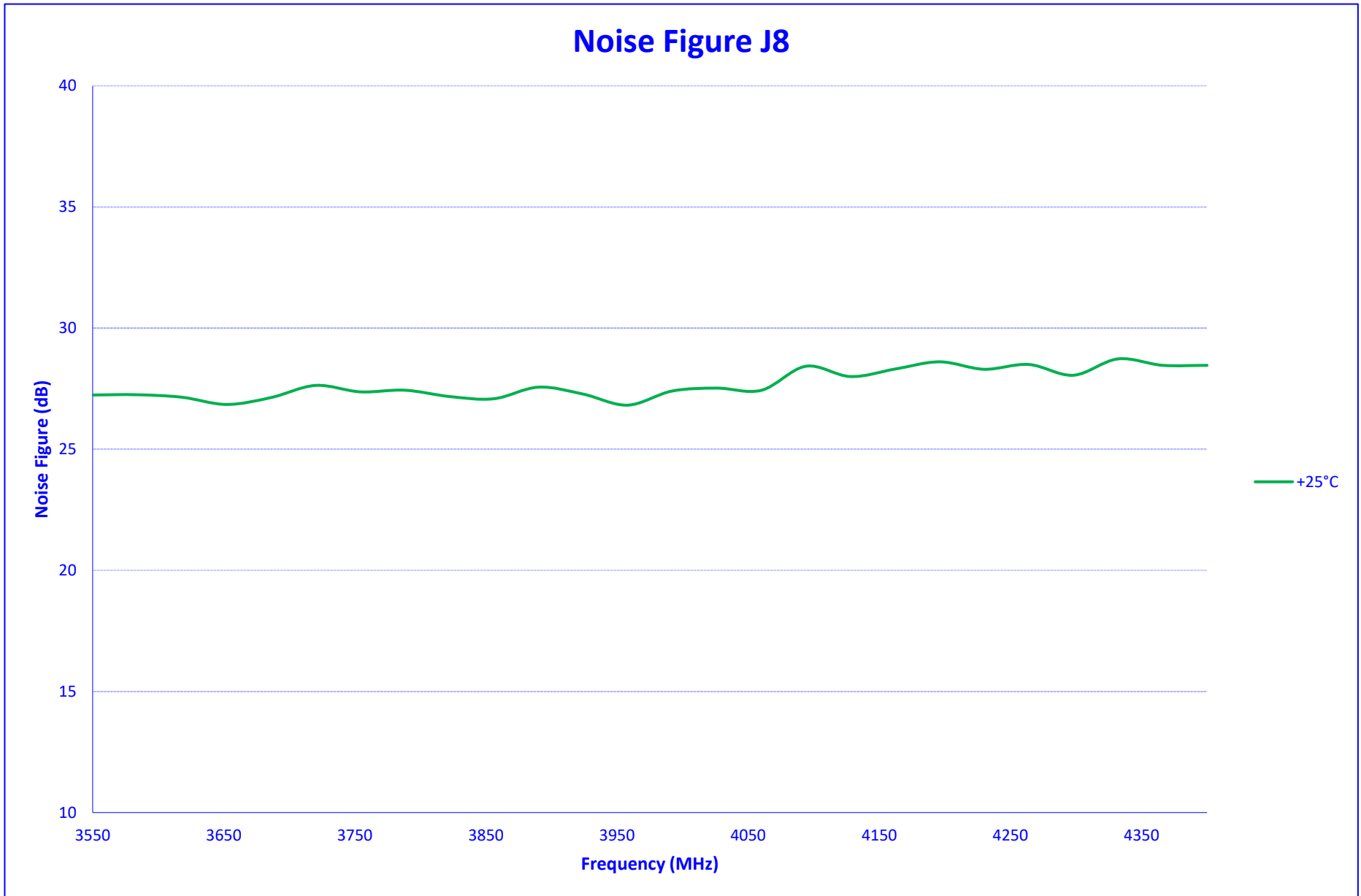



**TYPICAL CHARACTERISTICS
ON
PRX-20-1G18G-850M-SFF-V2**

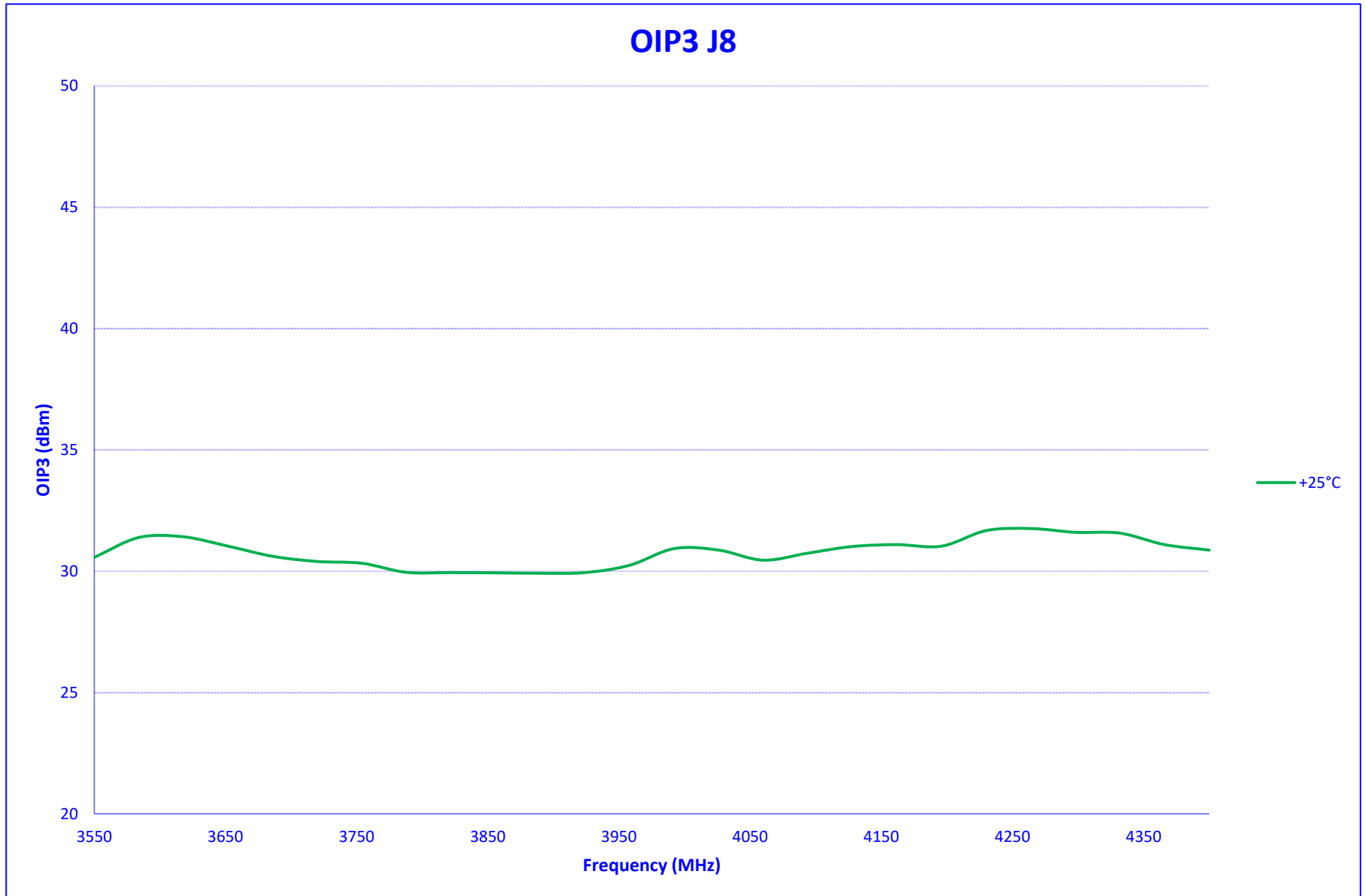



TYPICAL CHARACTERISTICS
ON
PRX-20-1G18G-850M-SFF-V2

IN BAND SPURS J8

25°C

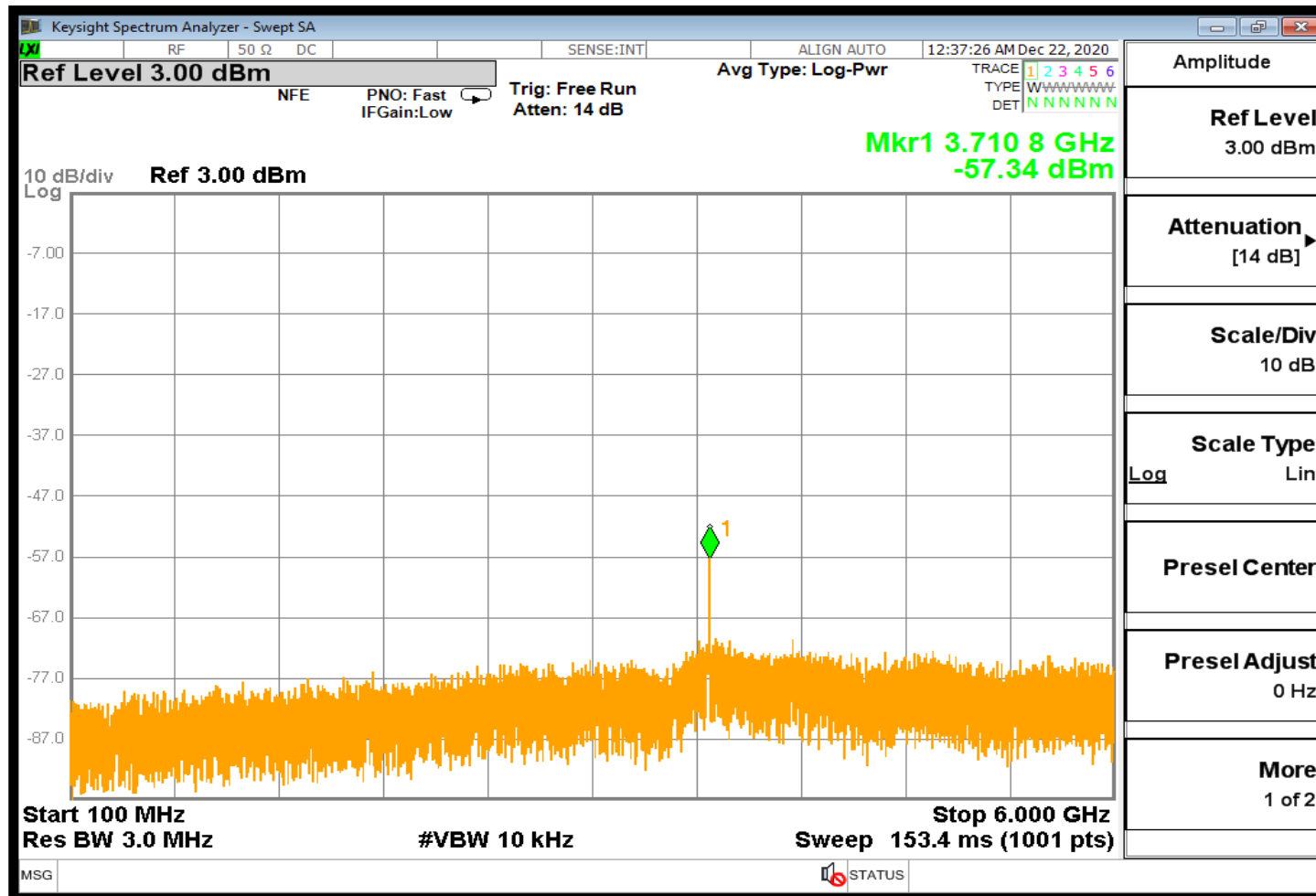



**TYPICAL CHARACTERISTICS
ON
PRX-20-1G18G-850M-SFF-V2**

SUMMARY DATA J9

TEST NO	PARAMETERS	SPECIFIED VALUE	TEST RESULTS
Input Frequency: 10350 - 11200 MHz			+25°C
1	Frequency Range J9:	1000 MHz to 1850 MHz	1000 MHz to 1850 MHz
2	Power Input:	-60 to 0 dBm	-60 to 0 dBm
3	Gain J9:	0 dB ± 3 dB	-0.2 ± 1.7 dB
4	Noise Figure J9:	35 dB Typ	28.04 dB
5	Output IP3 J9:	30 dBm Typ	37.21 dBm
6	Output VSWR J9:	2 : 1 Max	1.7 : 1
7	Passband J9:	Lower 990 MHz Typ	981 MHz
		Upper 1860 MHz Typ	1866 MHz
		Passband 870 MHz Typ	885 MHz
8	Stopband J9:	Lower 890 MHz Typ	933 MHz
		Upper 1980 MHz Typ	1936 MHz
		Stopband 1400 MHz Max	1003 MHz
9	Worst Case Spur: (Powered, No RF Input)	-60 dBm Typ	None
10	Inband Worst Case Spur: (1-18 GHz RF Input)	-60 dBm Typ	-70.8 dBm



**TYPICAL CHARACTERISTICS
ON
PRX-20-1G18G-850M-SFF-V2**

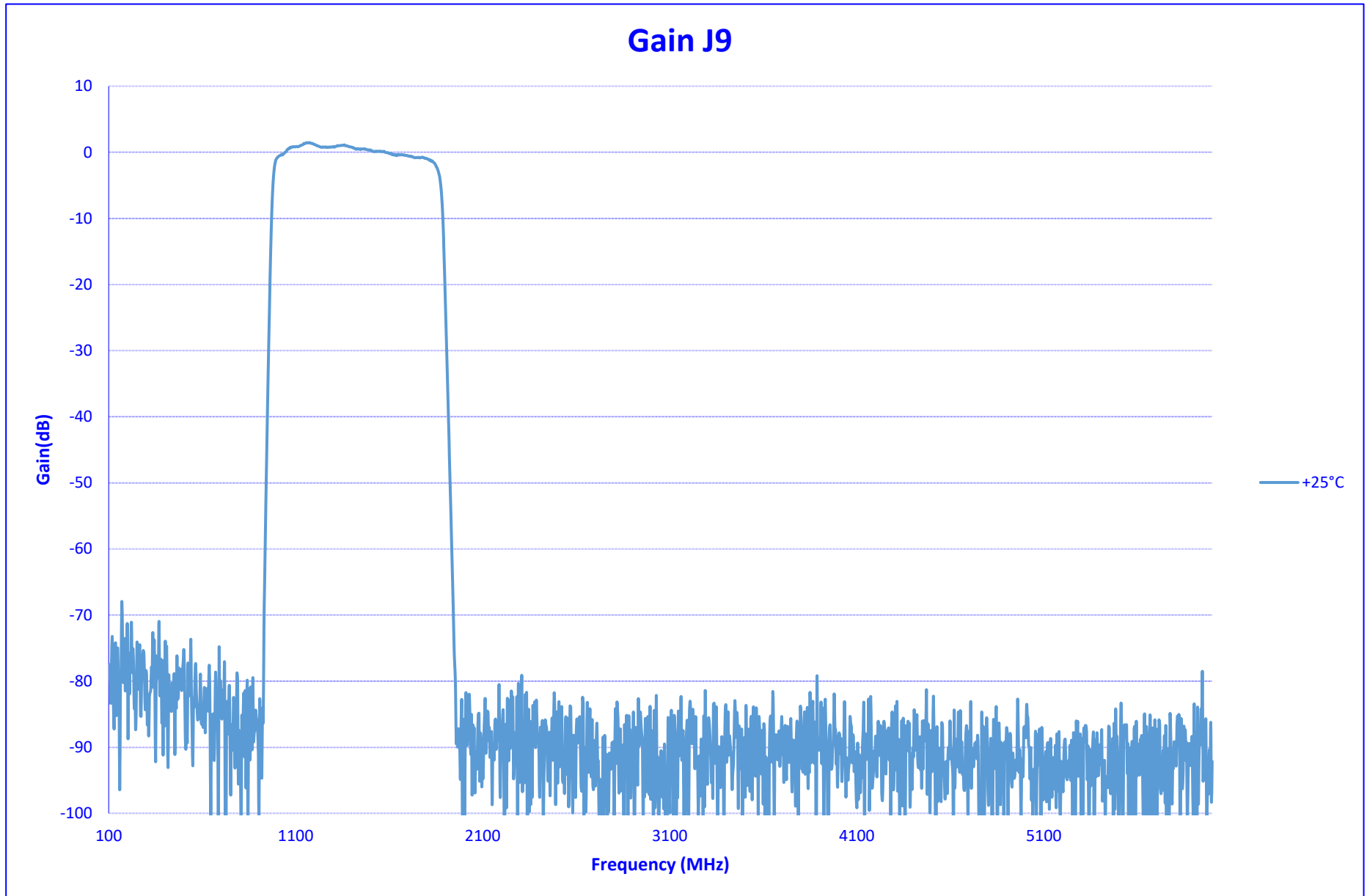



TYPICAL CHARACTERISTICS
ON
PRX-20-1G18G-850M-SFF-V2

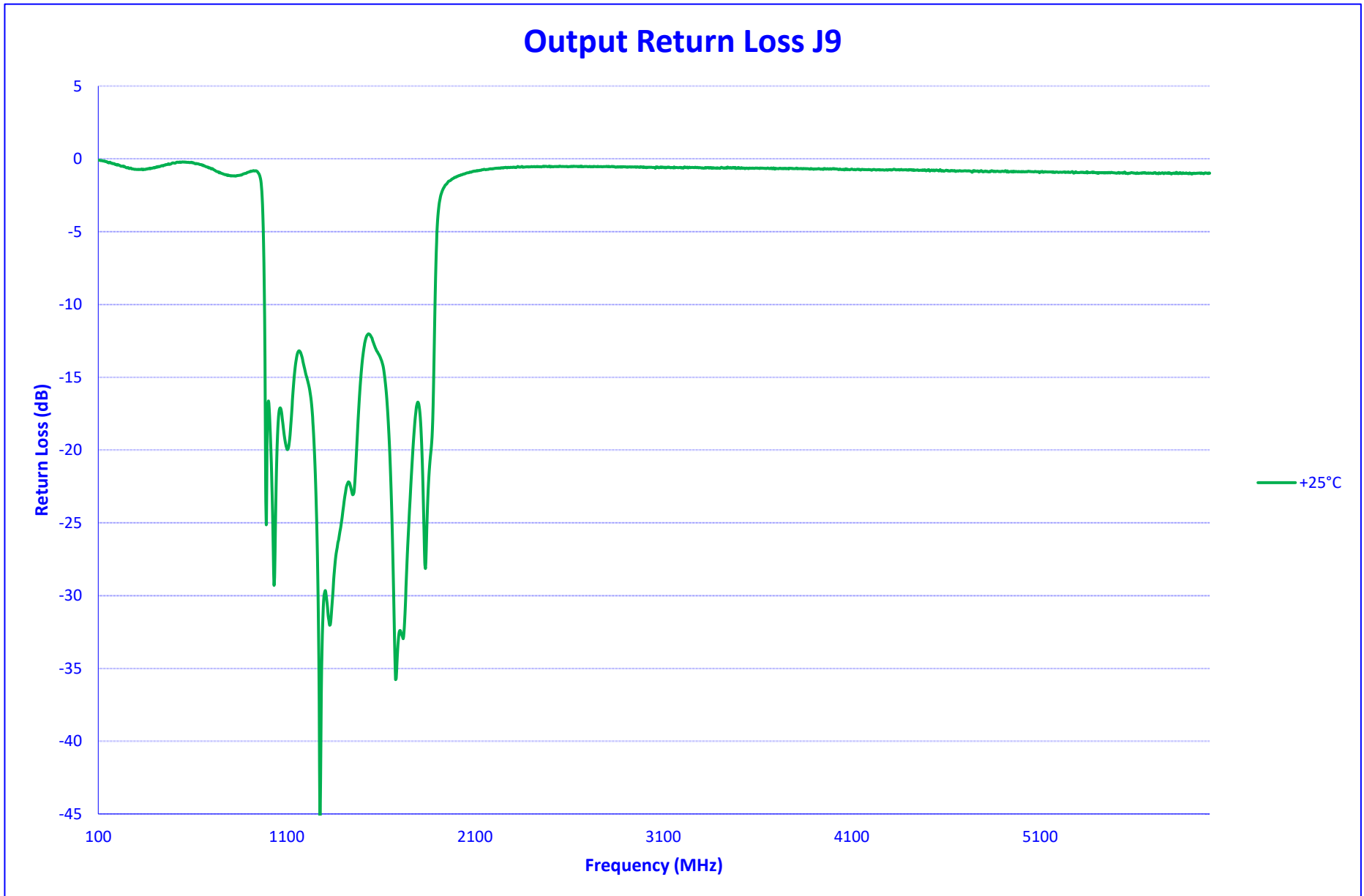



**TYPICAL CHARACTERISTICS
ON
PRX-20-1G18G-850M-SFF-V2**

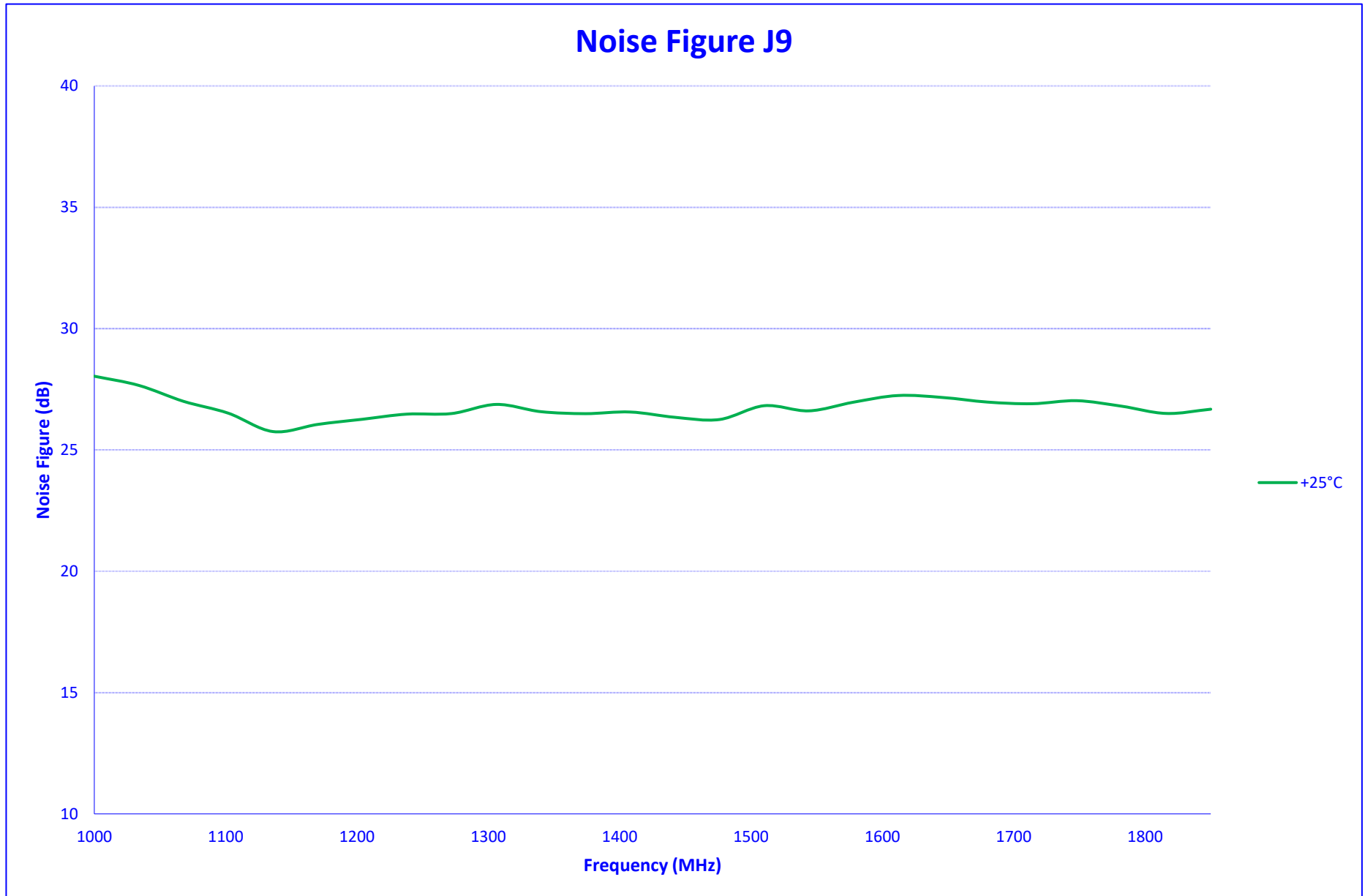



**TYPICAL CHARACTERISTICS
ON
PRX-20-1G18G-850M-SFF-V2**

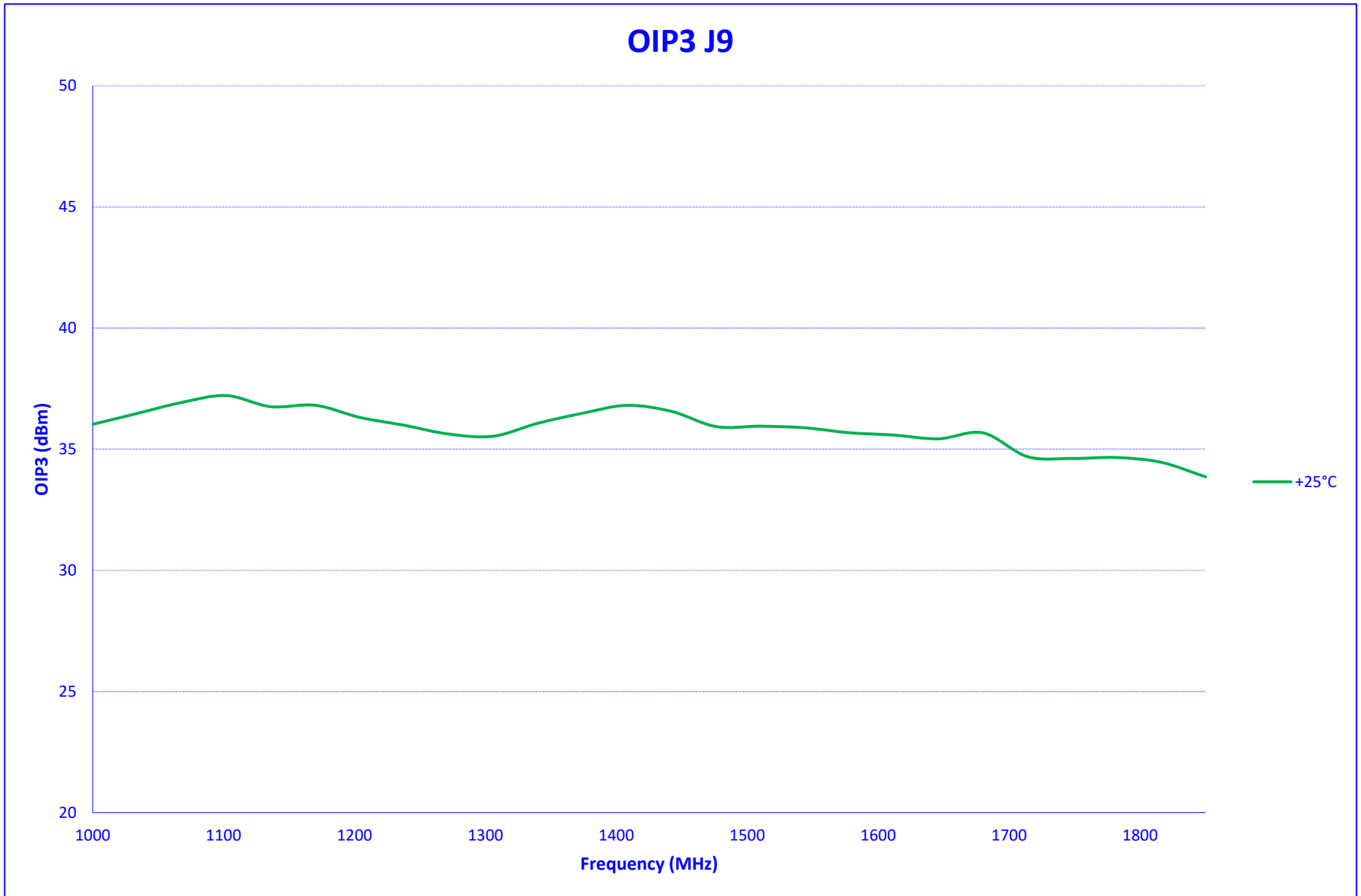



TYPICAL CHARACTERISTICS
ON
PRX-20-1G18G-850M-SFF-V2

IN BAND SPURS J9

25°C

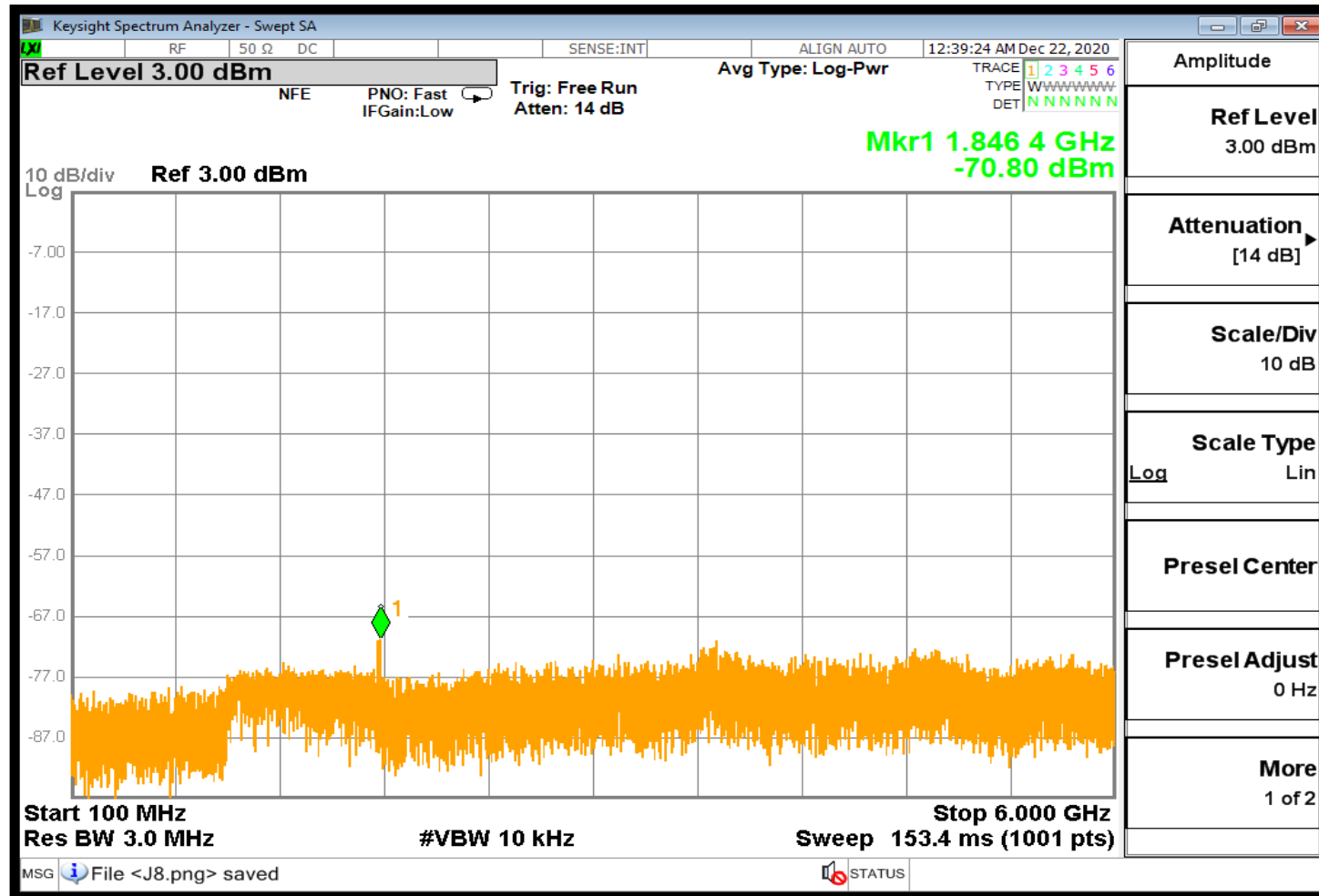



**TYPICAL CHARACTERISTICS
ON
PRX-20-1G18G-850M-SFF-V2**

SUMMARY DATA J10

TEST NO	PARAMETERS	SPECIFIED VALUE	TEST RESULTS
Input Frequency: 9500 - 10350 MHz			+25°C
1	Frequency Range J10:	1850 MHz to 2700 MHz	1850 MHz to 2700 MHz
2	Power Input:	-60 to 0 dBm	-60 to 0 dBm
3	Gain J10:	0 dB ± 3 dB	-0.2 ± 1.1 dB
4	Noise Figure J10:	35 dB Typ	27.53 dB
5	Output IP3 J10:	30 dBm Typ	36.87 dBm
6	Output VSWR J10:	2 : 1 Max	1.3 : 1
7	Passband J10:	Lower 1840 MHz Typ	1800 MHz
		Upper 2710 MHz Typ	2726 MHz
		Passband 870 MHz Typ	926 MHz
8	Stopband J10:	Lower 1635 MHz Typ	1711 MHz
		Upper 2915 MHz Typ	2829 MHz
		Stopband 1400 MHz Max	1117 MHz
9	Worst Case Spur: (Powered, No RF Input)	-60 dBm Typ	-70.77 dBm
10	Inband Worst Case Spur: (1-18 GHz RF Input)	-60 dBm Typ	-66.23 dBm



**TYPICAL CHARACTERISTICS
ON
PRX-20-1G18G-850M-SFF-V2**

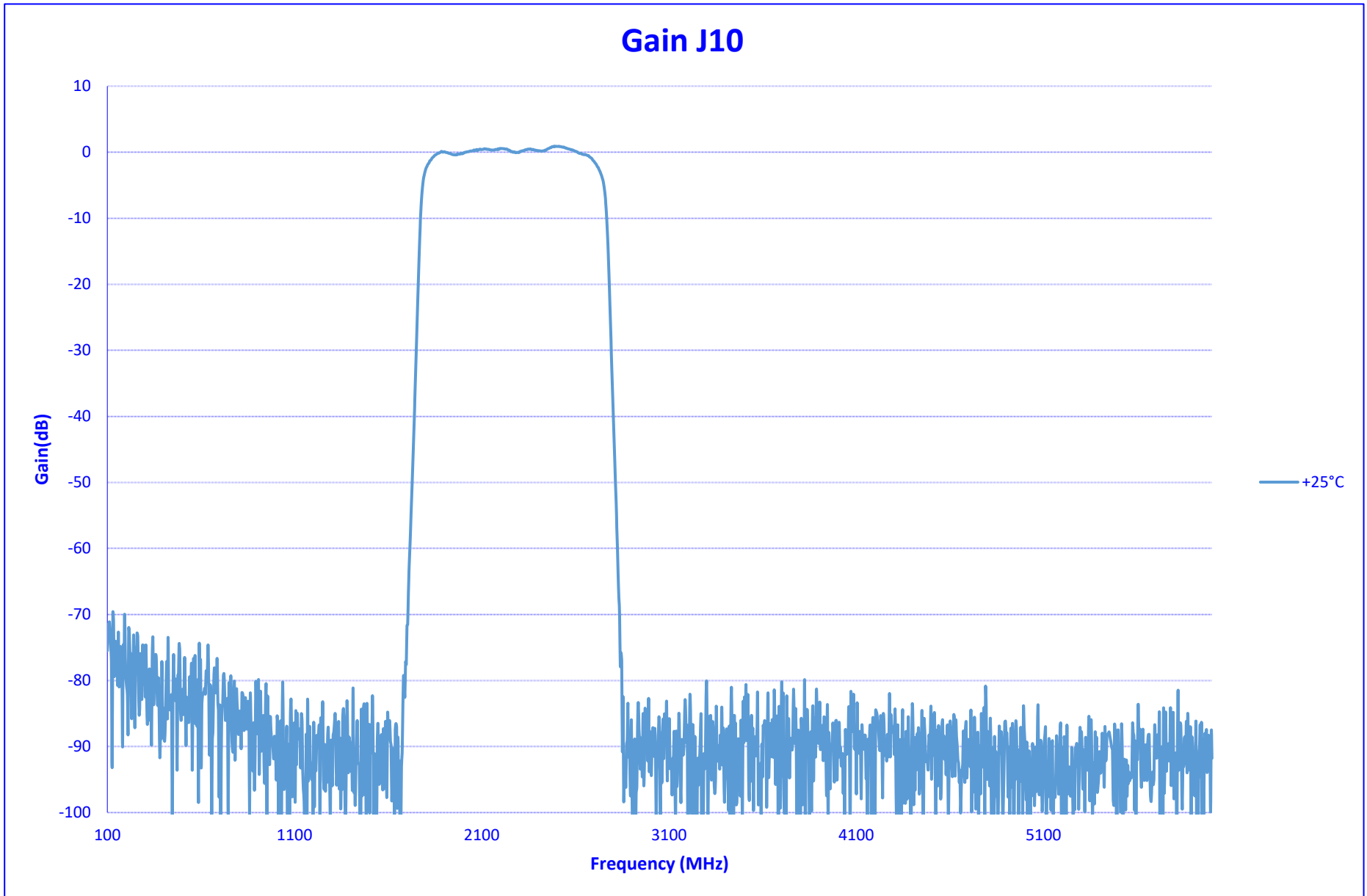



**TYPICAL CHARACTERISTICS
ON
PRX-20-1G18G-850M-SFF-V2**

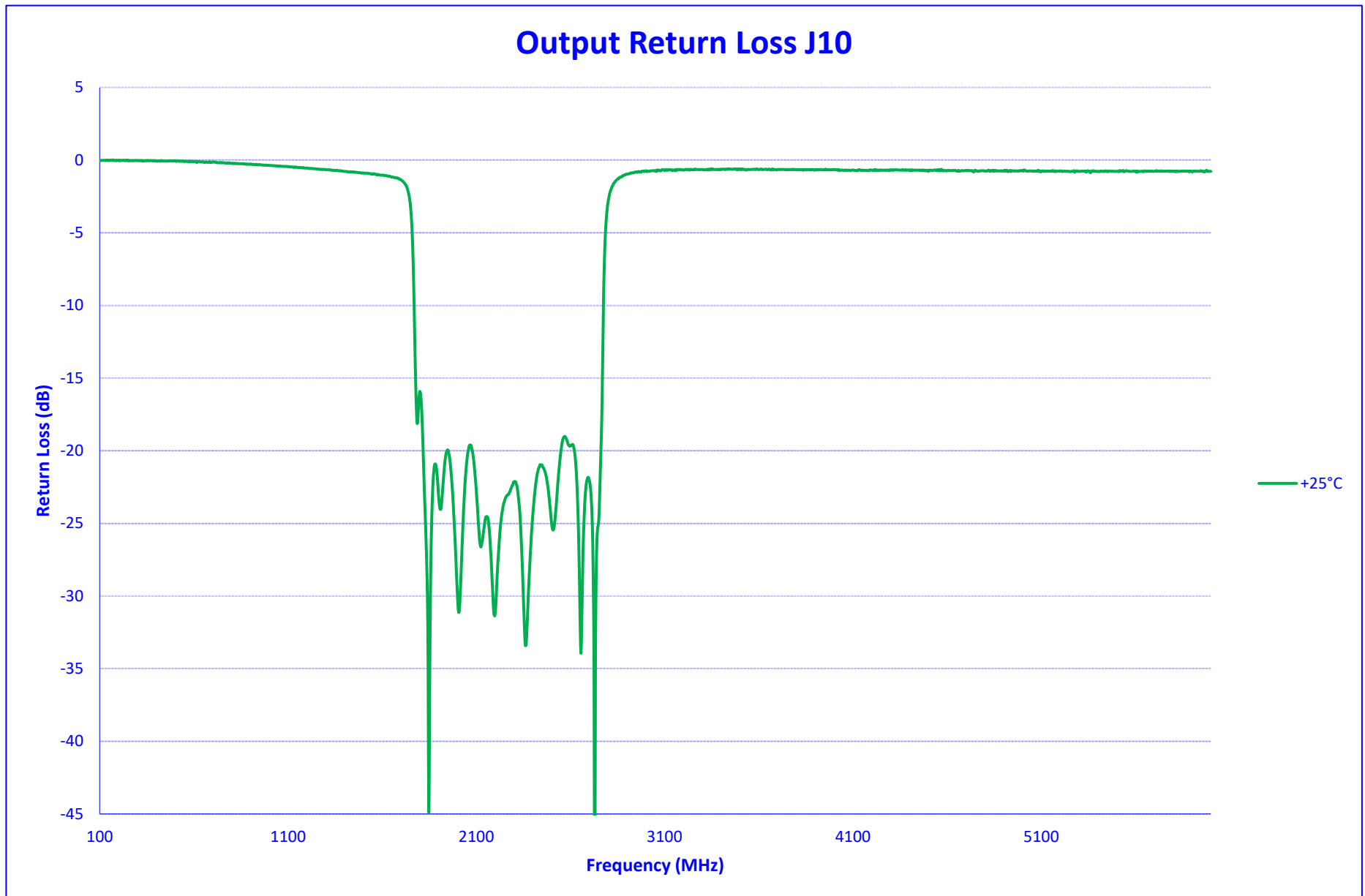



**TYPICAL CHARACTERISTICS
ON
PRX-20-1G18G-850M-SFF-V2**

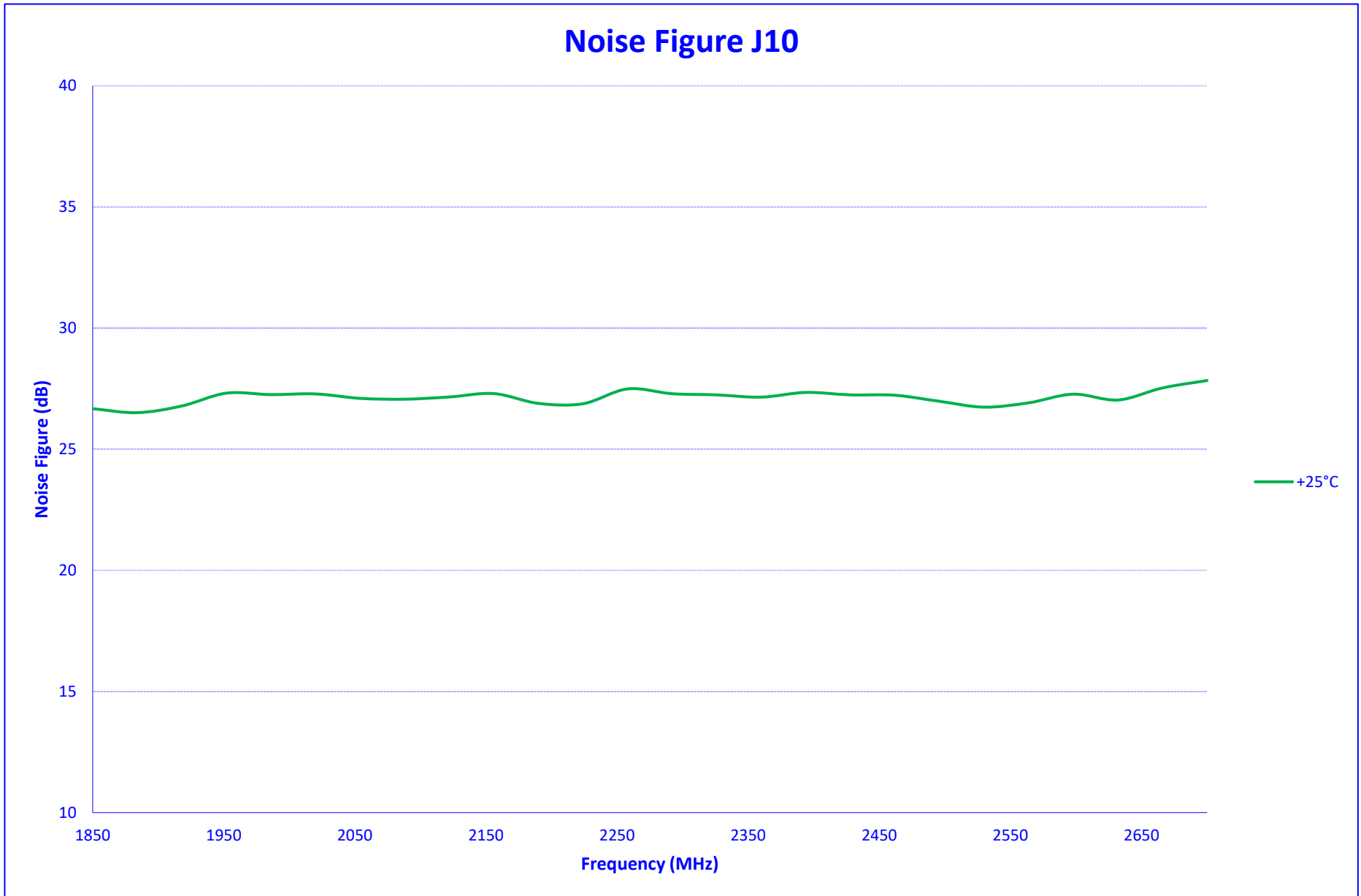



**TYPICAL CHARACTERISTICS
ON
PRX-20-1G18G-850M-SFF-V2**

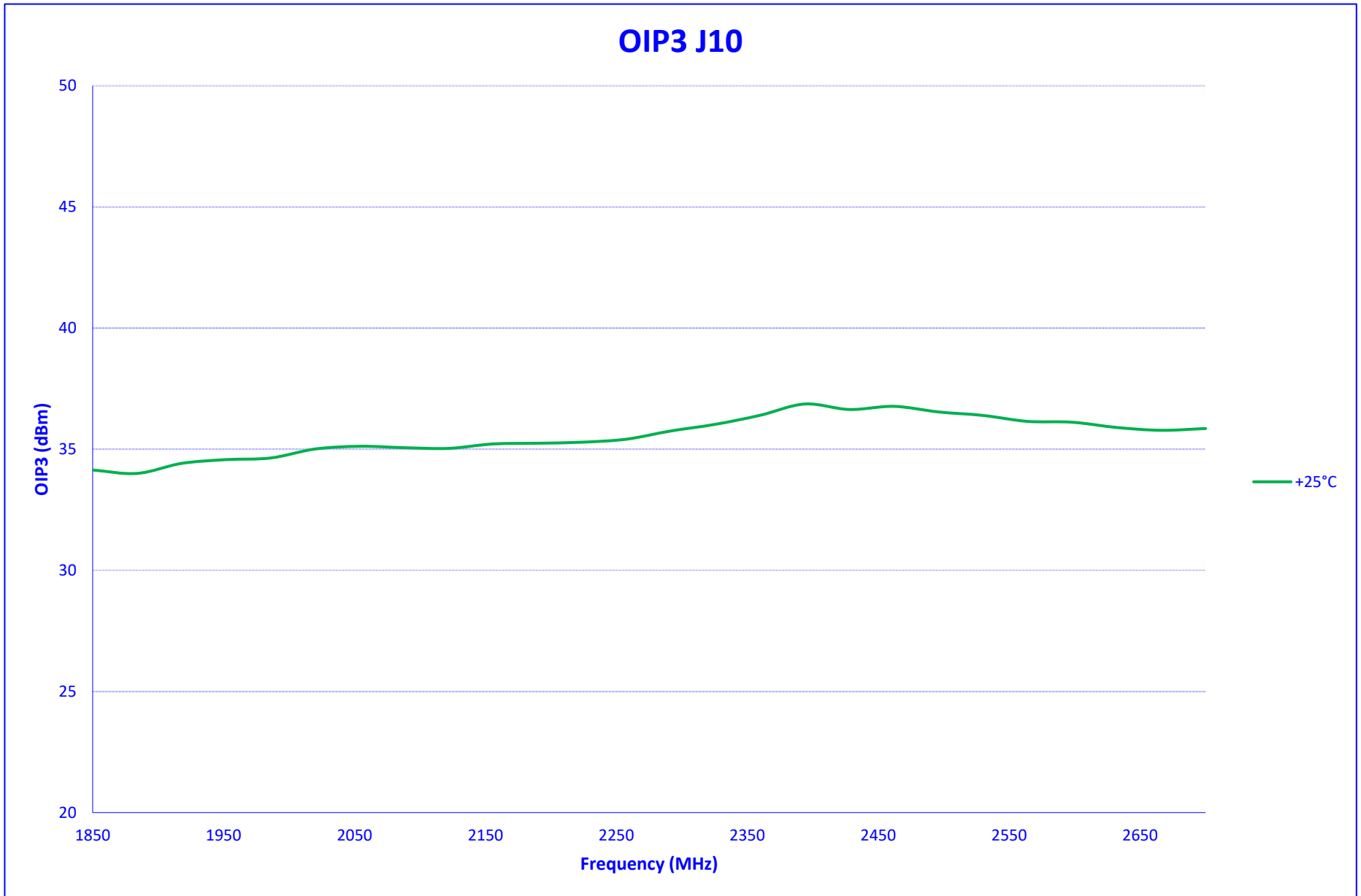



TYPICAL CHARACTERISTICS
ON
PRX-20-1G18G-850M-SFF-V2

IN BAND SPURS J10

25°C

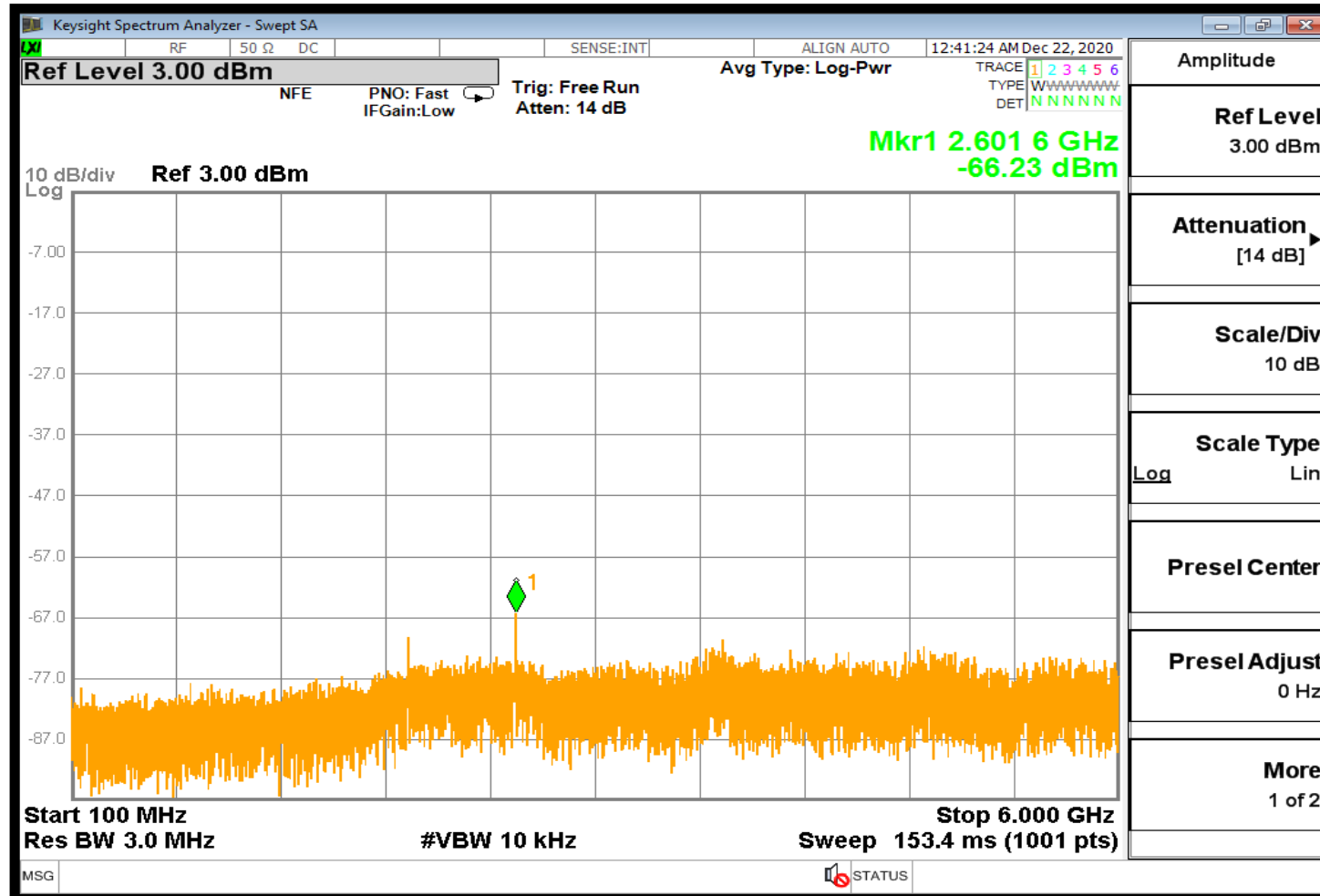



**TYPICAL CHARACTERISTICS
ON
PRX-20-1G18G-850M-SFF-V2**

SUMMARY DATA J11

TEST NO	PARAMETERS	SPECIFIED VALUE	TEST RESULTS
Input Frequency: 8650 - 9500 MHz			+25°C
1	Frequency Range J11:	2700 MHz to 3550 MHz	2700 MHz to 3550 MHz
2	Power Input:	-60 to 0 dBm	-60 to 0 dBm
3	Gain J11:	0 dB ± 3 dB	-0.6 ± 2.2 dB
4	Noise Figure J11:	35 dB Typ	28.05 dB
5	Output IP3 J11:	30 dBm Typ	38.62 dBm
6	Output VSWR J11:	2 : 1 Max	1.4 : 1
7	Passband J11:	Lower 2690 MHz Typ	2659 MHz
		Upper 3560 MHz Typ	3577 MHz
		Passband 870 MHz Typ	918 MHz
8	Stopband J11:	Lower 2485 MHz Typ	2560 MHz
		Upper 3765 MHz Typ	3706 MHz
		Stopband 1400 MHz Max	1147 MHz
9	Worst Case Spur: (Powered, No RF Input)	-60 dBm Typ	-71.26 dBm
10	Inband Worst Case Spur: (1-18 GHz RF Input)	-60 dBm Typ	-62.33 dBm



**TYPICAL CHARACTERISTICS
ON
PRX-20-1G18G-850M-SFF-V2**

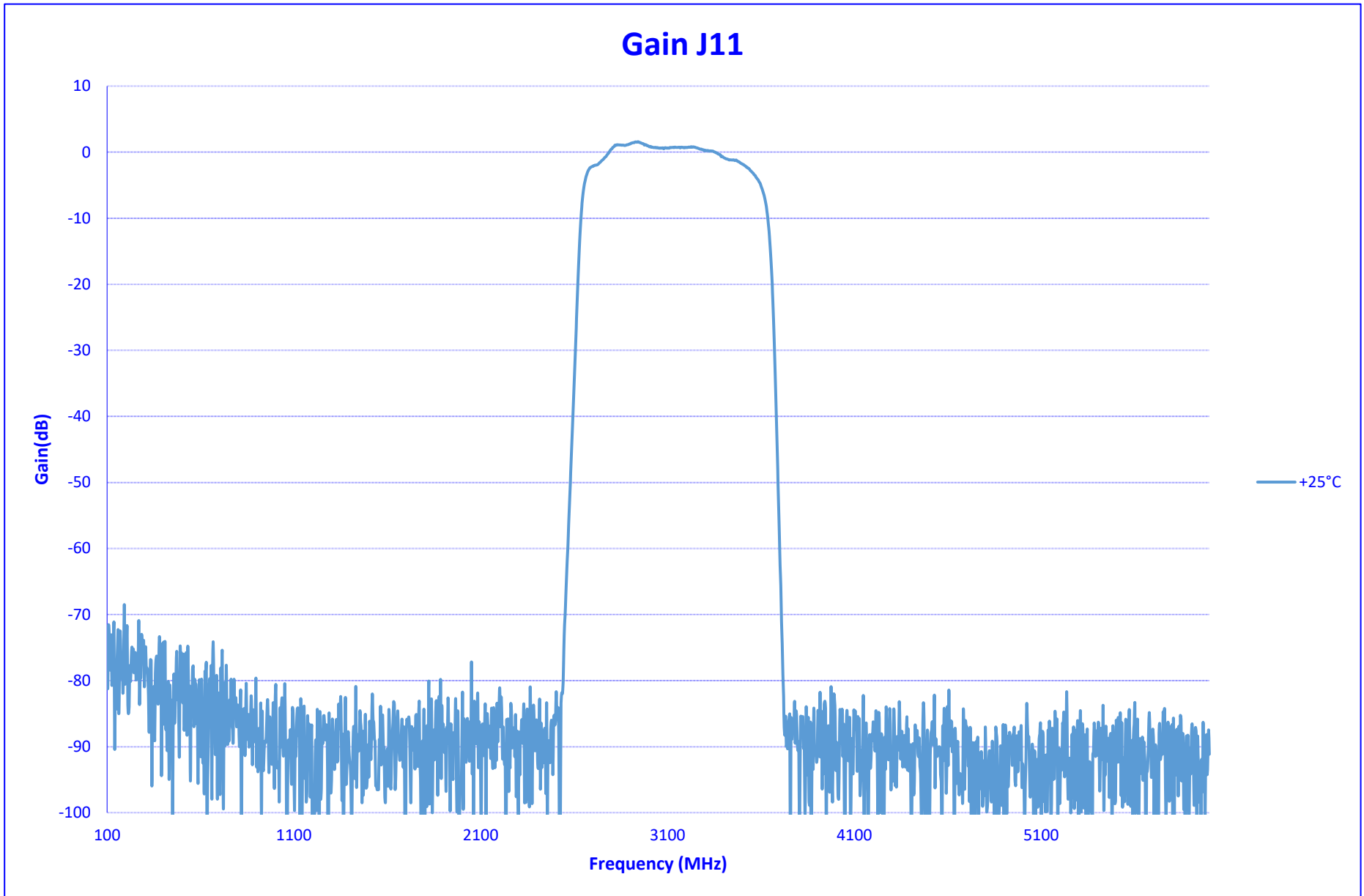



**TYPICAL CHARACTERISTICS
ON
PRX-20-1G18G-850M-SFF-V2**

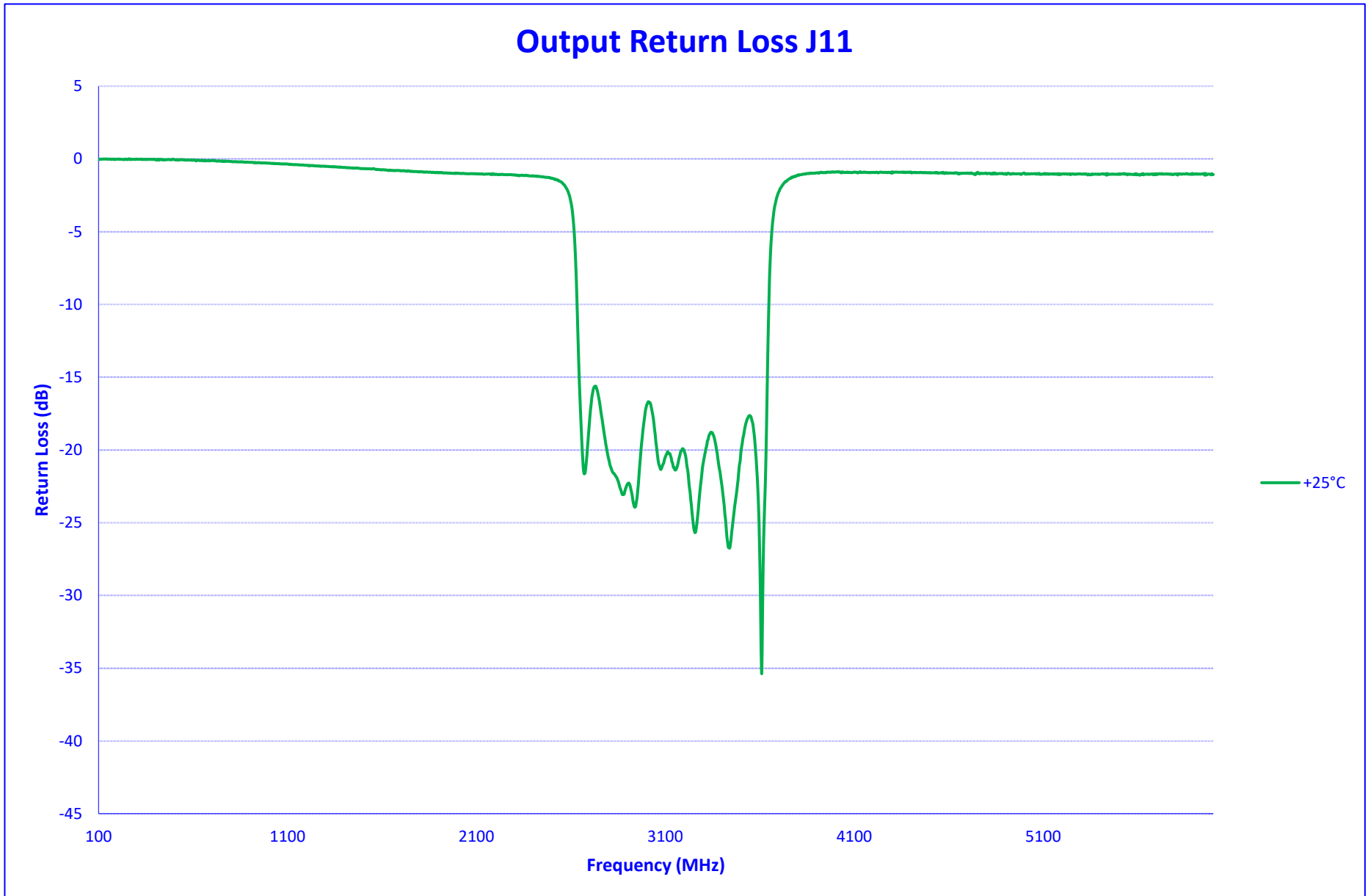



**TYPICAL CHARACTERISTICS
ON
PRX-20-1G18G-850M-SFF-V2**

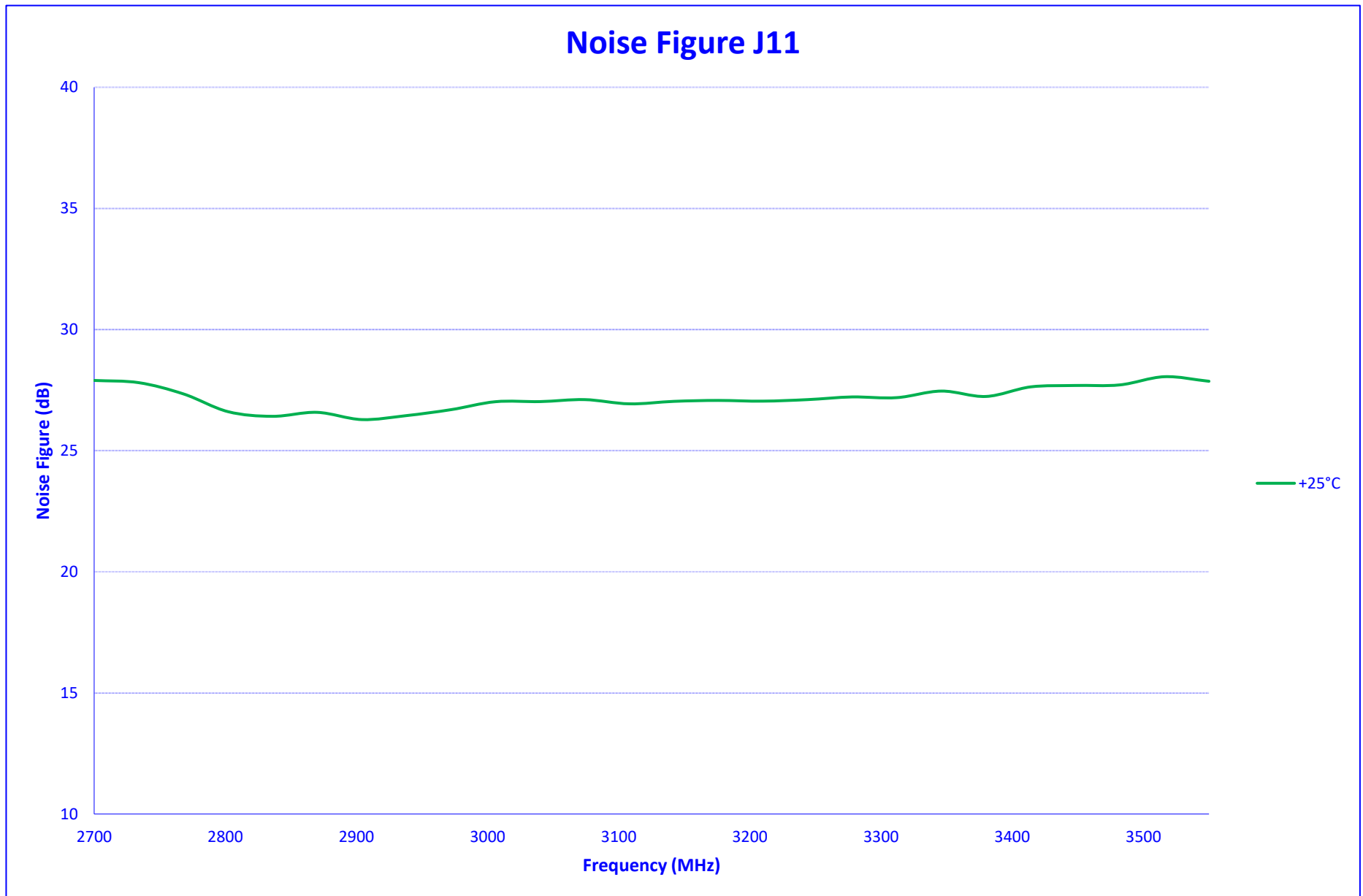



**TYPICAL CHARACTERISTICS
ON
PRX-20-1G18G-850M-SFF-V2**

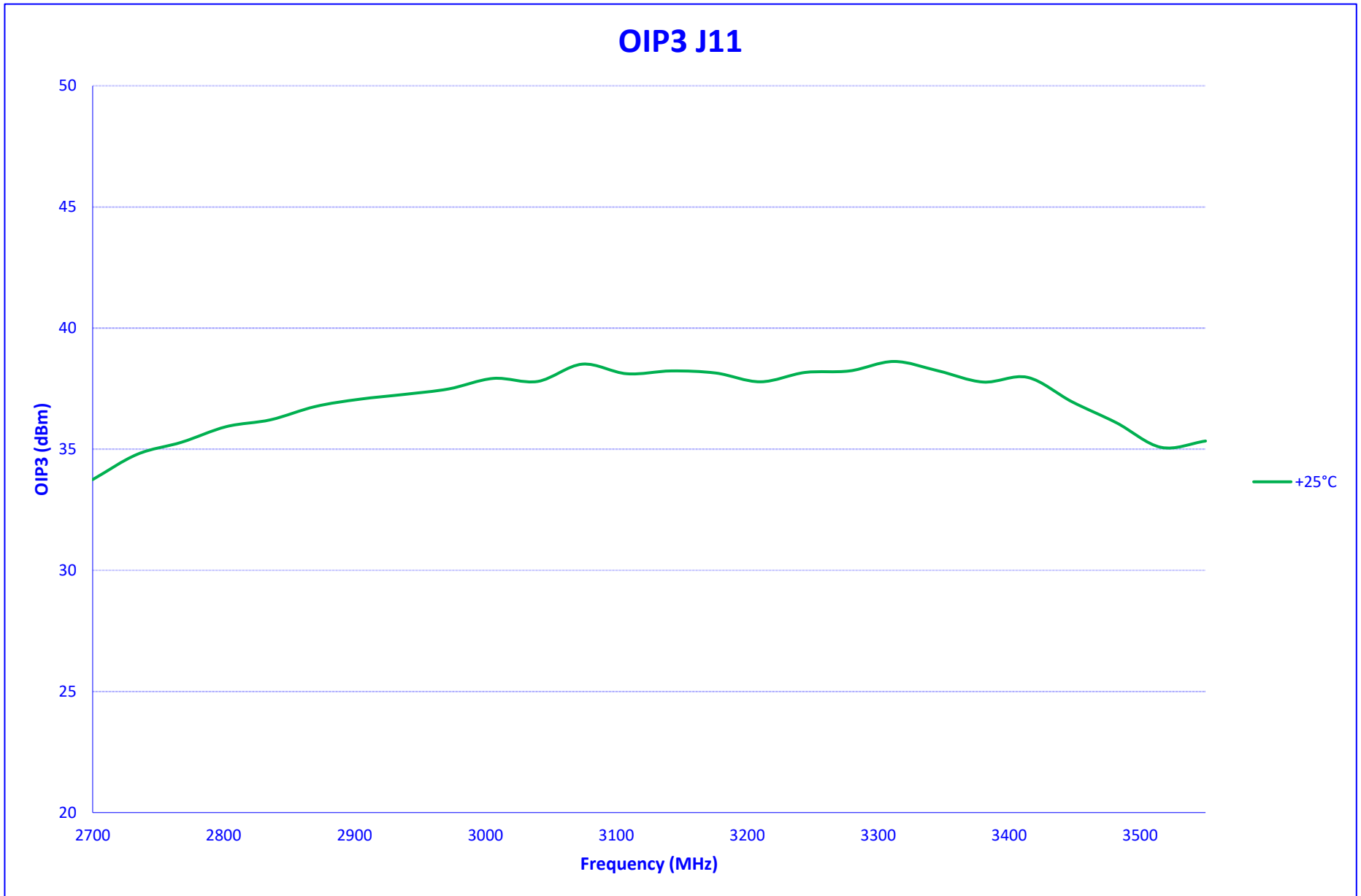



TYPICAL CHARACTERISTICS
ON
PRX-20-1G18G-850M-SFF-V2

IN BAND SPURS J11

25°C

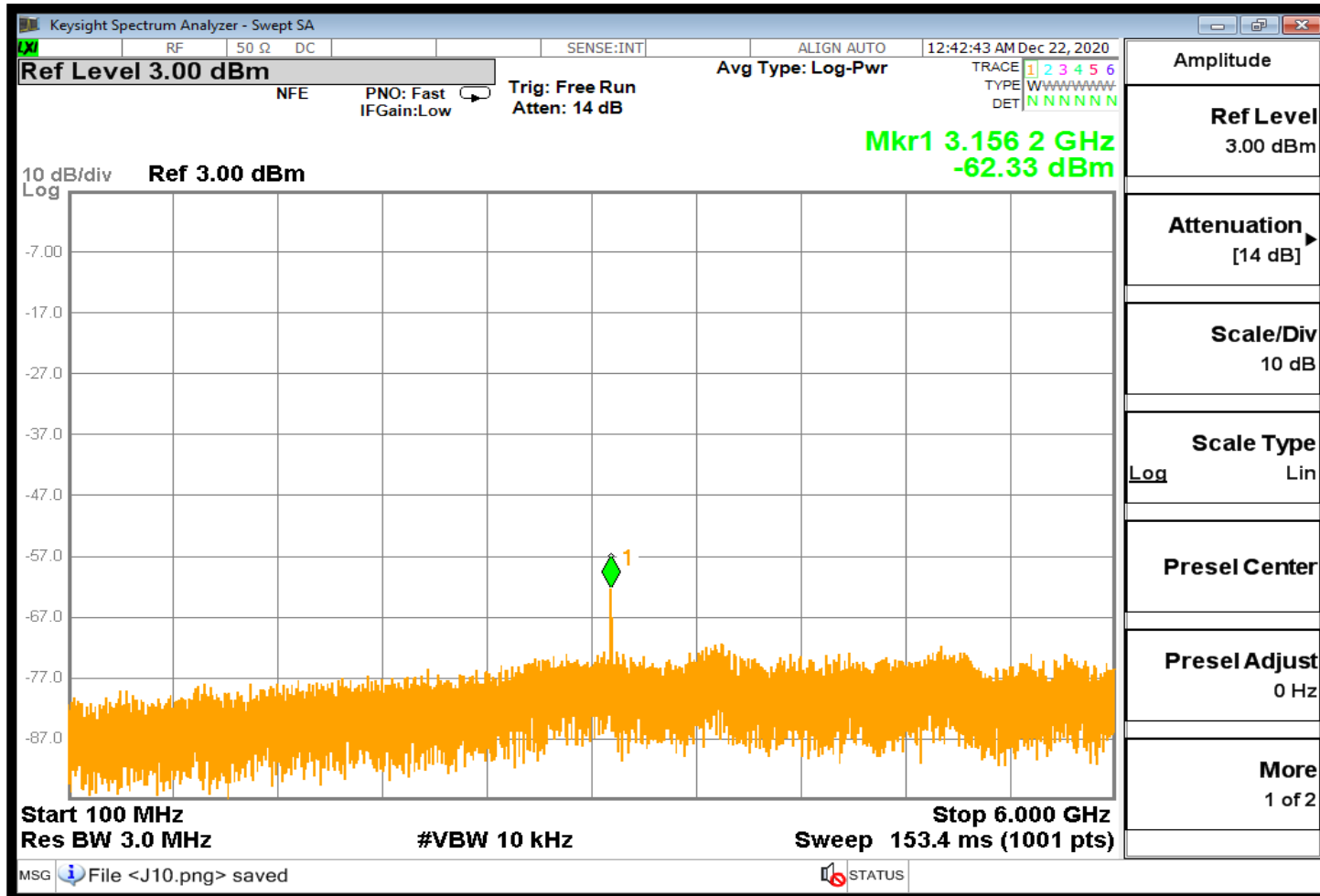



**TYPICAL CHARACTERISTICS
ON
PRX-20-1G18G-850M-SFF-V2**

SUMMARY DATA J12

TEST NO	PARAMETERS	SPECIFIED VALUE	TEST RESULTS
Input Frequency: 7800 - 8650 MHz			+25°C
1	Frequency Range J12:	3550 MHz to 4400 MHz	3550 MHz to 4400 MHz
2	Power Input:	-60 to 0 dBm	-60 to 0 dBm
3	Gain J12:	0 dB ± 3 dB	0 ± 1.3 dB
4	Noise Figure J12:	35 dB Typ	29.62 dB
5	Output IP3 J12:	30 dBm Typ	31.77 dBm
6	Output VSWR J12:	2 : 1 Max	1.6 : 1
7	Passband J12:	Lower 3540 MHz Typ	3526 MHz
		Upper 4410 MHz Typ	4425 MHz
		Passband 870 MHz Typ	900 MHz
8	Stopband J12:	Lower 3275MHz Typ	3426 MHz
		Upper 4675 MHz Typ	4525 MHz
		Stopband 1400 MHz Max	1099 MHz
9	Worst Case Spur: (Powered, No RF Input)	-60 dBm Typ	-71.14 dBm
10	Inband Worst Case Spur: (1-18 GHz RF Input)	-60 dBm Typ	-61.09 dBm



**TYPICAL CHARACTERISTICS
ON
PRX-20-1G18G-850M-SFF-V2**

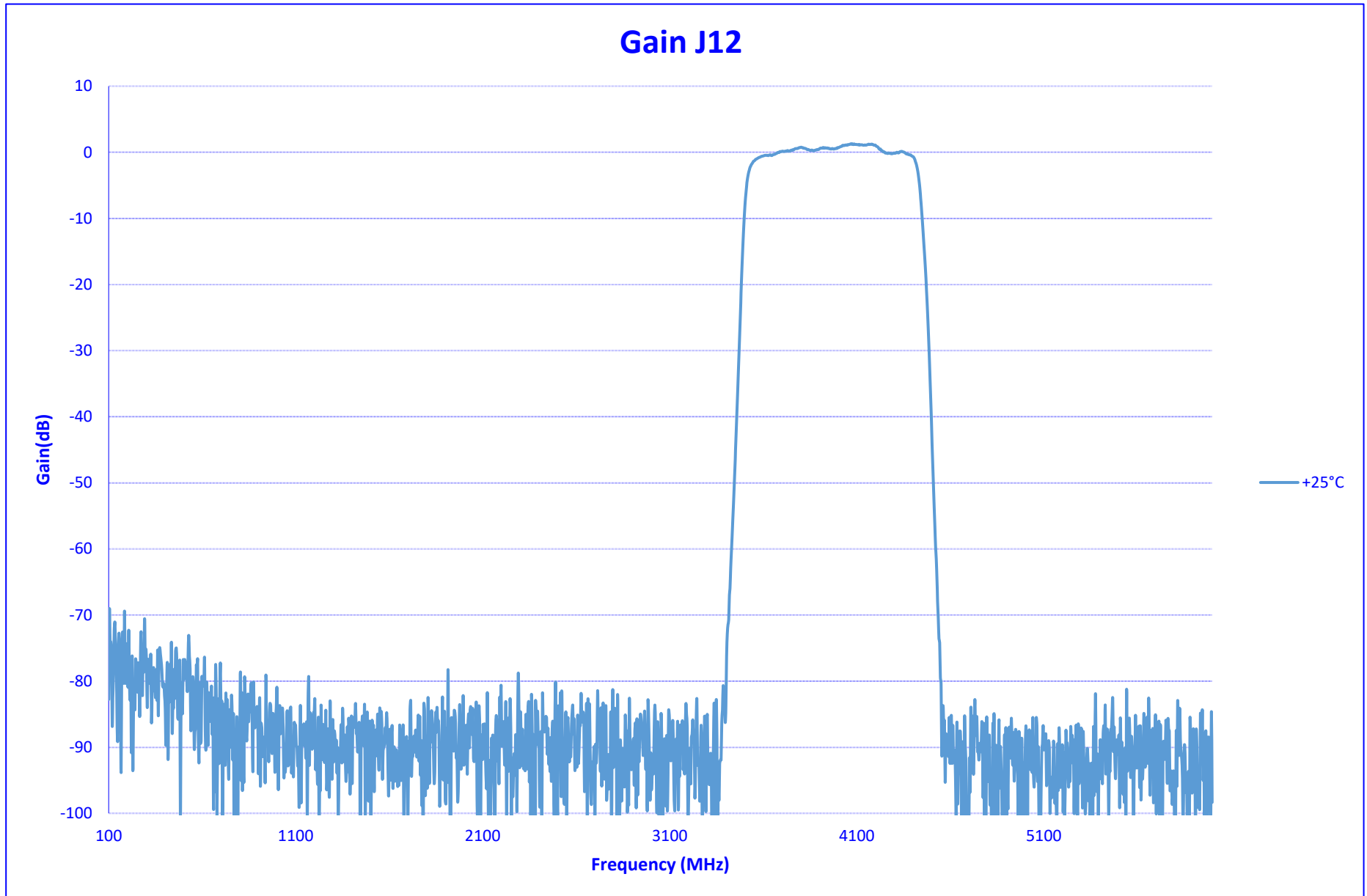



TYPICAL CHARACTERISTICS
ON
PRX-20-1G18G-850M-SFF-V2

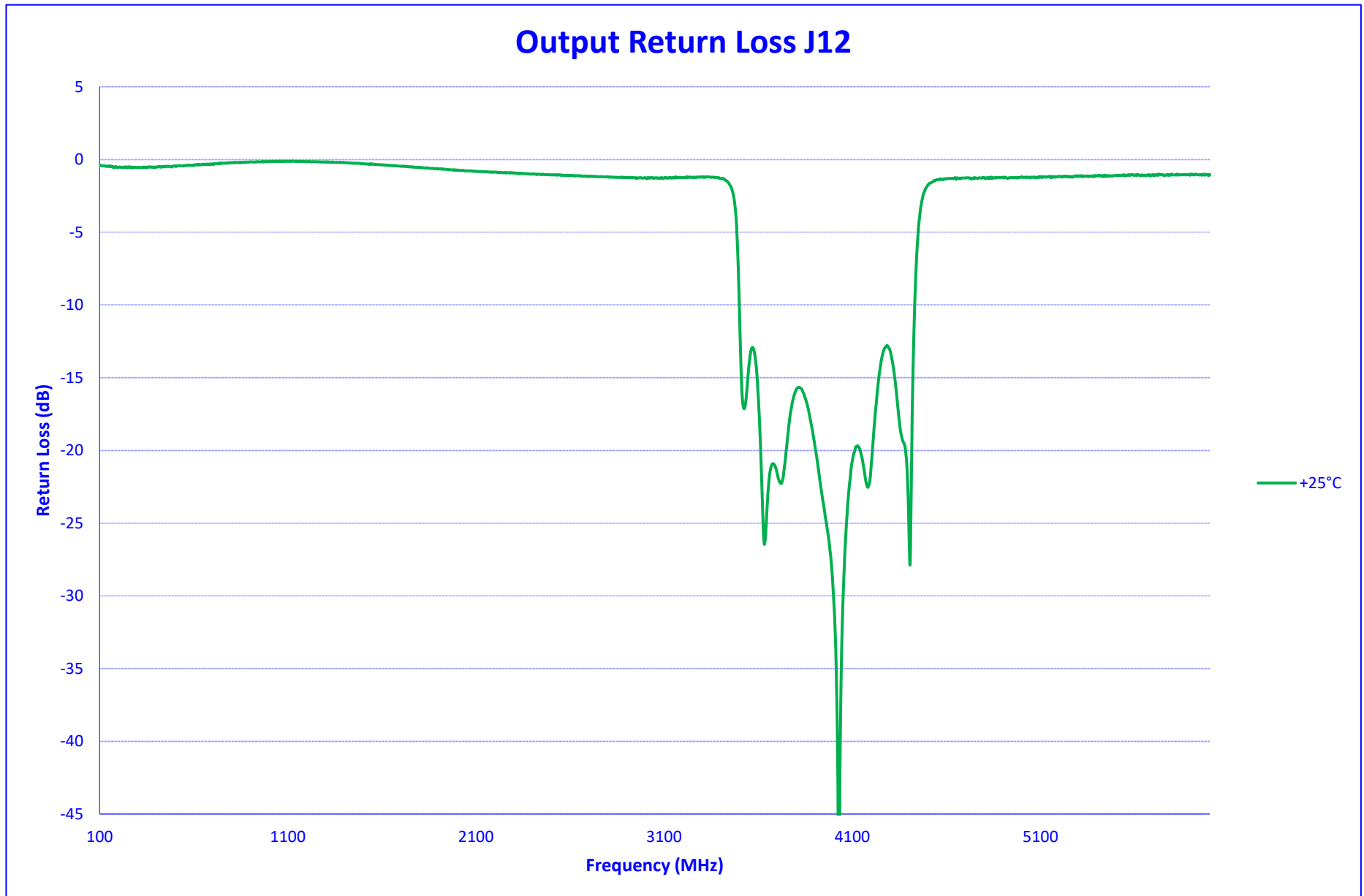



**TYPICAL CHARACTERISTICS
ON
PRX-20-1G18G-850M-SFF-V2**

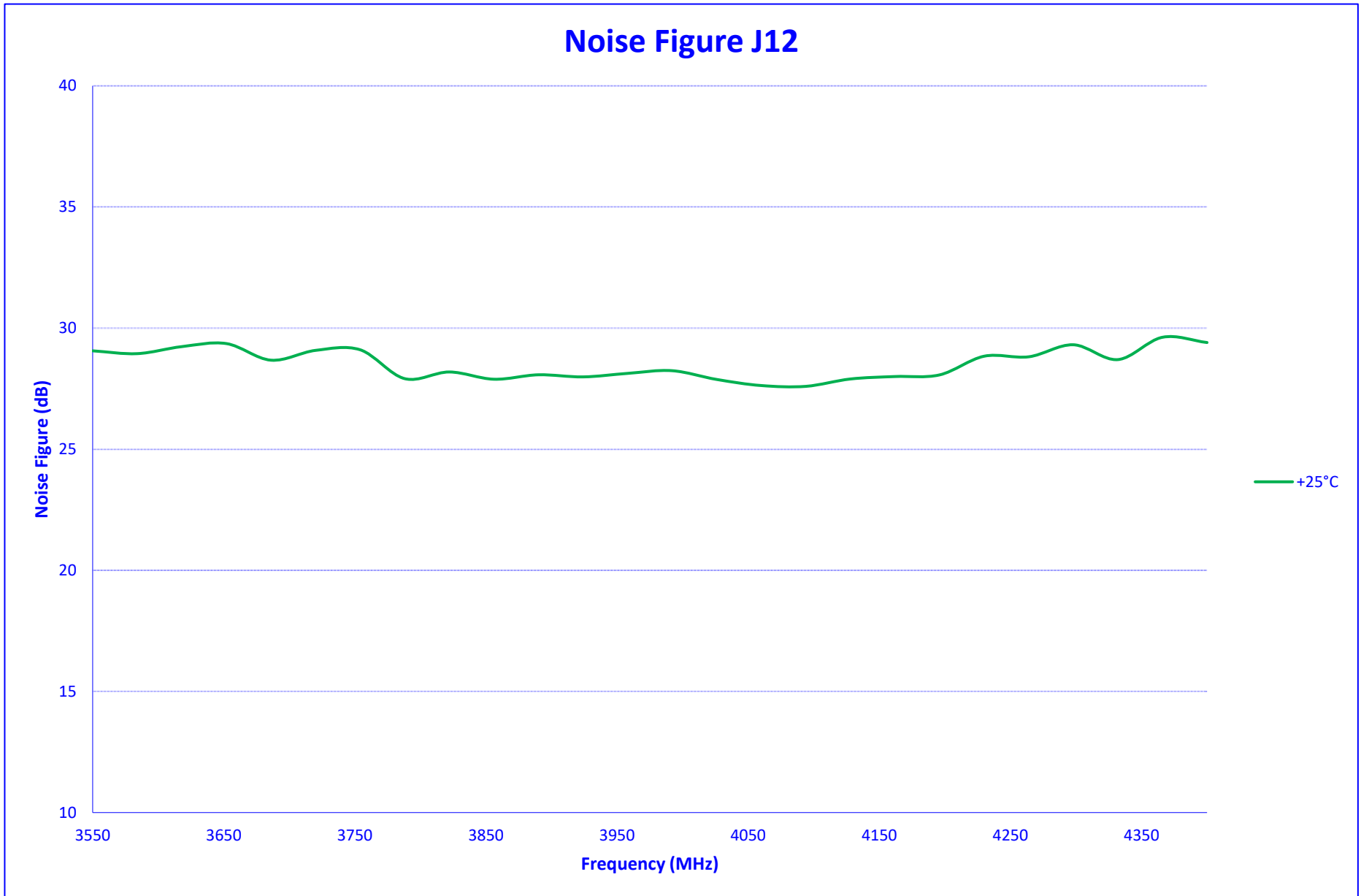



**TYPICAL CHARACTERISTICS
ON
PRX-20-1G18G-850M-SFF-V2**

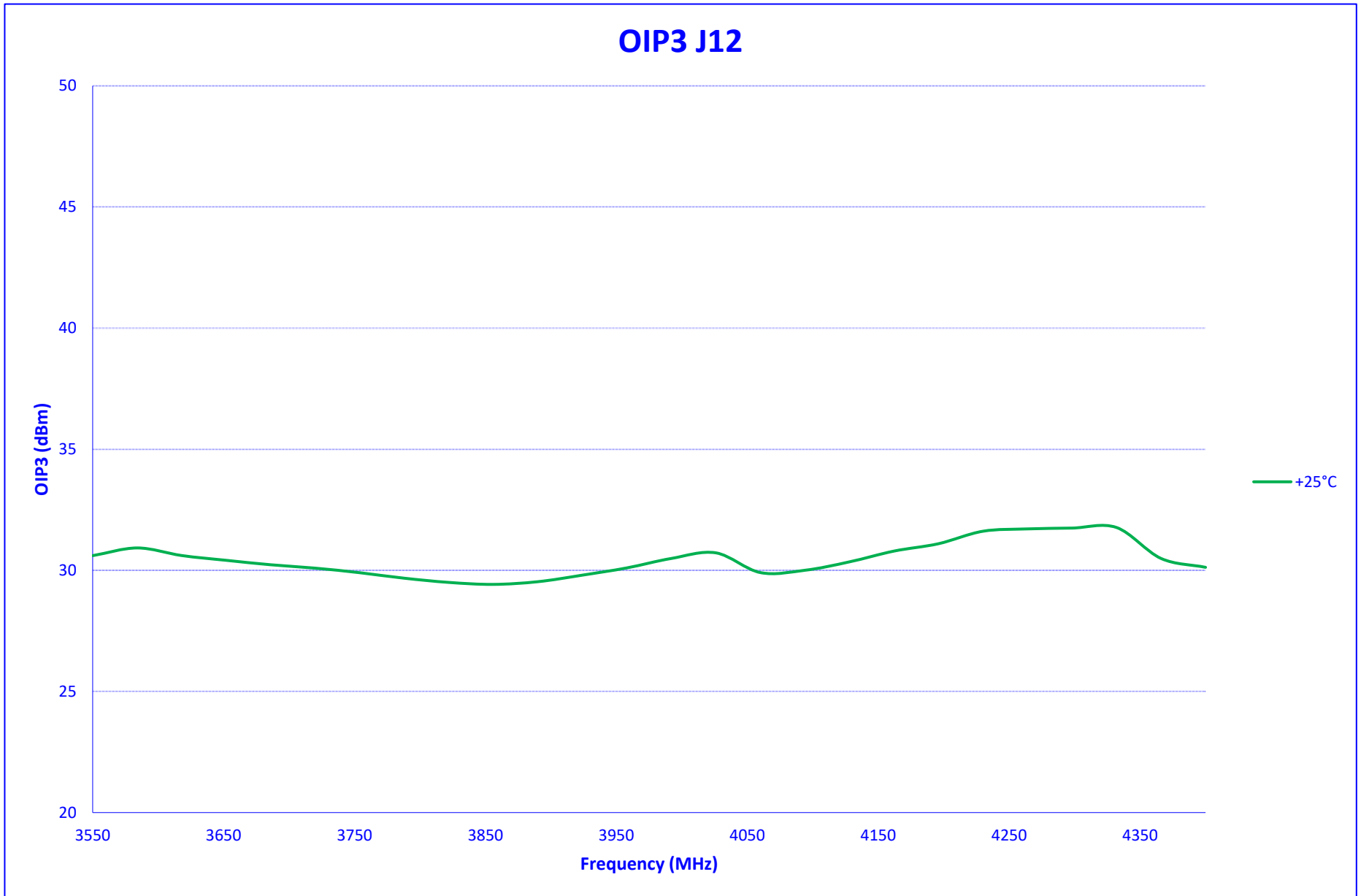



TYPICAL CHARACTERISTICS
ON
PRX-20-1G18G-850M-SFF-V2

IN BAND SPURS J12

25°C

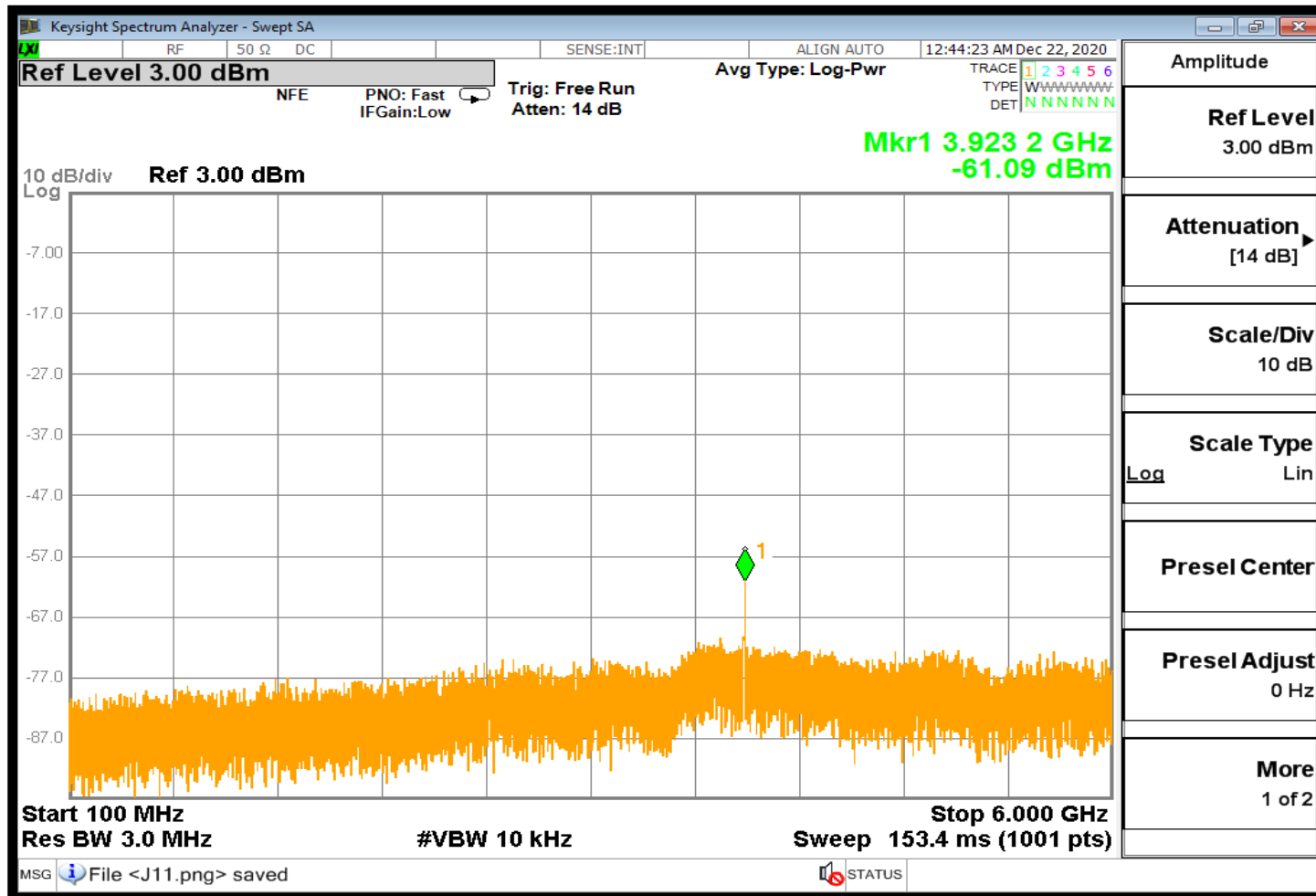



**TYPICAL CHARACTERISTICS
ON
PRX-20-1G18G-850M-SFF-V2**

SUMMARY DATA J13

TEST NO	PARAMETERS	SPECIFIED VALUE	TEST RESULTS
Input Frequency: 11200 - 12050 MHz			+25°C
1	Frequency Range J13:	1000 MHz to 1850 MHz	1000 MHz to 1850 MHz
2	Power Input:	-60 to 0 dBm	-60 to 0 dBm
3	Gain J13:	0 dB ± 3 dB	0.2 ± 2.7 dB
4	Noise Figure J13:	35 dB Typ	27.62 dB
5	Output IP3 J13:	30 dBm Typ	37.05 dBm
6	Output VSWR J13:	2 : 1 Max	1.7 : 1
7	Passband J13:	Lower 990 MHz Typ	981 MHz
		Upper 1860 MHz Typ	1870 MHz
		Passband 870 MHz Typ	889 MHz
8	Stopband J13:	Lower 890 MHz Typ	933 MHz
		Upper 1980 MHz Typ	1936 MHz
		Stopband 1400 MHz Max	1003 MHz
9	Worst Case Spur: (Powered, No RF Input)	-60 dBm Typ	-72.18 dBm
10	Inband Worst Case Spur: (1-18 GHz RF Input)	-60 dBm Typ	-67.23 dBm



**TYPICAL CHARACTERISTICS
ON
PRX-20-1G18G-850M-SFF-V2**

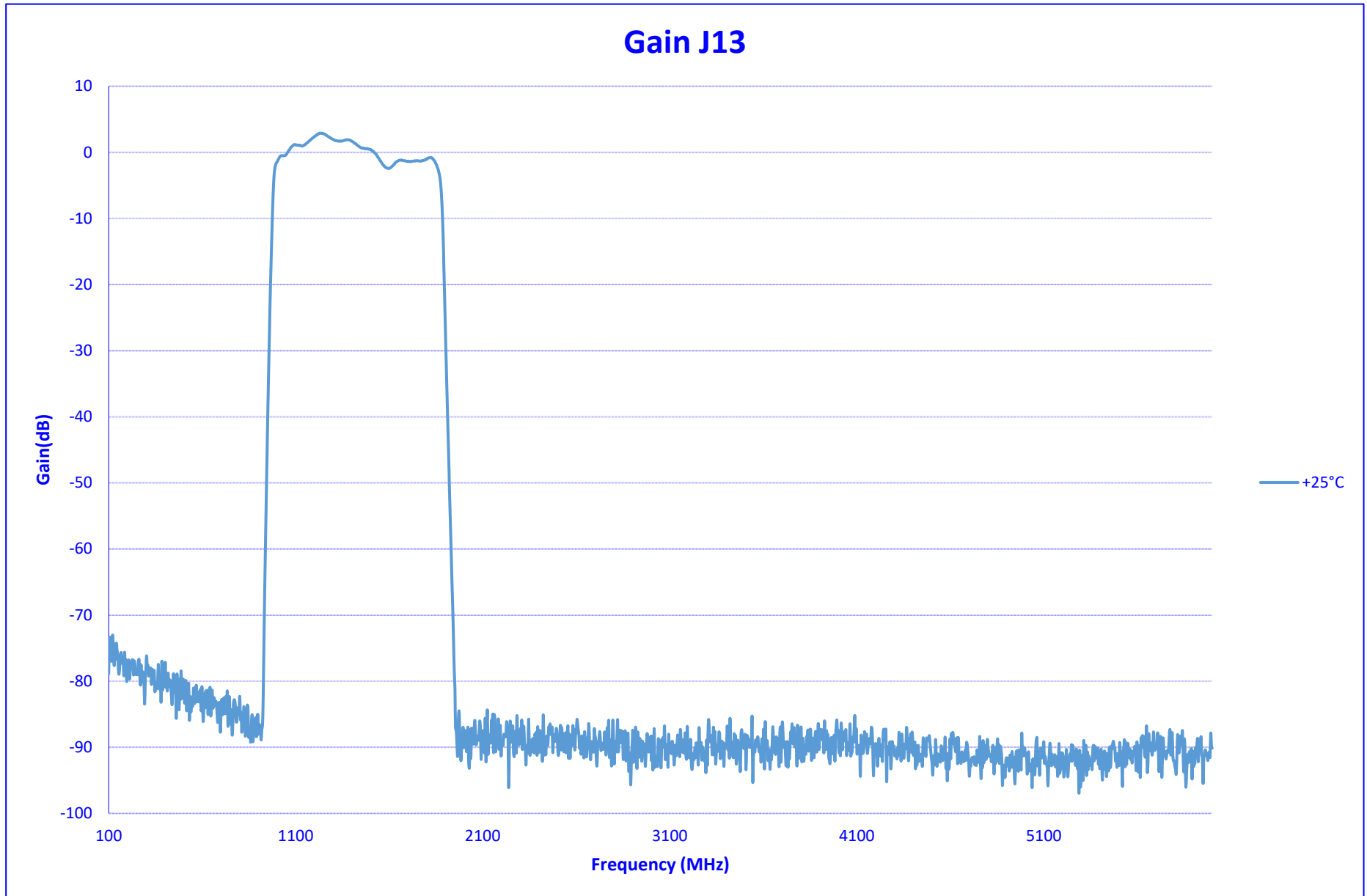



**TYPICAL CHARACTERISTICS
ON
PRX-20-1G18G-850M-SFF-V2**

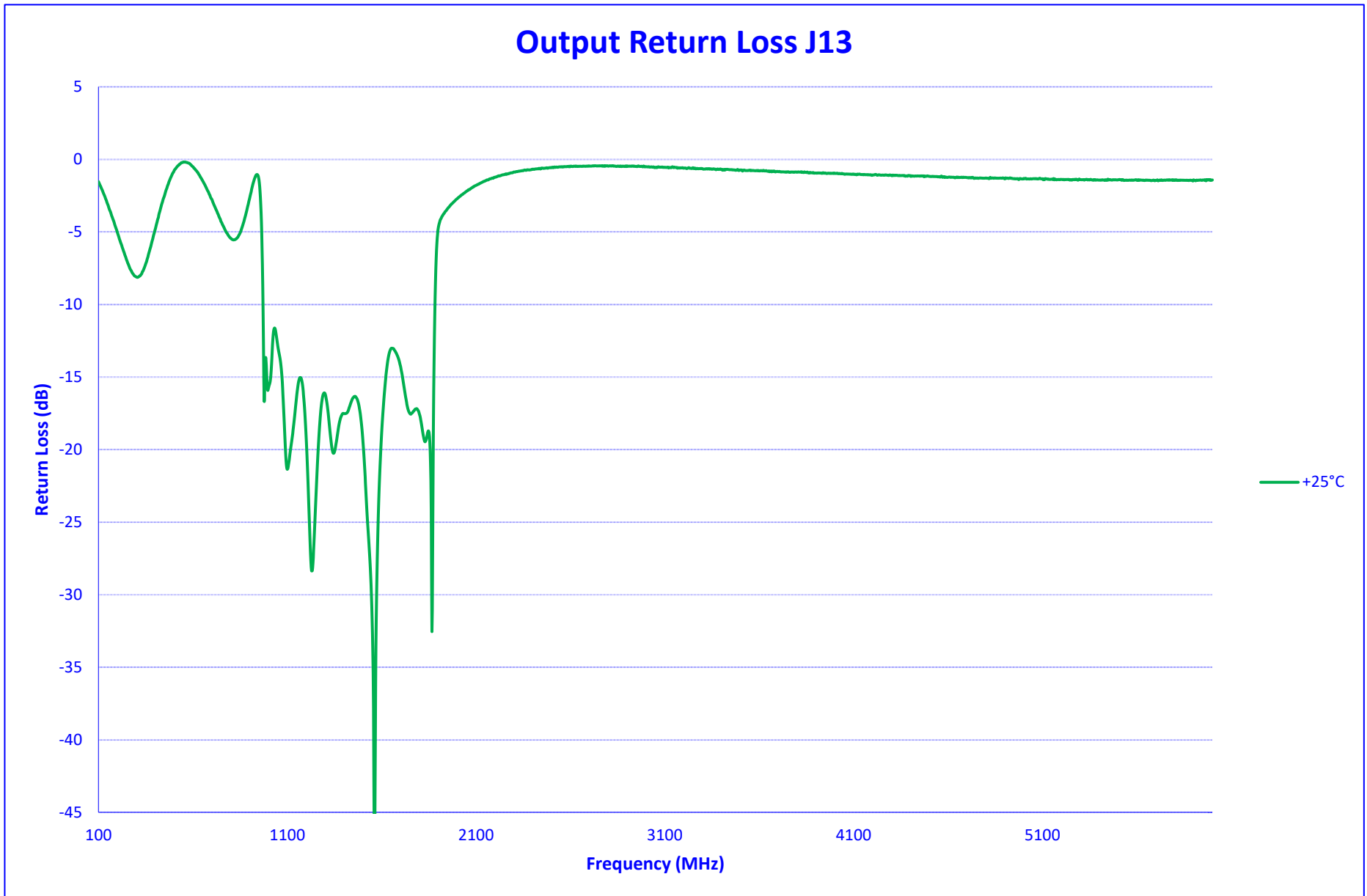



**TYPICAL CHARACTERISTICS
ON
PRX-20-1G18G-850M-SFF-V2**

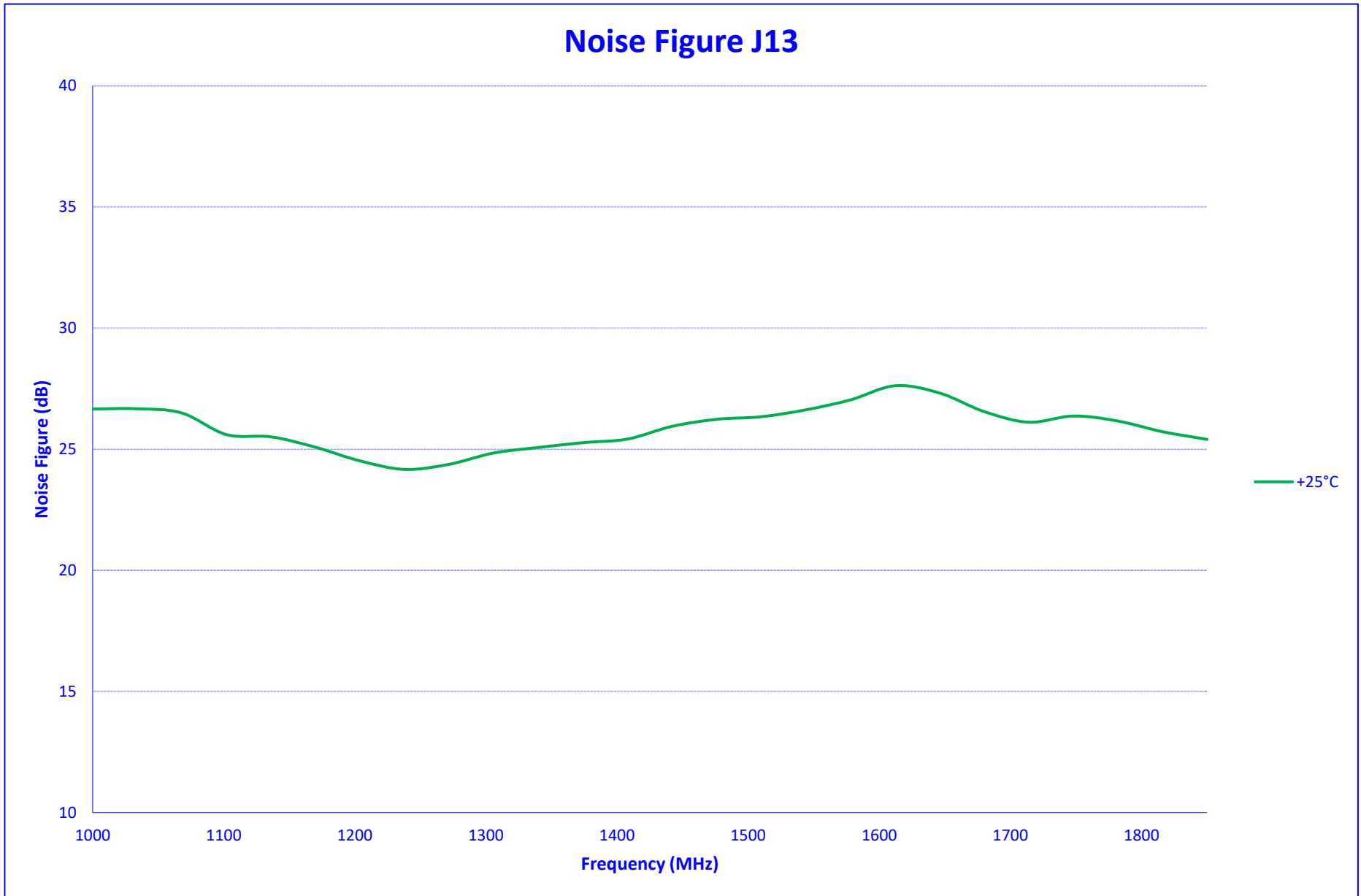



**TYPICAL CHARACTERISTICS
ON
PRX-20-1G18G-850M-SFF-V2**

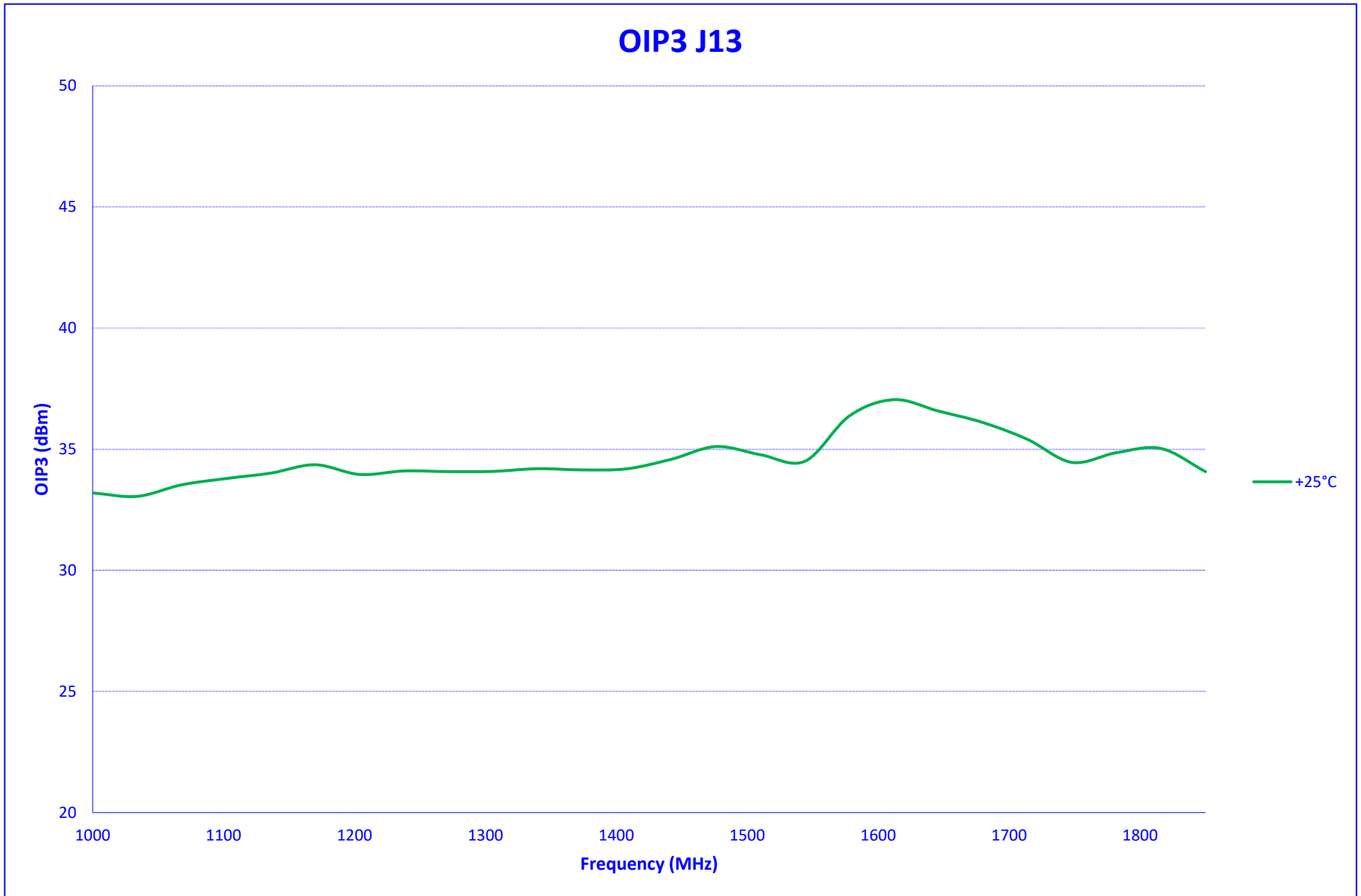



TYPICAL CHARACTERISTICS
ON
PRX-20-1G18G-850M-SFF-V2

IN BAND SPURS J13

25°C

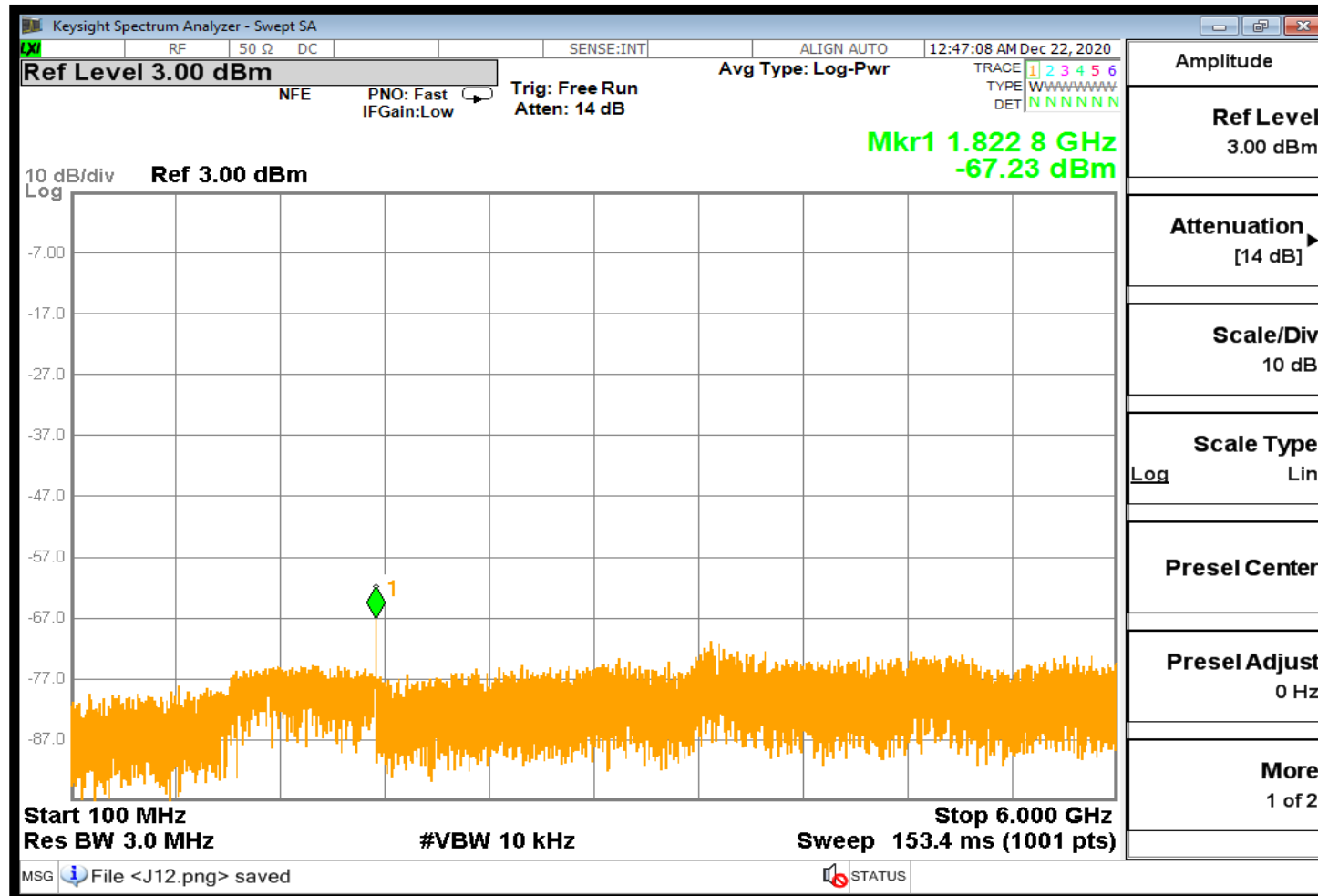



**TYPICAL CHARACTERISTICS
ON
PRX-20-1G18G-850M-SFF-V2**

SUMMARY DATA J14

TEST NO	PARAMETERS	SPECIFIED VALUE	TEST RESULTS
Input Frequency: 12050 - 12900 MHz			+25°C
1	Frequency Range J14:	1850 MHz to 2700 MHz	1850 MHz to 2700 MHz
2	Power Input:	-60 to 0 dBm	-60 to 0 dBm
3	Gain J14:	0 dB ± 3 dB	-1 ± 1.7 dB
4	Noise Figure J14:	35 dB Typ	28.42 dB
5	Output IP3 J14:	30 dBm Typ	37.43 dBm
6	Output VSWR J14:	2 : 1 Max	1.4 : 1
7	Passband J14:	Lower 1840 MHz Typ	1782 MHz
		Upper 2710 MHz Typ	2718 MHz
		Passband 870 MHz Typ	937 MHz
8	Stopband J14:	Lower 1635 MHz Typ	1704 MHz
		Upper 2915 MHz Typ	2825 MHz
		Stopband 1400 MHz Max	1121 MHz
9	Worst Case Spur: (Powered, No RF Input)	-60 dBm Typ	-65.23 dBm
10	Inband Worst Case Spur: (1-18 GHz RF Input)	-60 dBm Typ	-60.54 dBm



TYPICAL CHARACTERISTICS
ON
PRX-20-1G18G-850M-SFF-V2

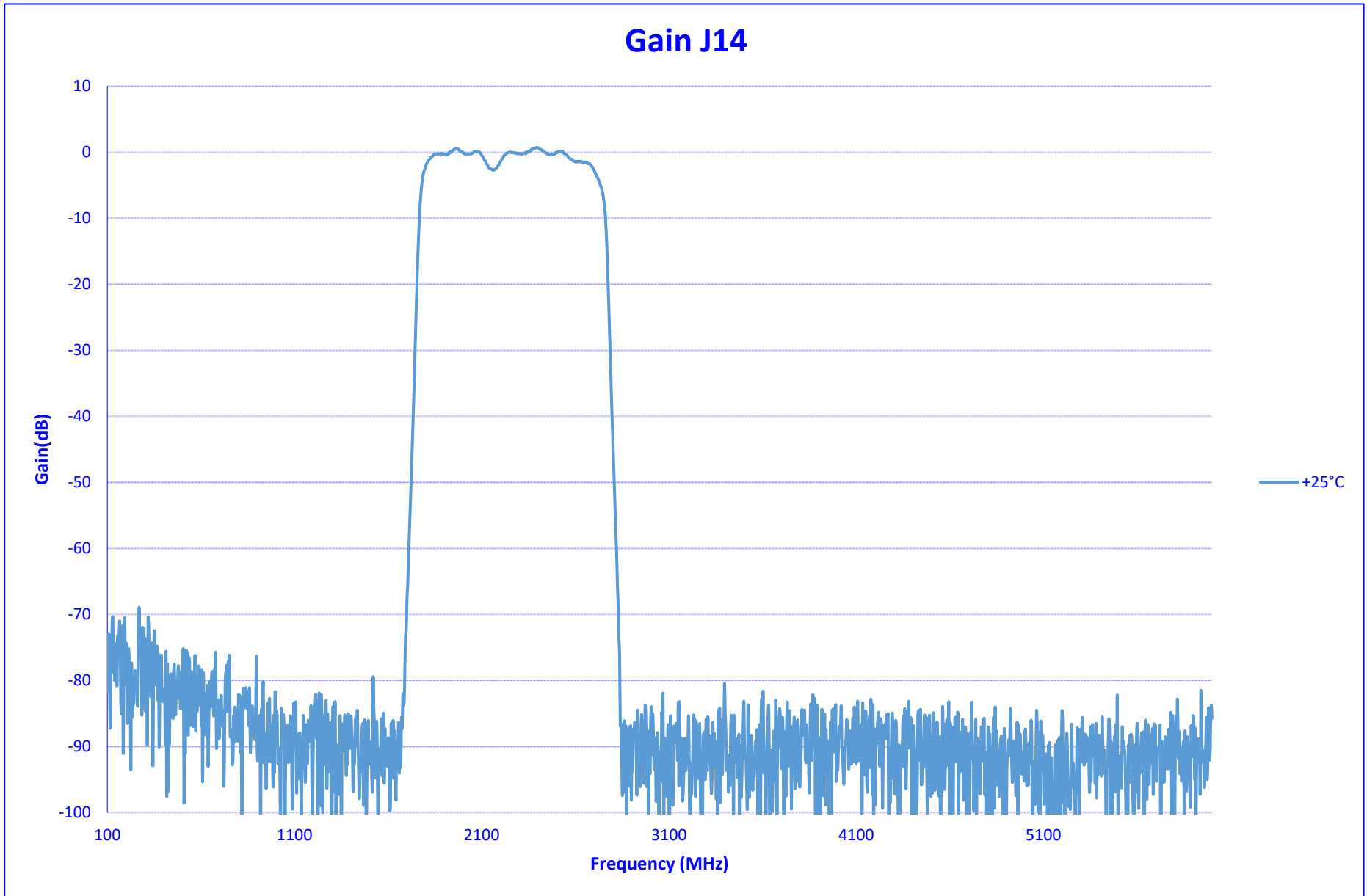



**TYPICAL CHARACTERISTICS
ON
PRX-20-1G18G-850M-SFF-V2**

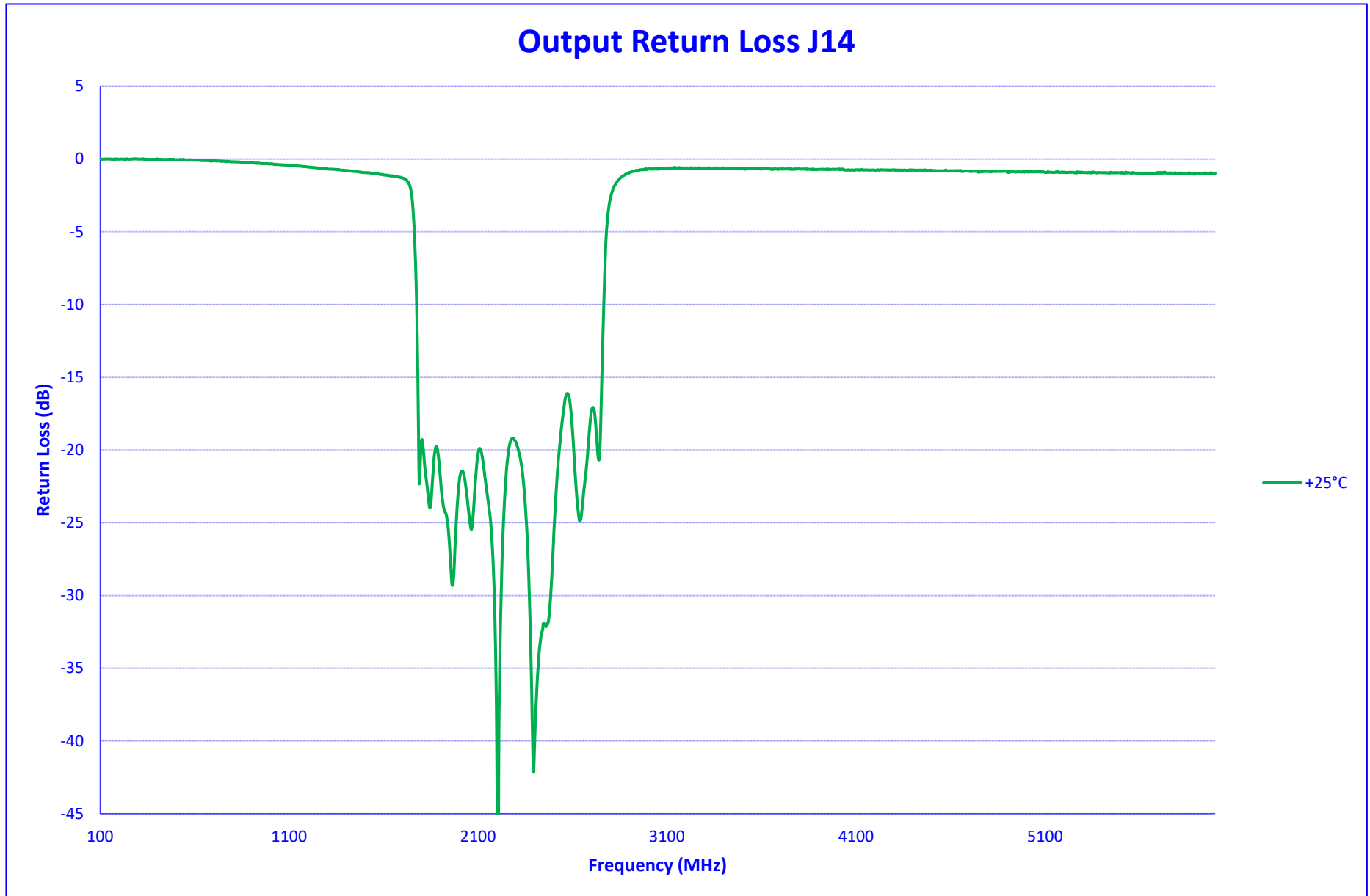



**TYPICAL CHARACTERISTICS
ON
PRX-20-1G18G-850M-SFF-V2**

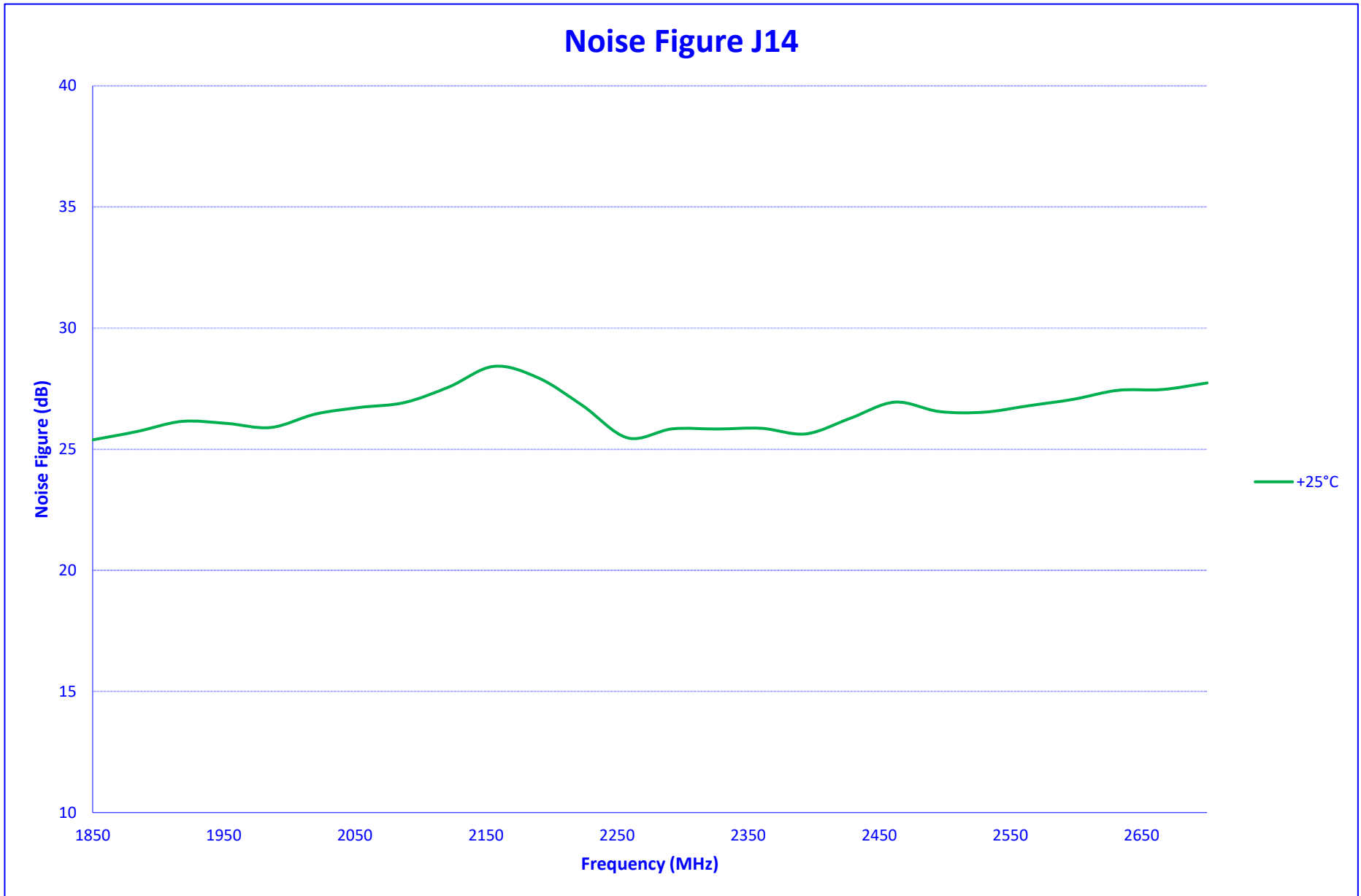



**TYPICAL CHARACTERISTICS
ON
PRX-20-1G18G-850M-SFF-V2**

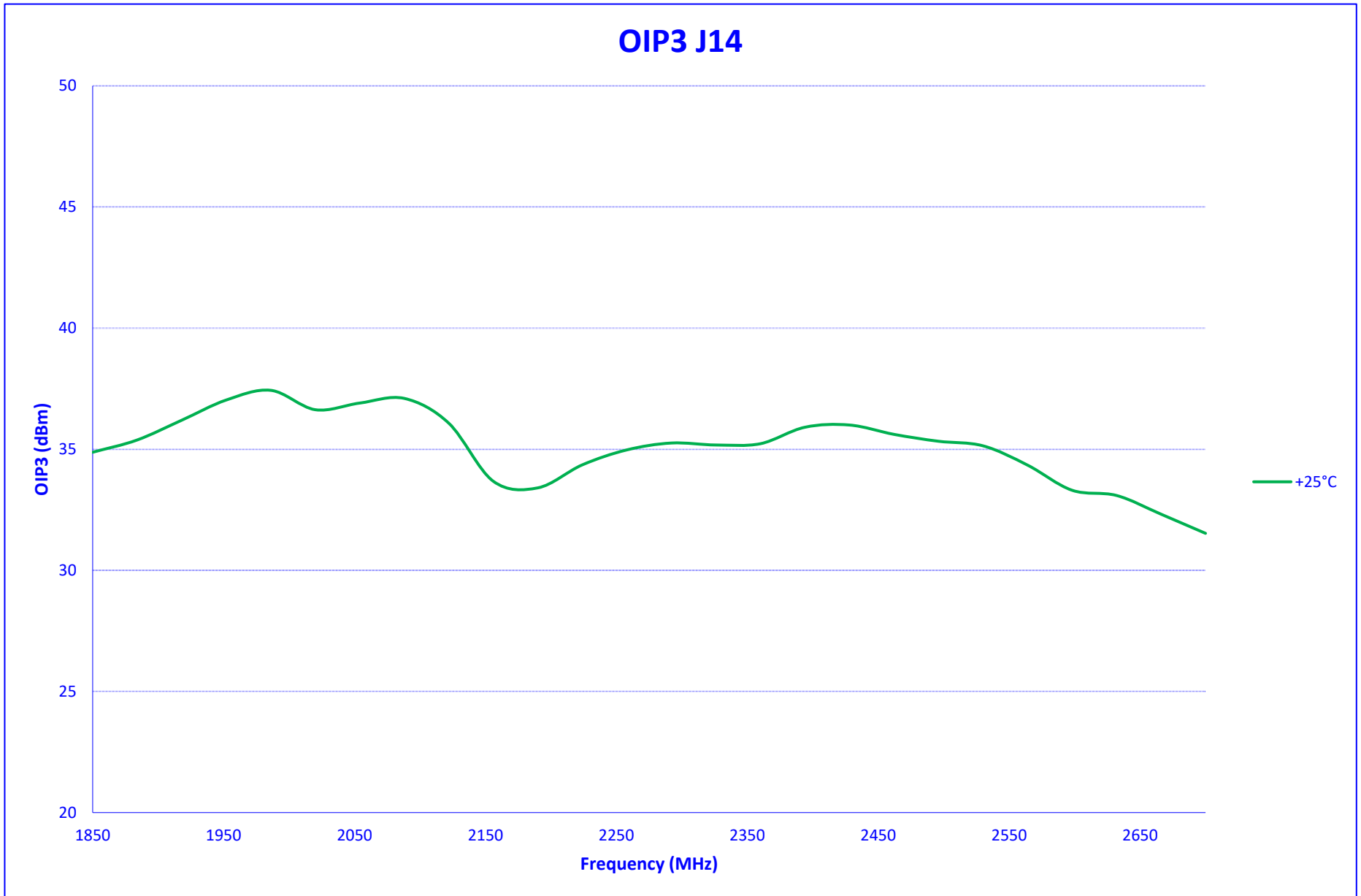



**TYPICAL CHARACTERISTICS
ON
PRX-20-1G18G-850M-SFF-V2**

IN BAND SPURS J14

25°C

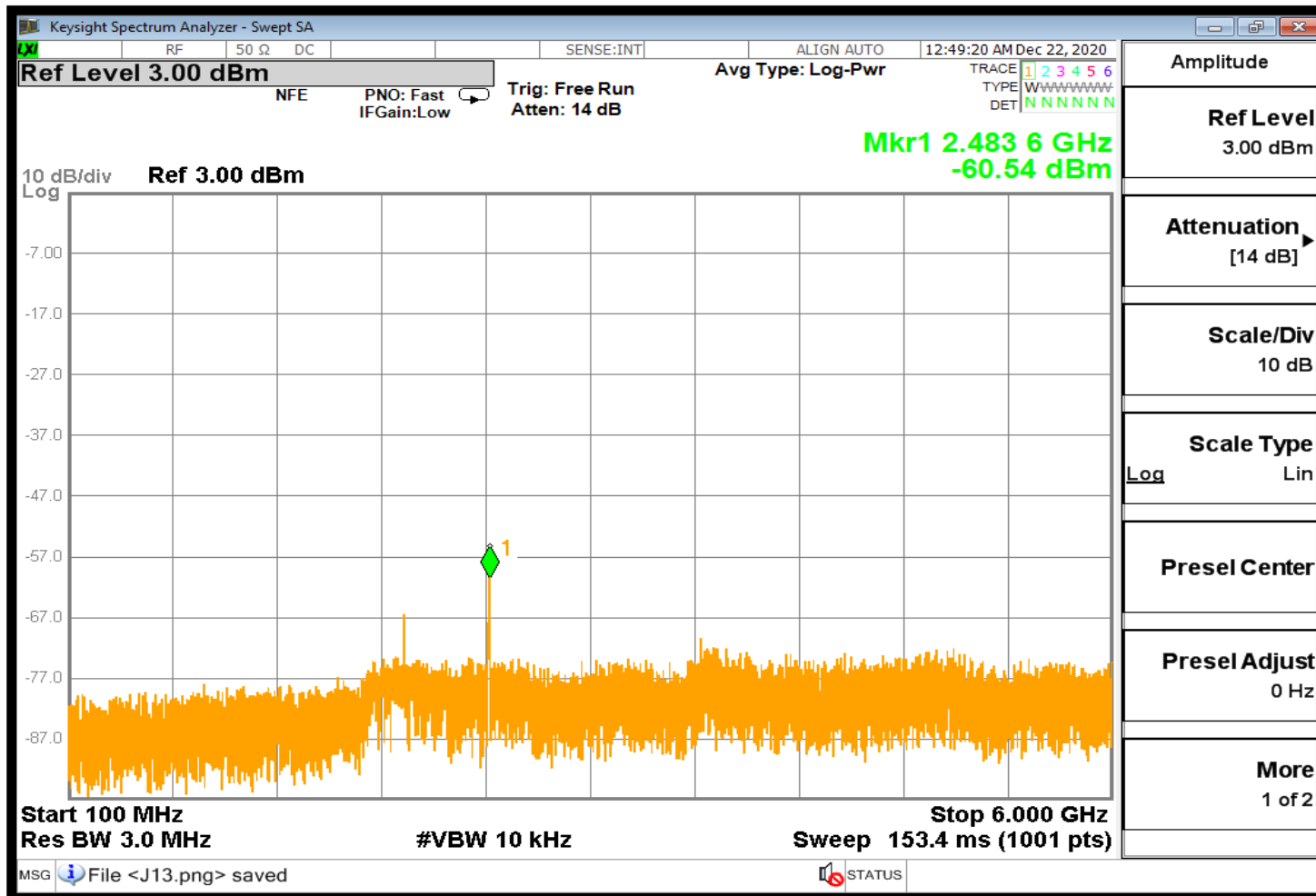



**TYPICAL CHARACTERISTICS
ON
PRX-20-1G18G-850M-SFF-V2**

SUMMARY DATA J15

TEST NO	PARAMETERS	SPECIFIED VALUE	TEST RESULTS
Input Frequency: 12900 - 13750 MHz			+25°C
1	Frequency Range J15:	2700 MHz to 3550 MHz	2700 MHz to 3550 MHz
2	Power Input:	-60 to 0 dBm	-60 to 0 dBm
3	Gain J15:	0 dB ± 3 dB	-0.1 ± 2.2 dB
4	Noise Figure J15:	35 dB Typ	28.99 dB
5	Output IP3 J15:	30 dBm Typ	35.73 dBm
6	Output VSWR J15:	2 : 1 Max	1.4 : 1
7	Passband J15:	Lower 2690 MHz Typ	2667 MHz
		Upper 3560 MHz Typ	3574 MHz
		Passband 870 MHz Typ	907 MHz
8	Stopband J15:	Lower 2485 MHz Typ	2582 MHz
		Upper 3765 MHz Typ	3688 MHz
		Stopband 1400 MHz Max	1106 MHz
9	Worst Case Spur: (Powered, No RF Input)	-60 dBm Typ	-69.06 dBm
10	Inband Worst Case Spur: (1-18 GHz RF Input)	-60 dBm Typ	-60.82 dBm



TYPICAL CHARACTERISTICS
ON
PRX-20-1G18G-850M-SFF-V2

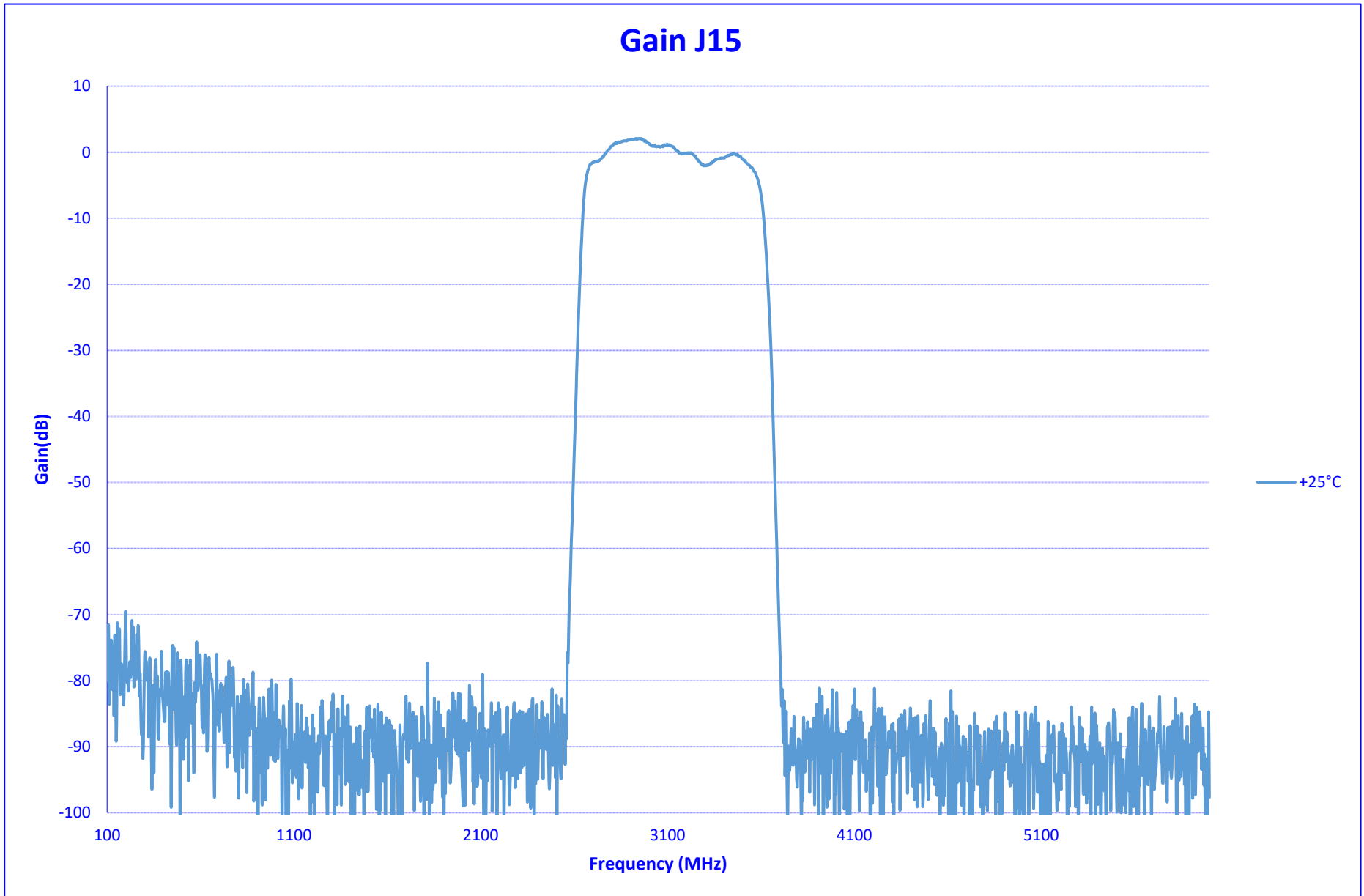



TYPICAL CHARACTERISTICS
ON
PRX-20-1G18G-850M-SFF-V2

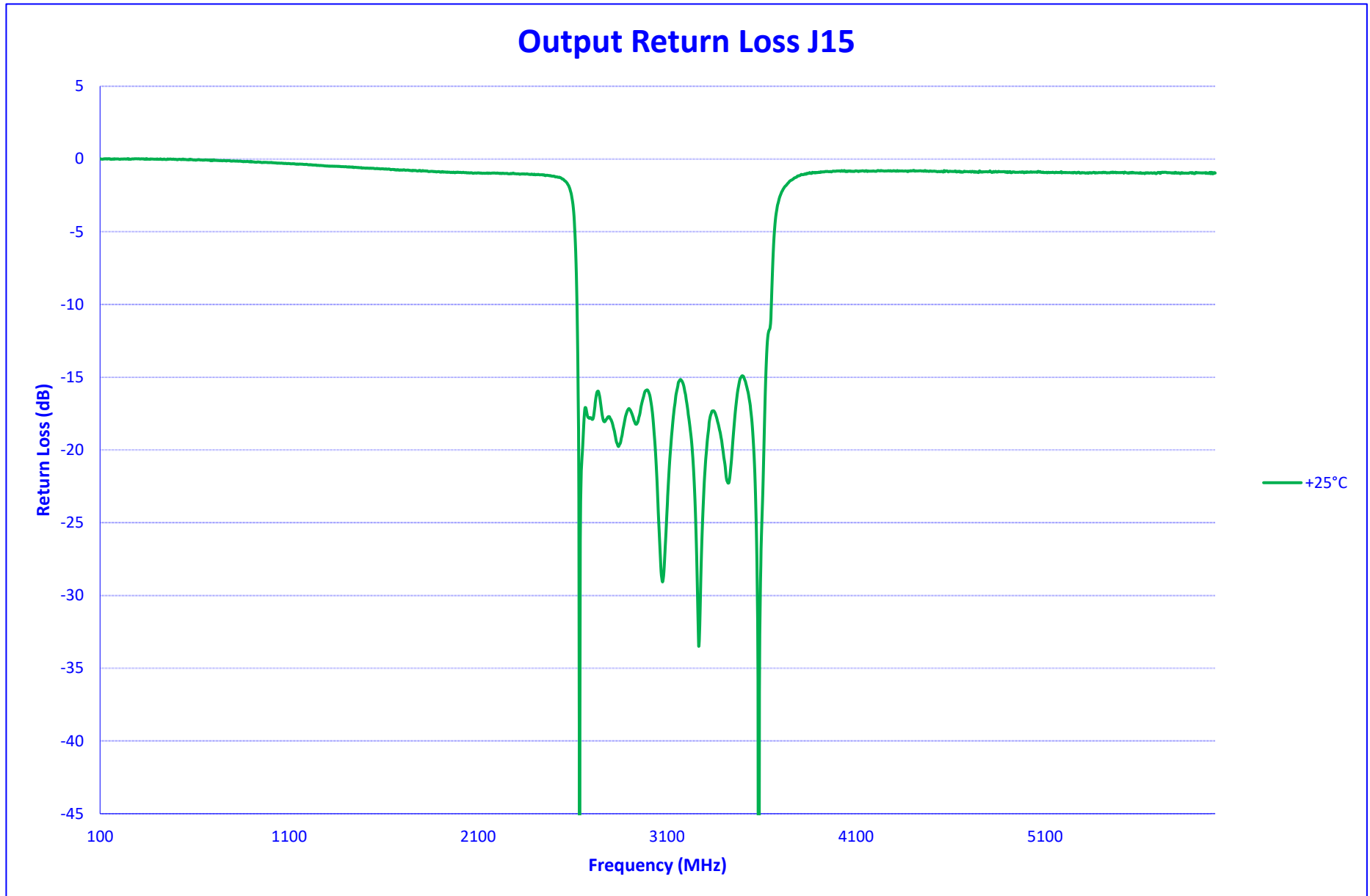



**TYPICAL CHARACTERISTICS
ON
PRX-20-1G18G-850M-SFF-V2**

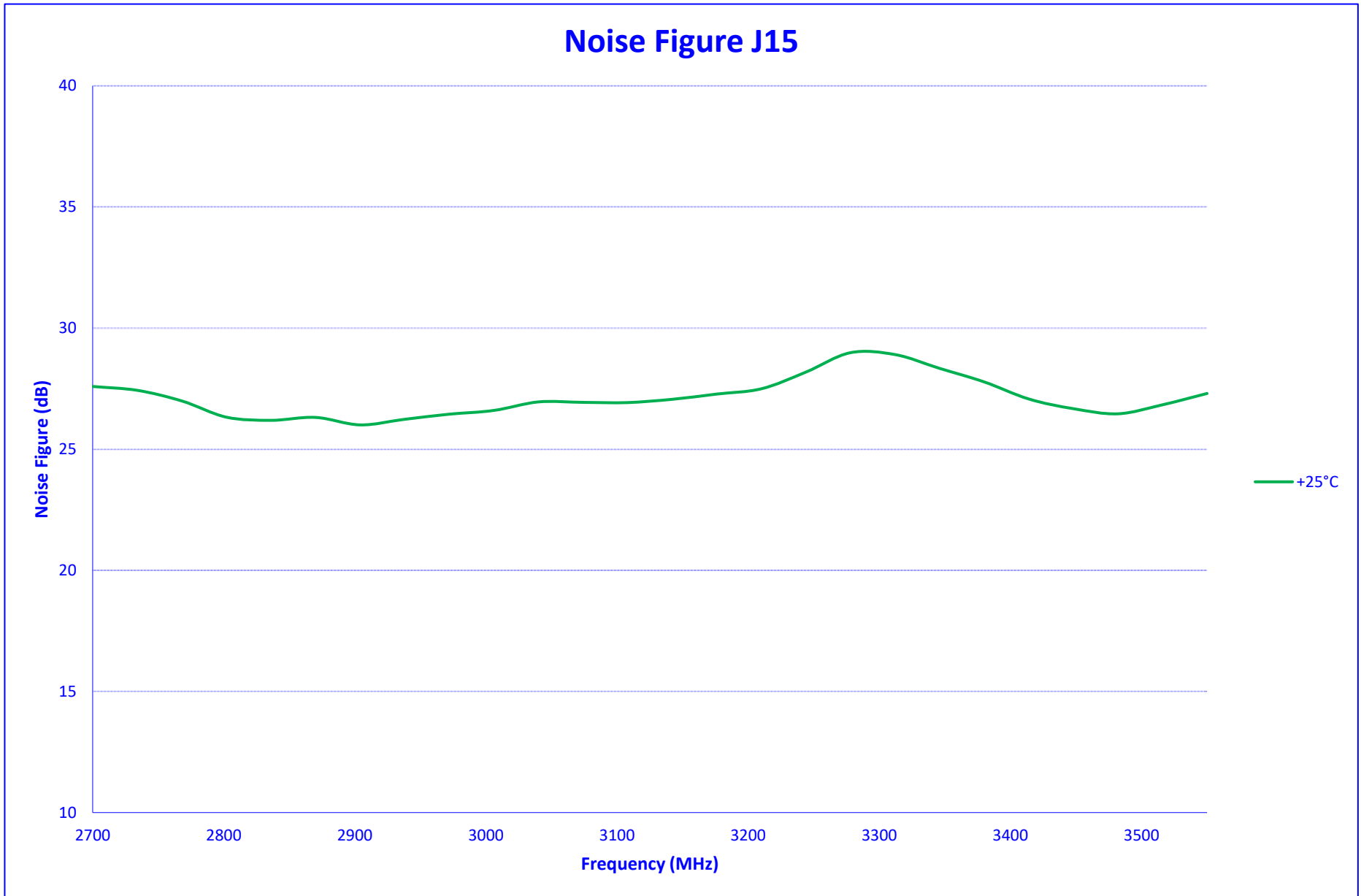



**TYPICAL CHARACTERISTICS
ON
PRX-20-1G18G-850M-SFF-V2**

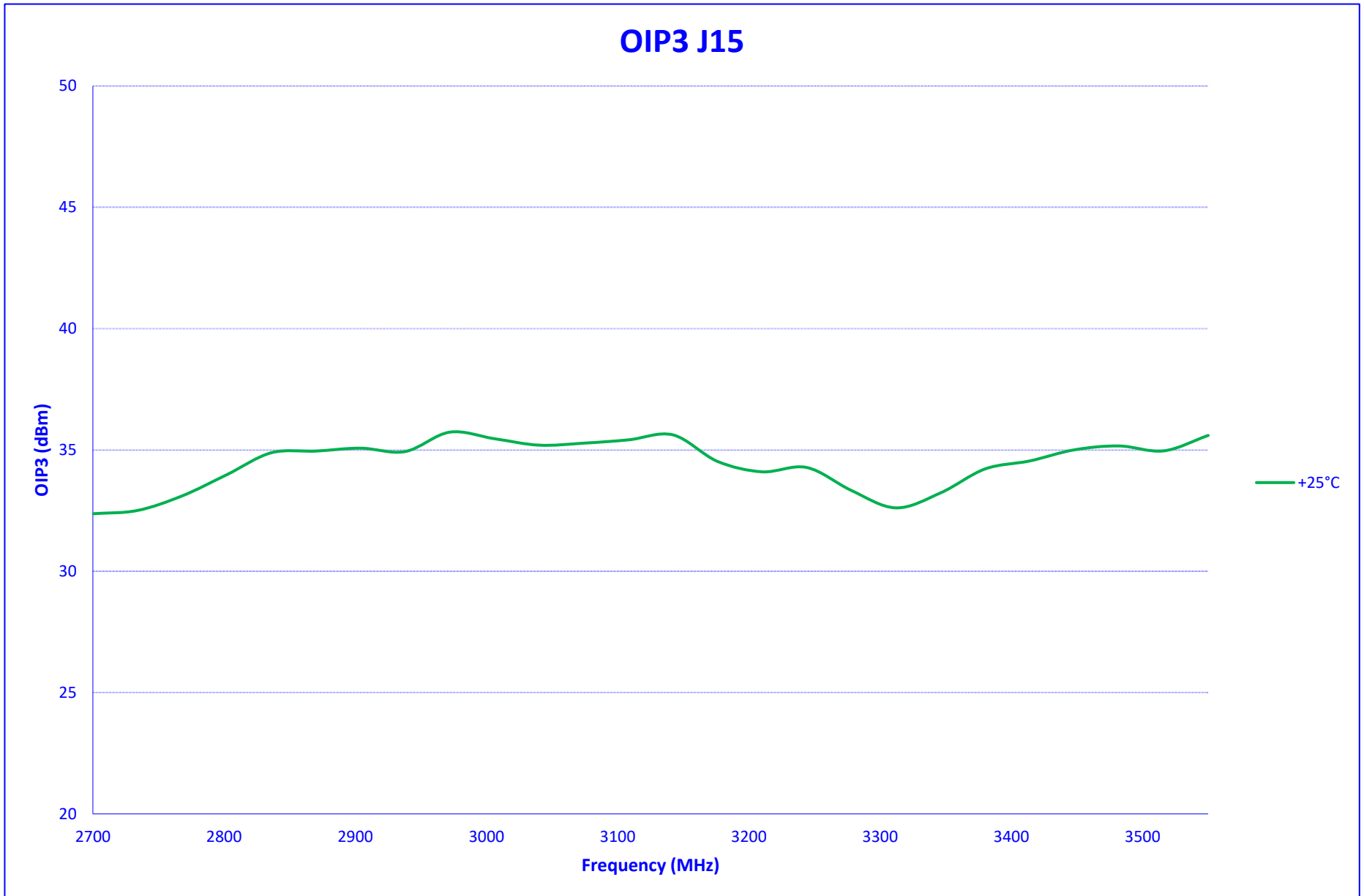



TYPICAL CHARACTERISTICS
ON
PRX-20-1G18G-850M-SFF-V2

IN BAND SPURS J15

25°C

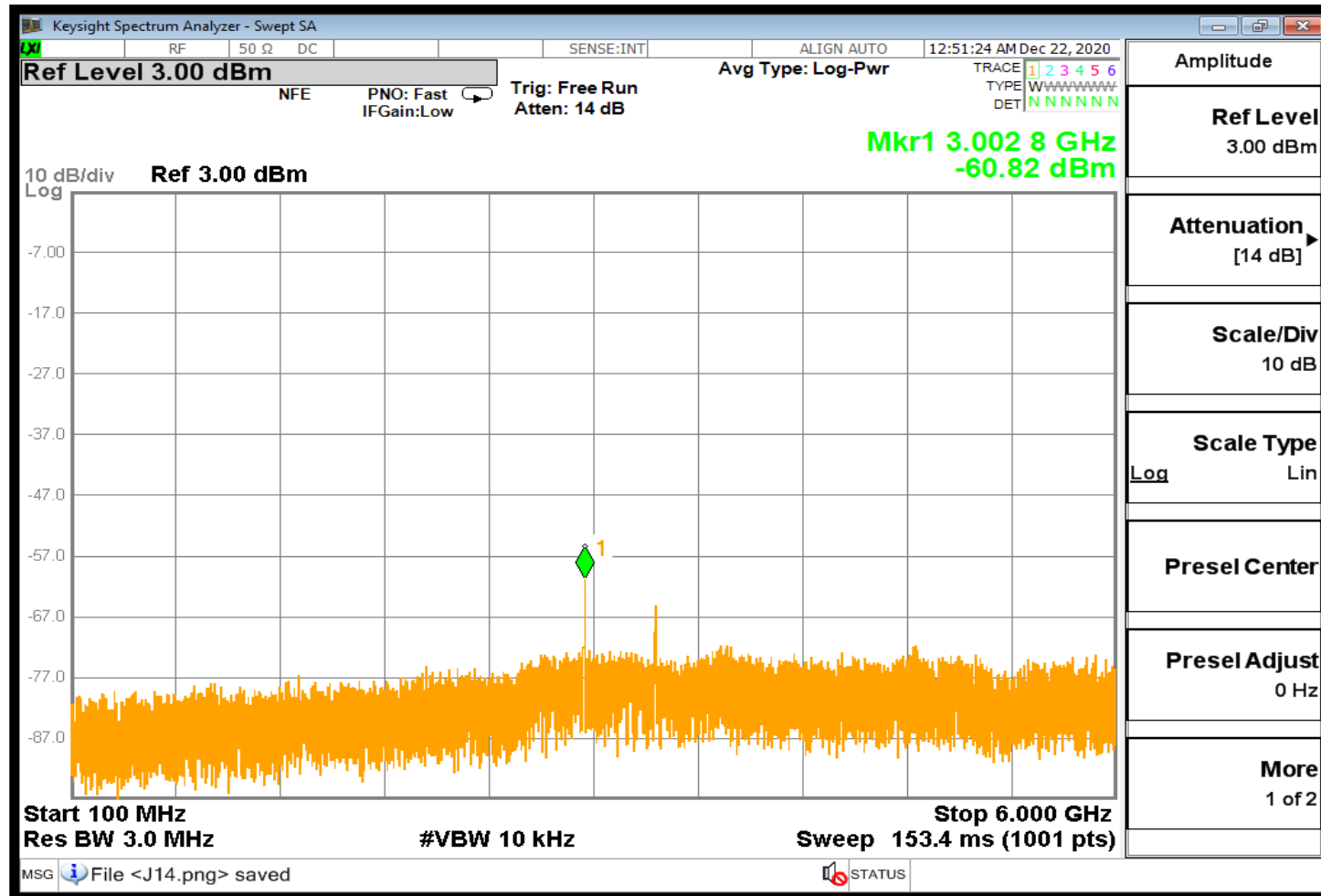



**TYPICAL CHARACTERISTICS
ON
PRX-20-1G18G-850M-SFF-V2**

SUMMARY DATA J16

TEST NO	PARAMETERS	SPECIFIED VALUE	TEST RESULTS
Input Frequency: 13750 - 14600 MHz			+25°C
1	Frequency Range J16:	3550 MHz to 4400 MHz	3550 MHz to 4400 MHz
2	Power Input:	-60 to 0 dBm	-60 to 0 dBm
3	Gain J16:	0 dB ± 3 dB	-0.6 ± 1.4 dB
4	Noise Figure J16:	35 dB Typ	30.34 dB
5	Output IP3 J16:	30 dBm Typ	33.06 dBm
6	Output VSWR J16:	2 : 1 Max	1.6 : 1
7	Passband J16:	Lower 3540 MHz Typ	3496 MHz
		Upper 4410 MHz Typ	4440 MHz
		Passband 870 MHz Typ	944 MHz
8	Stopband J16:	Lower 3275MHz Typ	3382 MHz
		Upper 4675 MHz Typ	4573 MHz
		Stopband 1400 MHz Max	1191 MHz
9	Worst Case Spur: (Powered, No RF Input)	-60 dBm Typ	-65.53 dBm
10	Inband Worst Case Spur: (1-18 GHz RF Input)	-60 dBm Typ	-58.68 dBm



**TYPICAL CHARACTERISTICS
ON
PRX-20-1G18G-850M-SFF-V2**

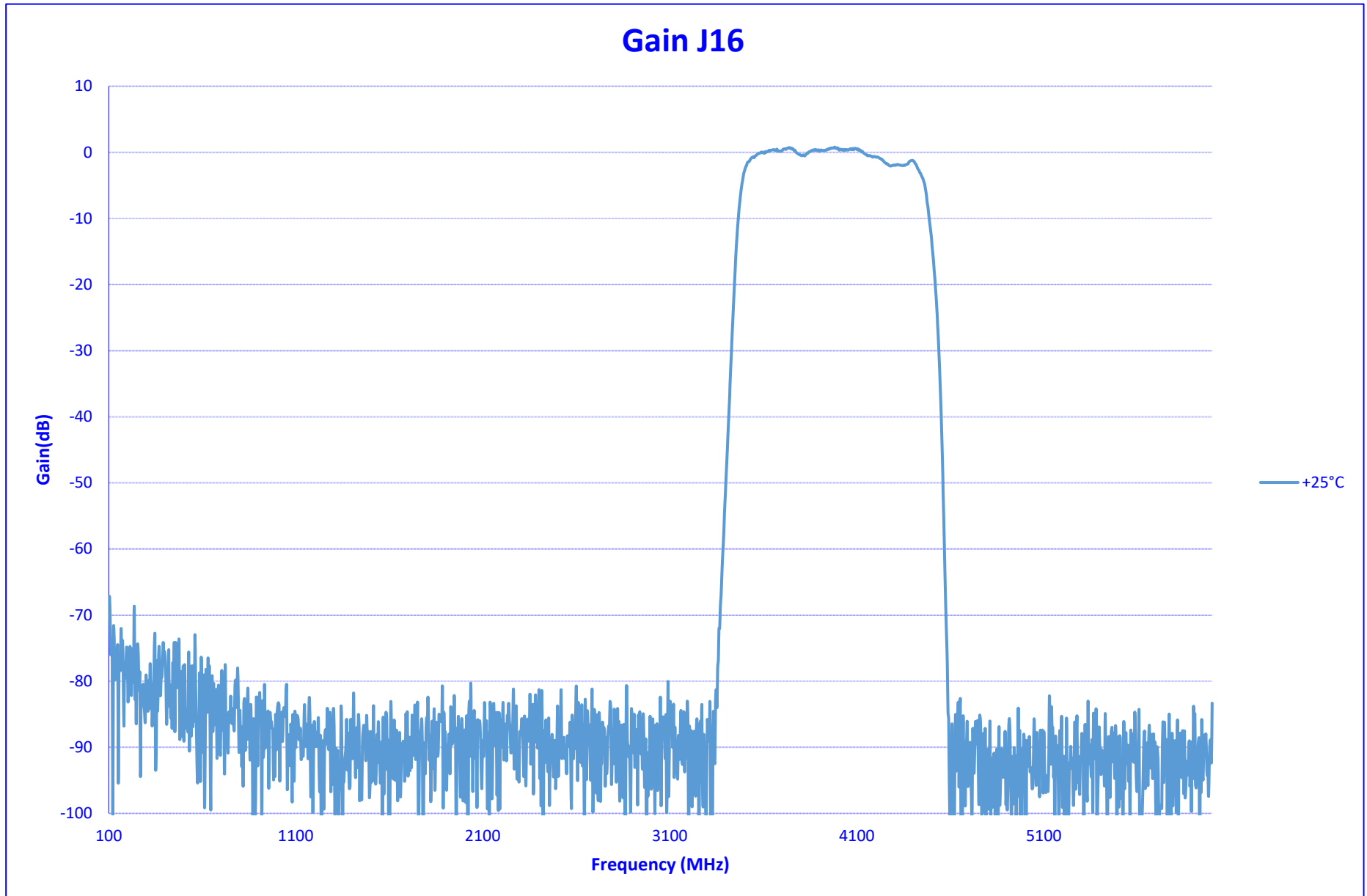



**TYPICAL CHARACTERISTICS
ON
PRX-20-1G18G-850M-SFF-V2**

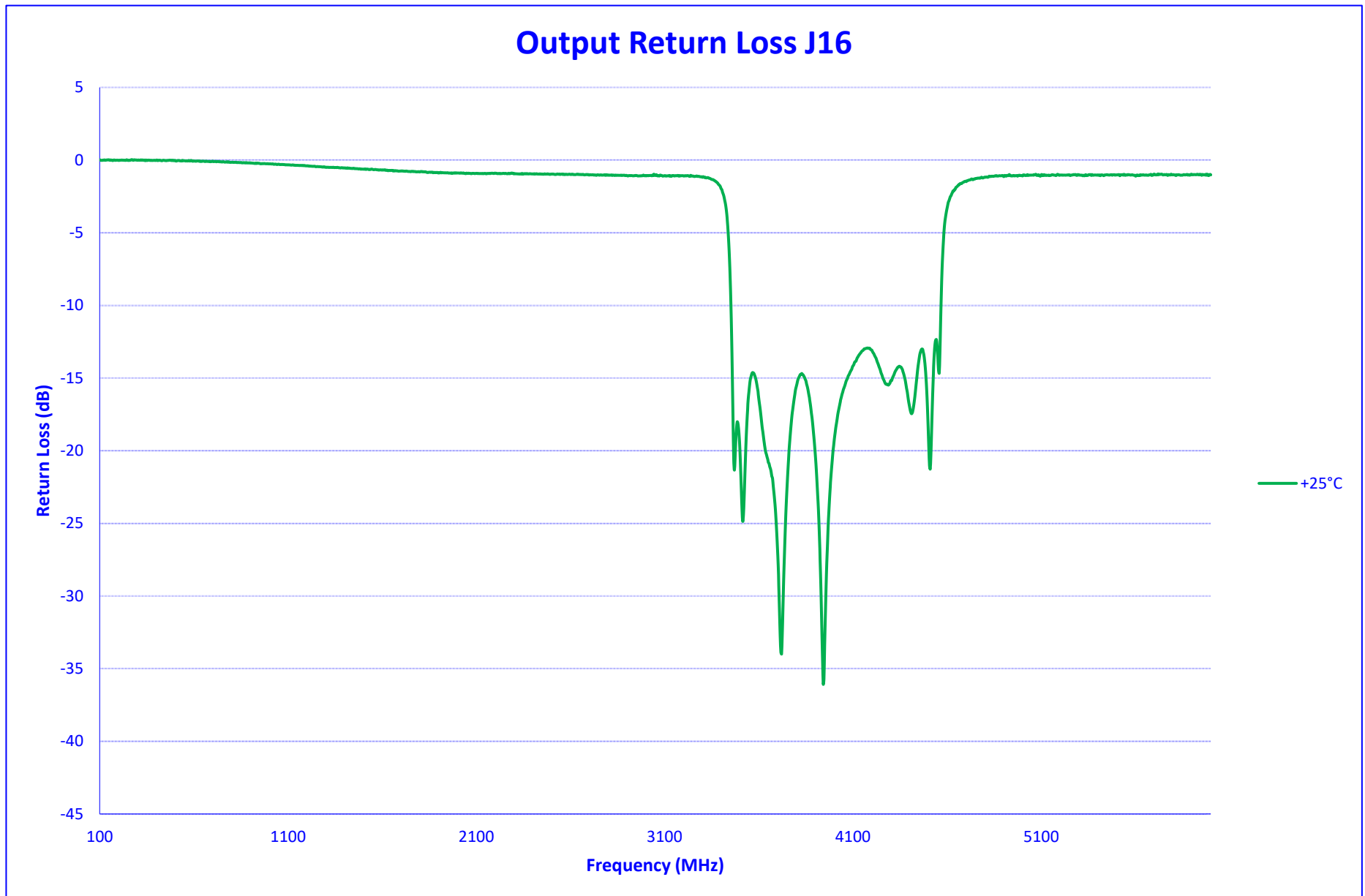



**TYPICAL CHARACTERISTICS
ON
PRX-20-1G18G-850M-SFF-V2**

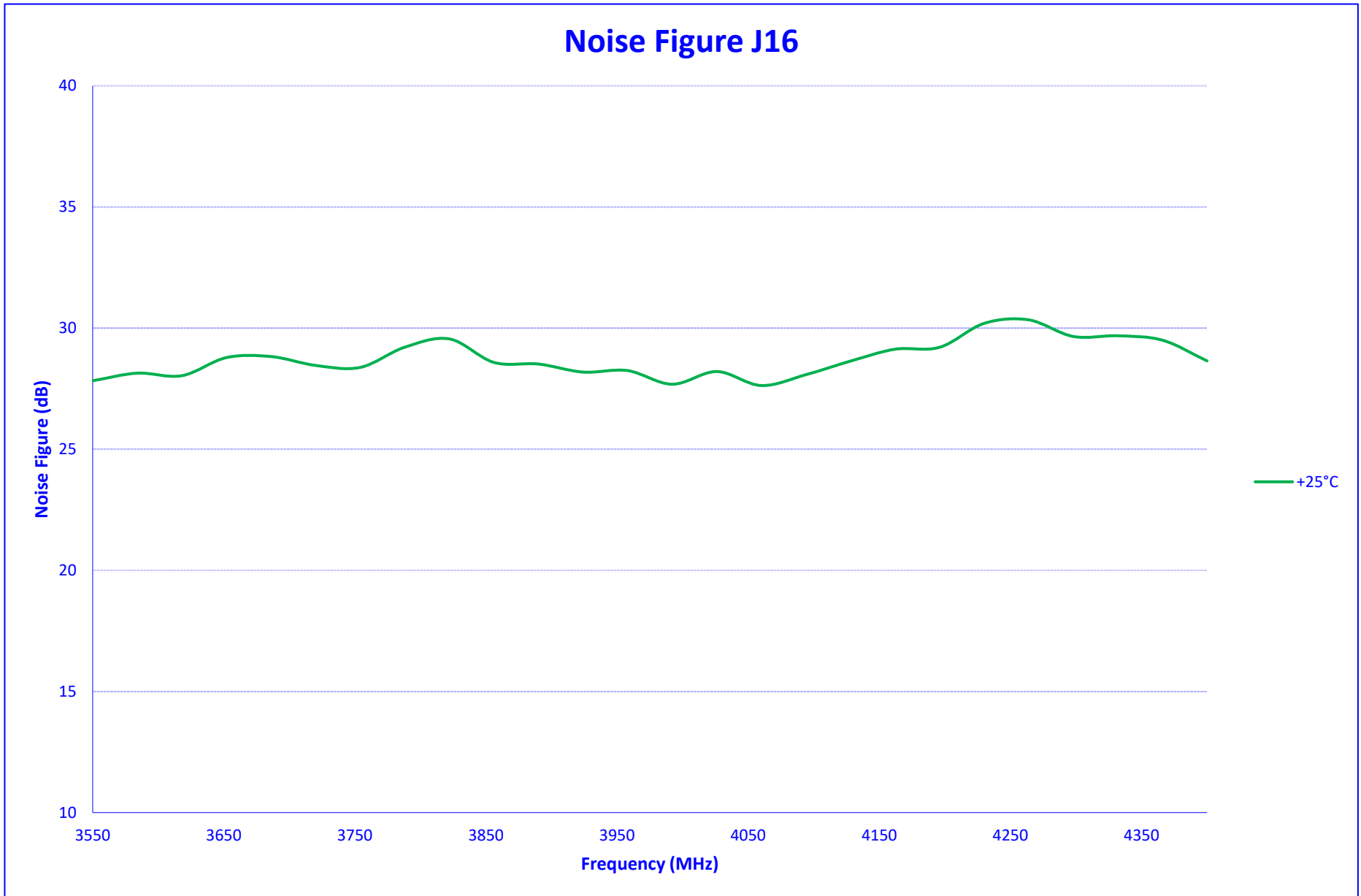



**TYPICAL CHARACTERISTICS
ON
PRX-20-1G18G-850M-SFF-V2**

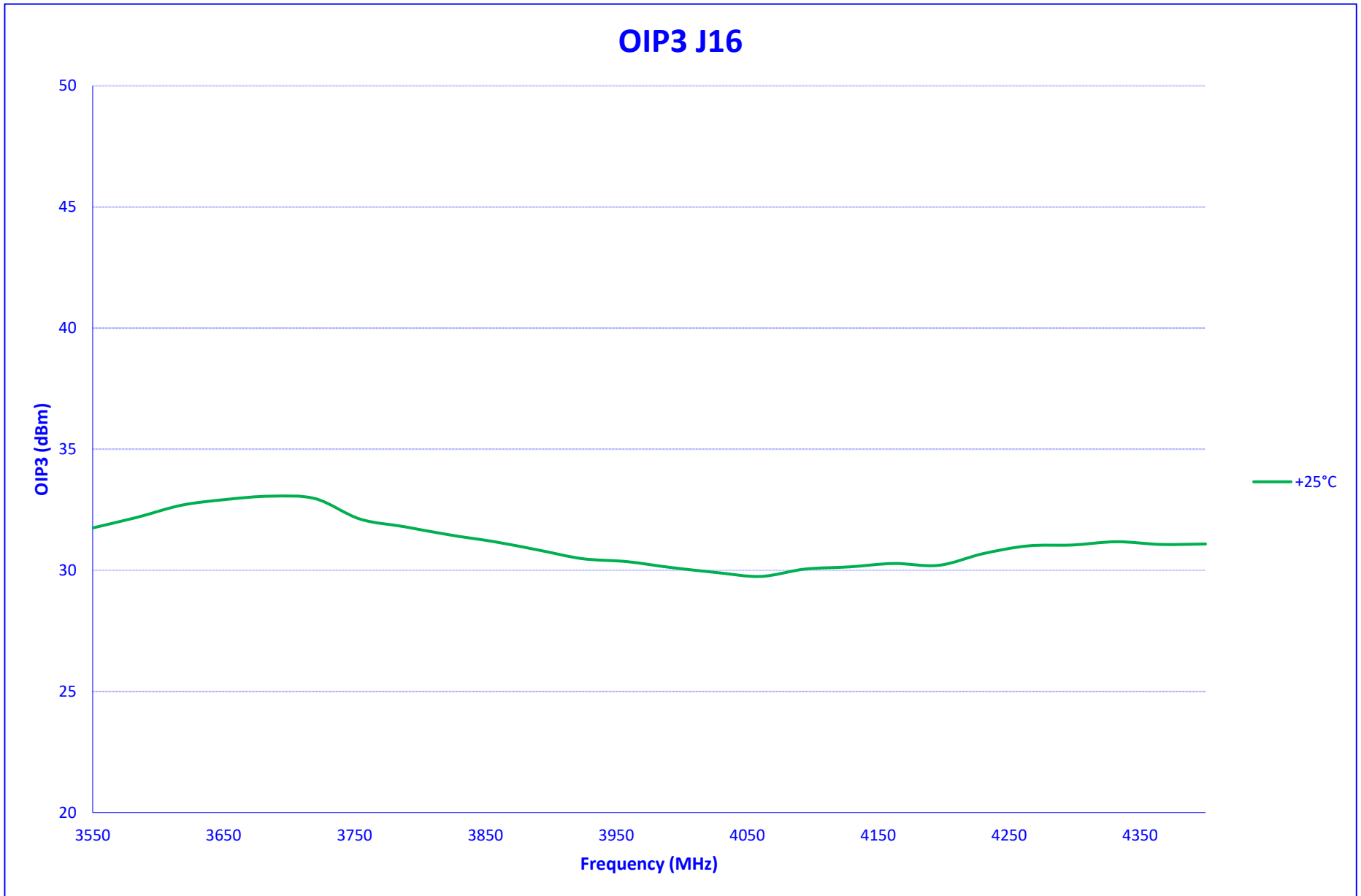



**TYPICAL CHARACTERISTICS
ON
PRX-20-1G18G-850M-SFF-V2**

IN BAND SPURS J16

25°C

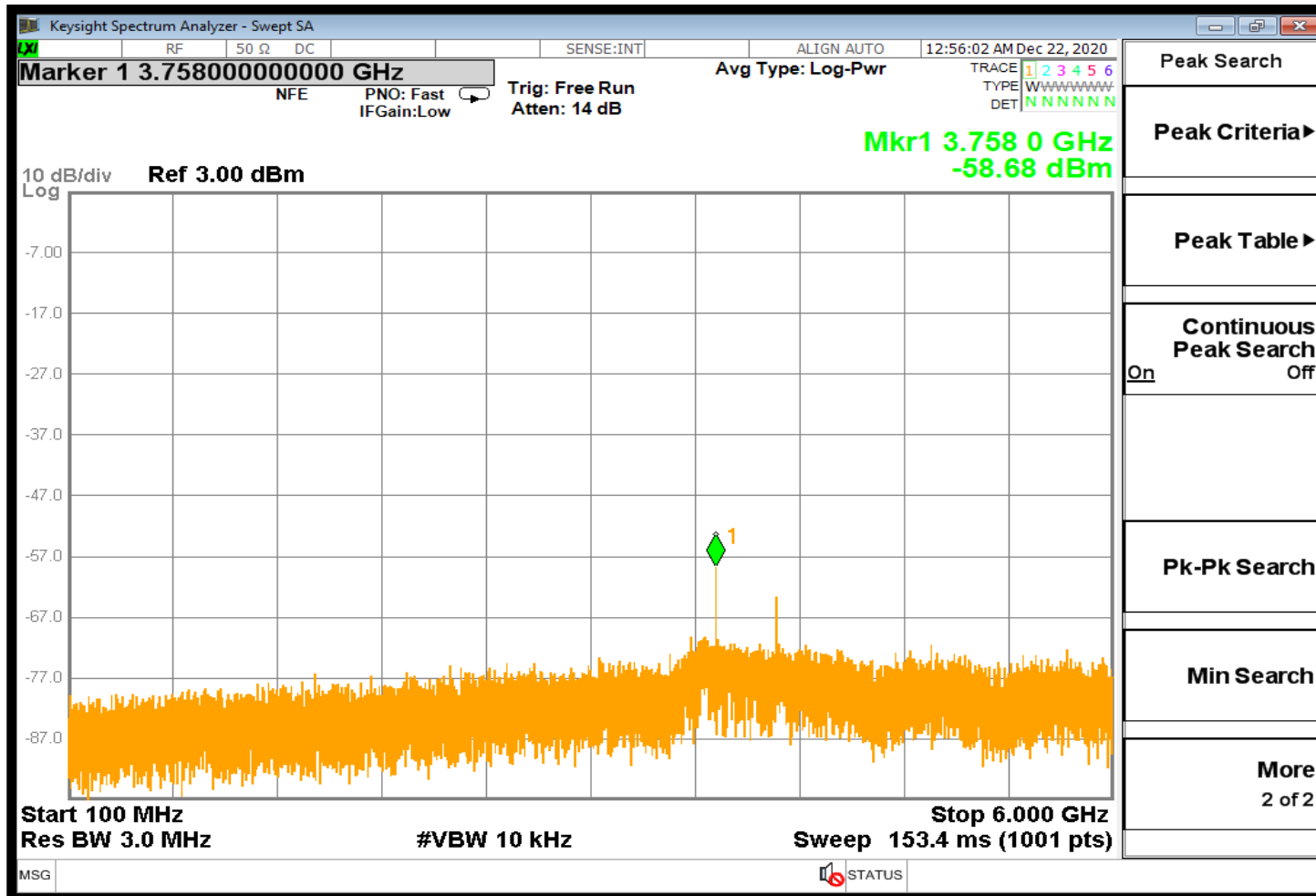



**TYPICAL CHARACTERISTICS
ON
PRX-20-1G18G-850M-SFF-V2**

SUMMARY DATA J17

TEST NO	PARAMETERS	SPECIFIED VALUE	TEST RESULTS
Input Frequency: 14600 - 15450 MHz			+25°C
1	Frequency Range J17:	1000 MHz to 1850 MHz	1000 MHz to 1850 MHz
2	Power Input:	-60 to 0 dBm	-60 to 0 dBm
3	Gain J17:	0 dB ± 3 dB	-0.2 ± 1.9 dB
4	Noise Figure J17:	38 dB Typ	29.9 dB
5	Output IP3 J17:	30 dBm Typ	37.63 dBm
6	Output VSWR J17:	2 : 1 Max	1.6 : 1
7	Passband J17:	Lower 990 MHz Typ	981 MHz
		Upper 1860 MHz Typ	1863 MHz
		Passband 870 MHz Typ	881 MHz
8	Stopband J17:	Lower 890 MHz Typ	933 MHz
		Upper 1980 MHz Typ	1940 MHz
		Stopband 1400 MHz Max	1007 MHz
9	Worst Case Spur: (Powered, No RF Input)	-60 dBm Typ	-71.64 dBm
10	Inband Worst Case Spur: (1-18 GHz RF Input)	-60 dBm Typ	None



**TYPICAL CHARACTERISTICS
ON
PRX-20-1G18G-850M-SFF-V2**

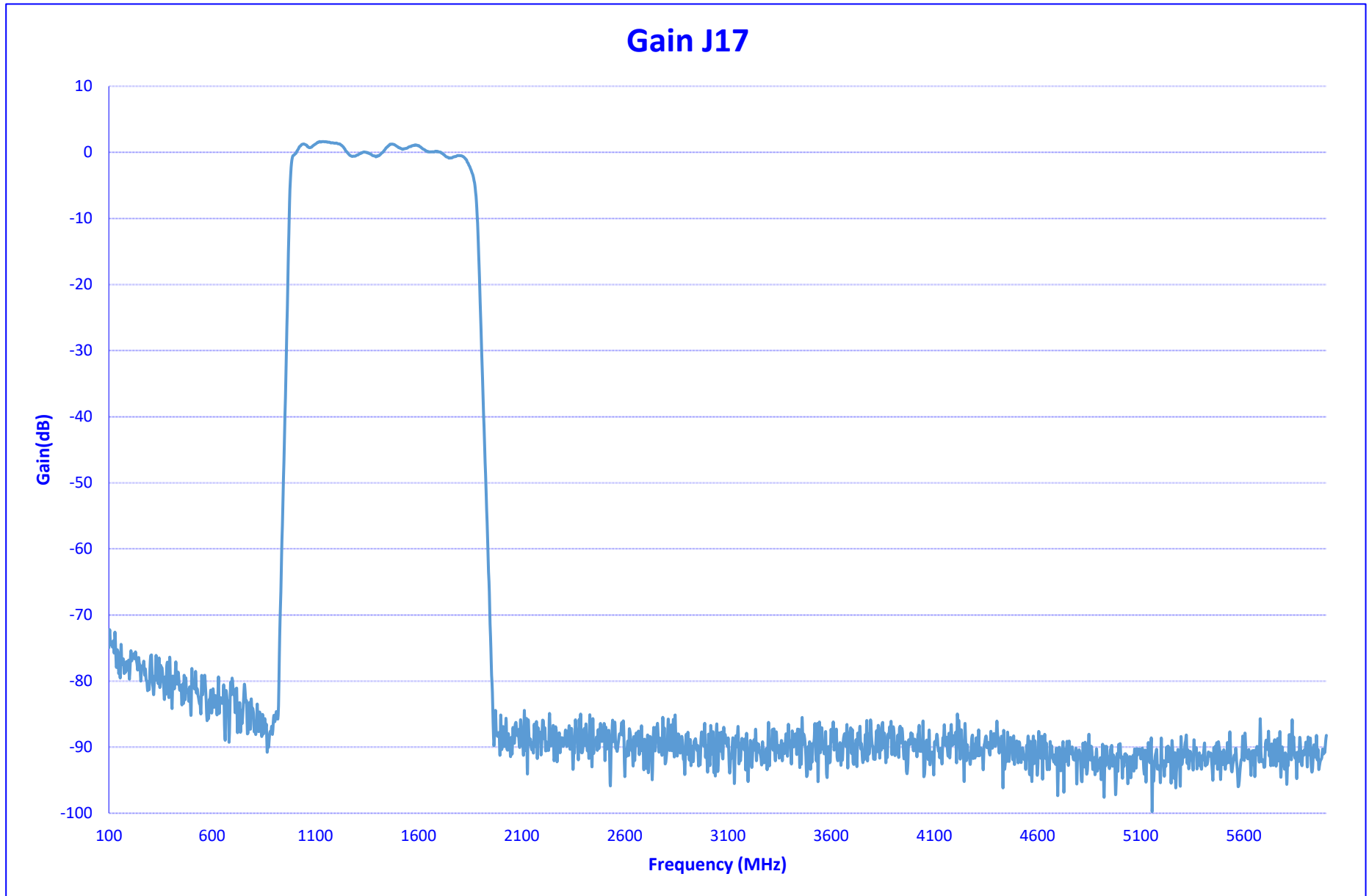



**TYPICAL CHARACTERISTICS
ON
PRX-20-1G18G-850M-SFF-V2**

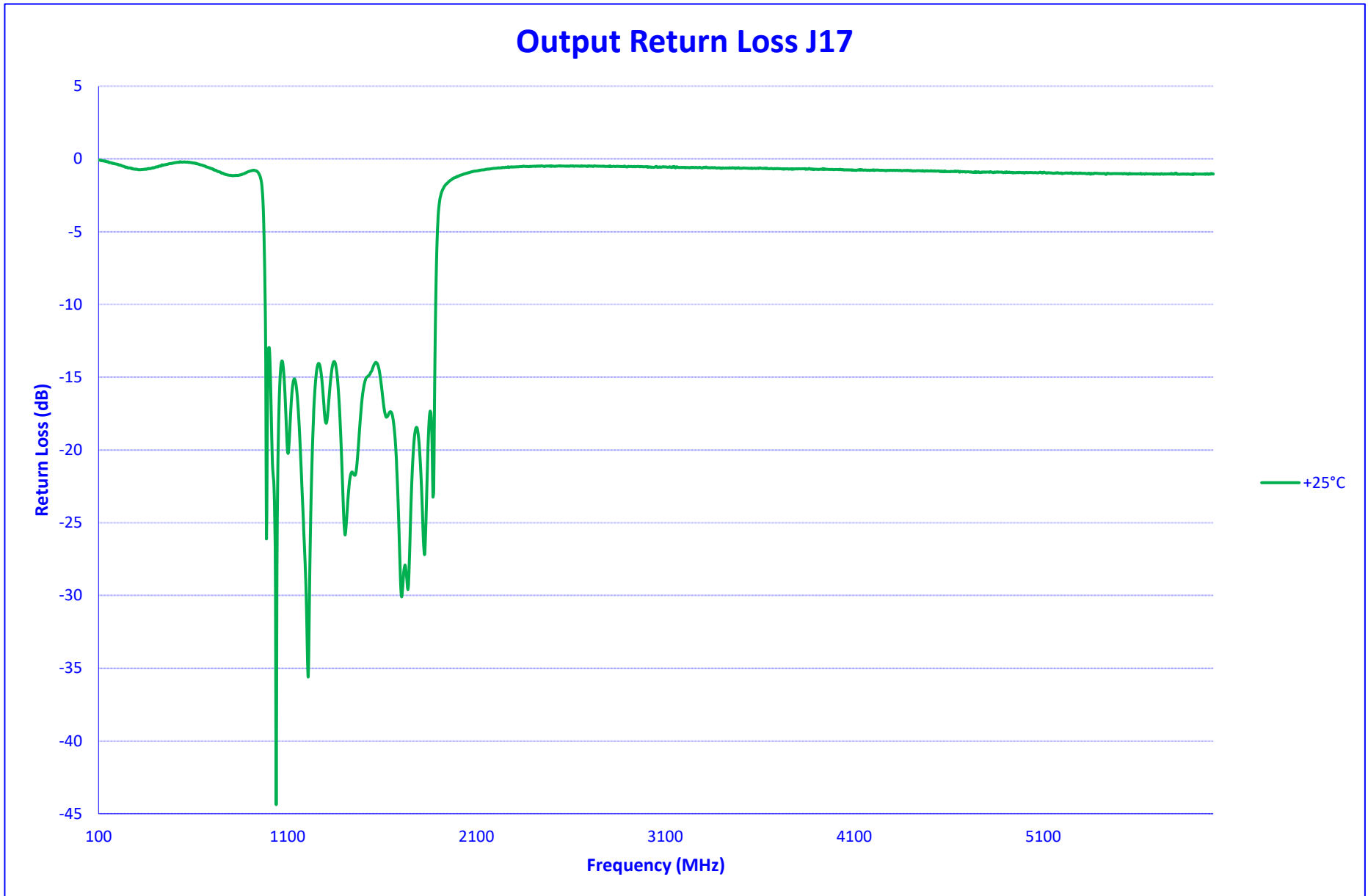



**TYPICAL CHARACTERISTICS
ON
PRX-20-1G18G-850M-SFF-V2**

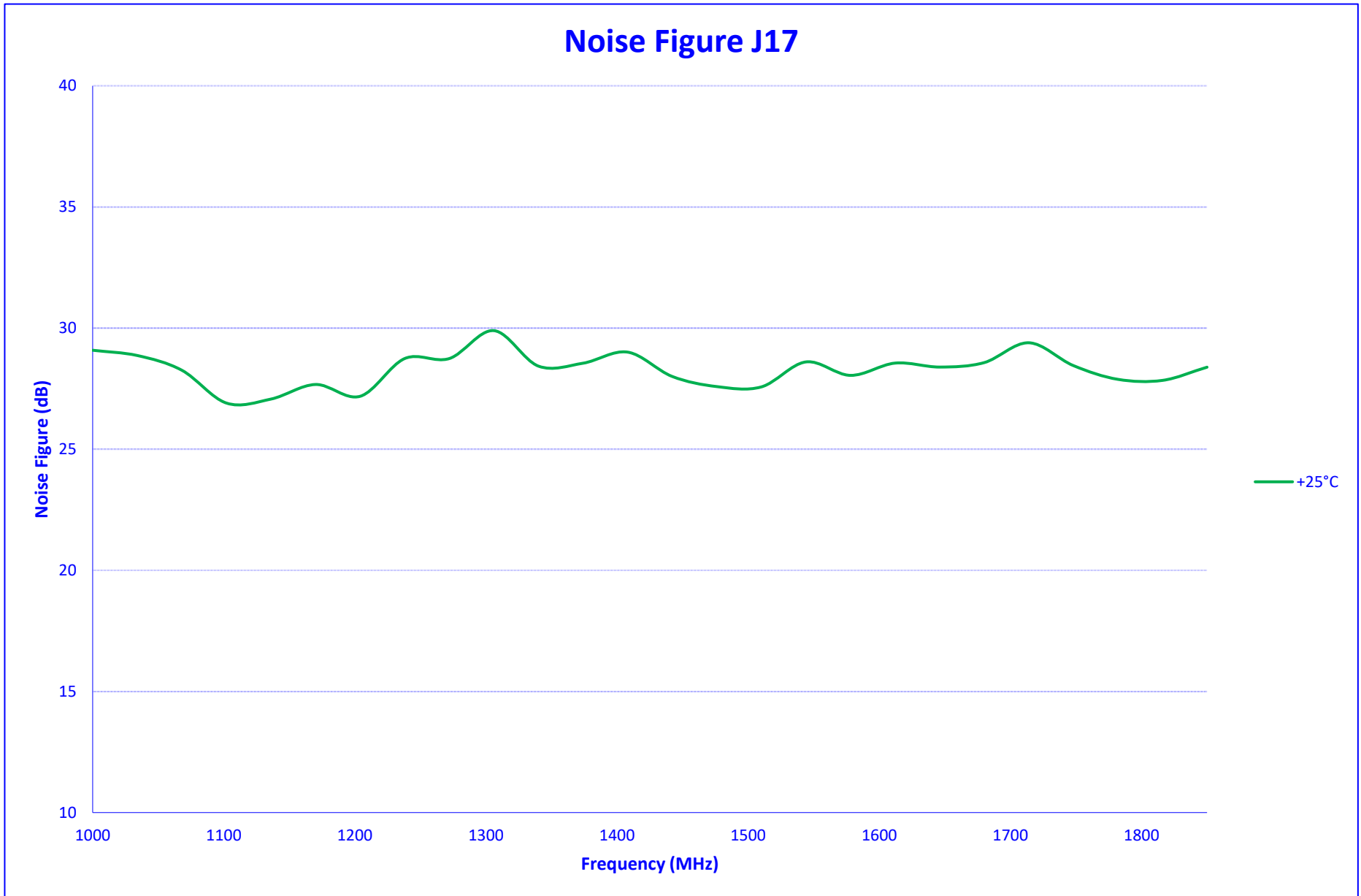



TYPICAL CHARACTERISTICS
ON
PRX-20-1G18G-850M-SFF-V2

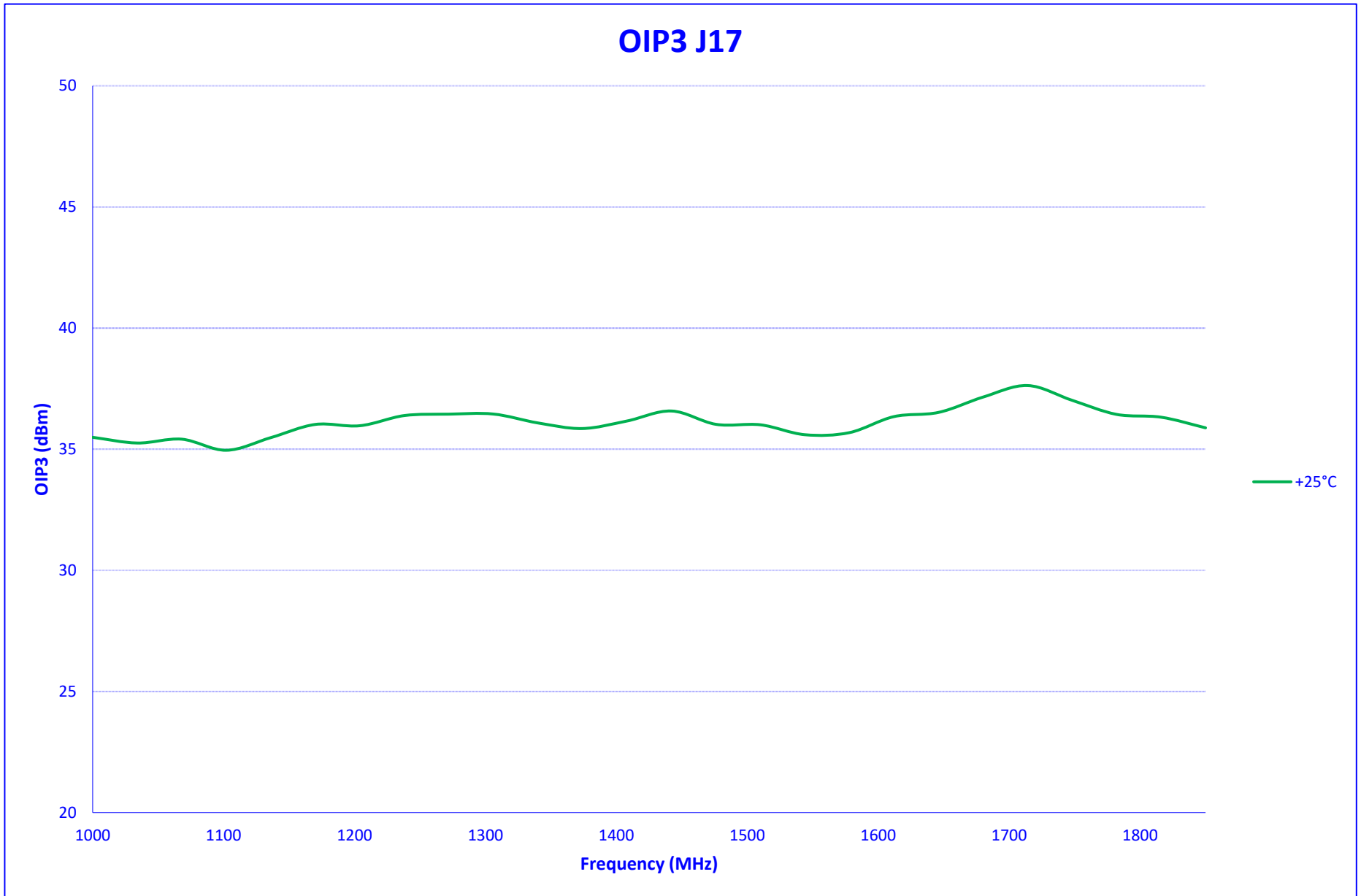



TYPICAL CHARACTERISTICS
ON
PRX-20-1G18G-850M-SFF-V2

IN BAND SPURS J17

25°C

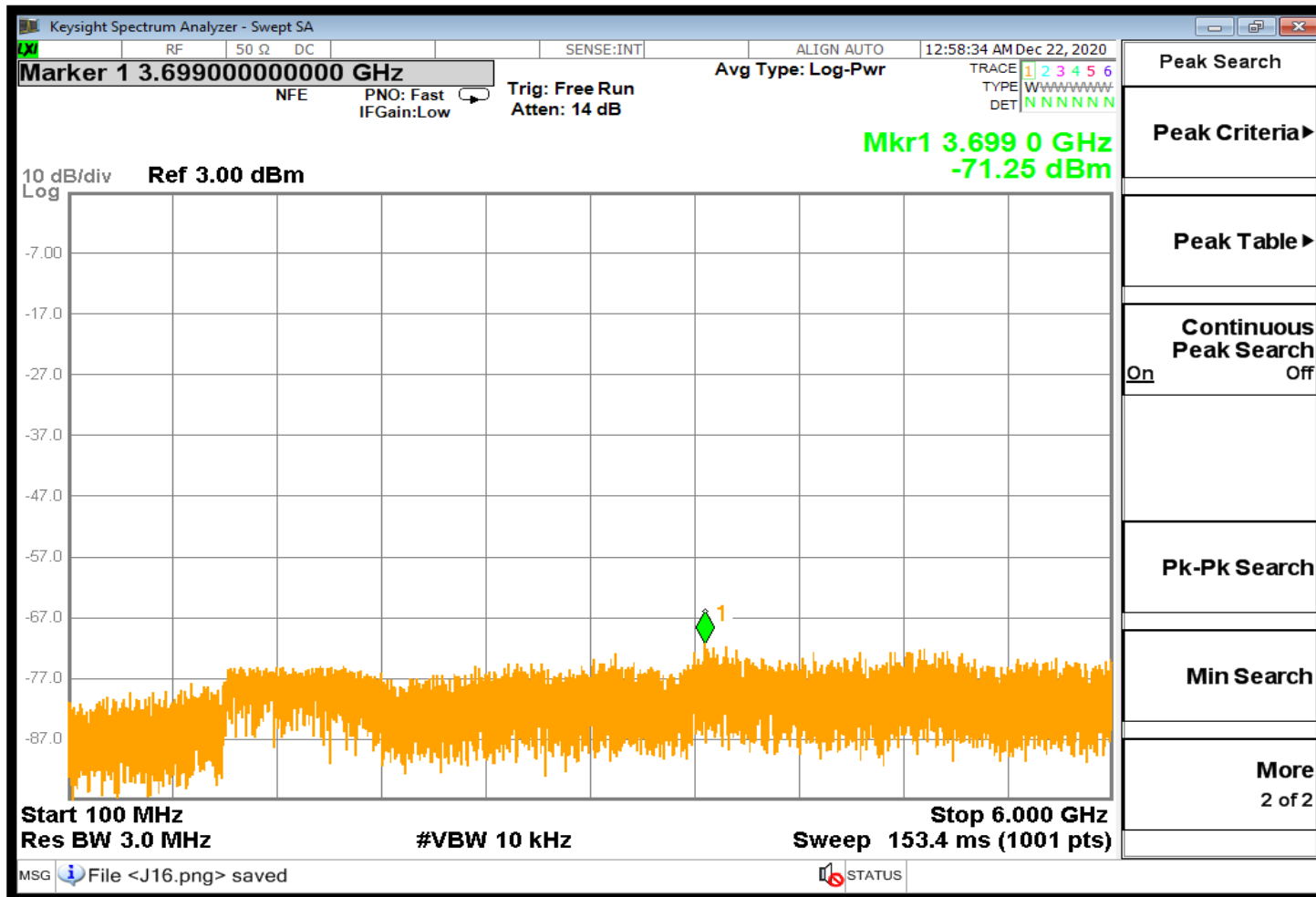



**TYPICAL CHARACTERISTICS
ON
PRX-20-1G18G-850M-SFF-V2**

SUMMARY DATA J18

TEST NO	PARAMETERS	SPECIFIED VALUE	TEST RESULTS
Input Frequency: 15450 - 16300 MHz			+25°C
1	Frequency Range J18:	1850 MHz to 2700 MHz	1850 MHz to 2700 MHz
2	Power Input:	-60 to 0 dBm	-60 to 0 dBm
3	Gain J18:	0 dB ± 3 dB	-0.4 ± 1.1 dB
4	Noise Figure J18:	38 dB Typ	28.67 dB
5	Output IP3 J18:	30 dBm Typ	36.39 dBm
6	Output VSWR J18:	2 : 1 Max	1.3 : 1
7	Passband J18:	Lower 1840 MHz Typ	1804 MHz
		Upper 2710 MHz Typ	2744 MHz
		Passband 870 MHz Typ	940 MHz
8	Stopband J18:	Lower 1635 MHz Typ	1708 MHz
		Upper 2915 MHz Typ	2825 MHz
		Stopband 1400 MHz Max	1117 MHz
9	Worst Case Spur: (Powered, No RF Input)	-60 dBm Typ	-71.61 dBm
10	Inband Worst Case Spur: (1-18 GHz RF Input)	-60 dBm Typ	-69.06 dBm



**TYPICAL CHARACTERISTICS
ON
PRX-20-1G18G-850M-SFF-V2**

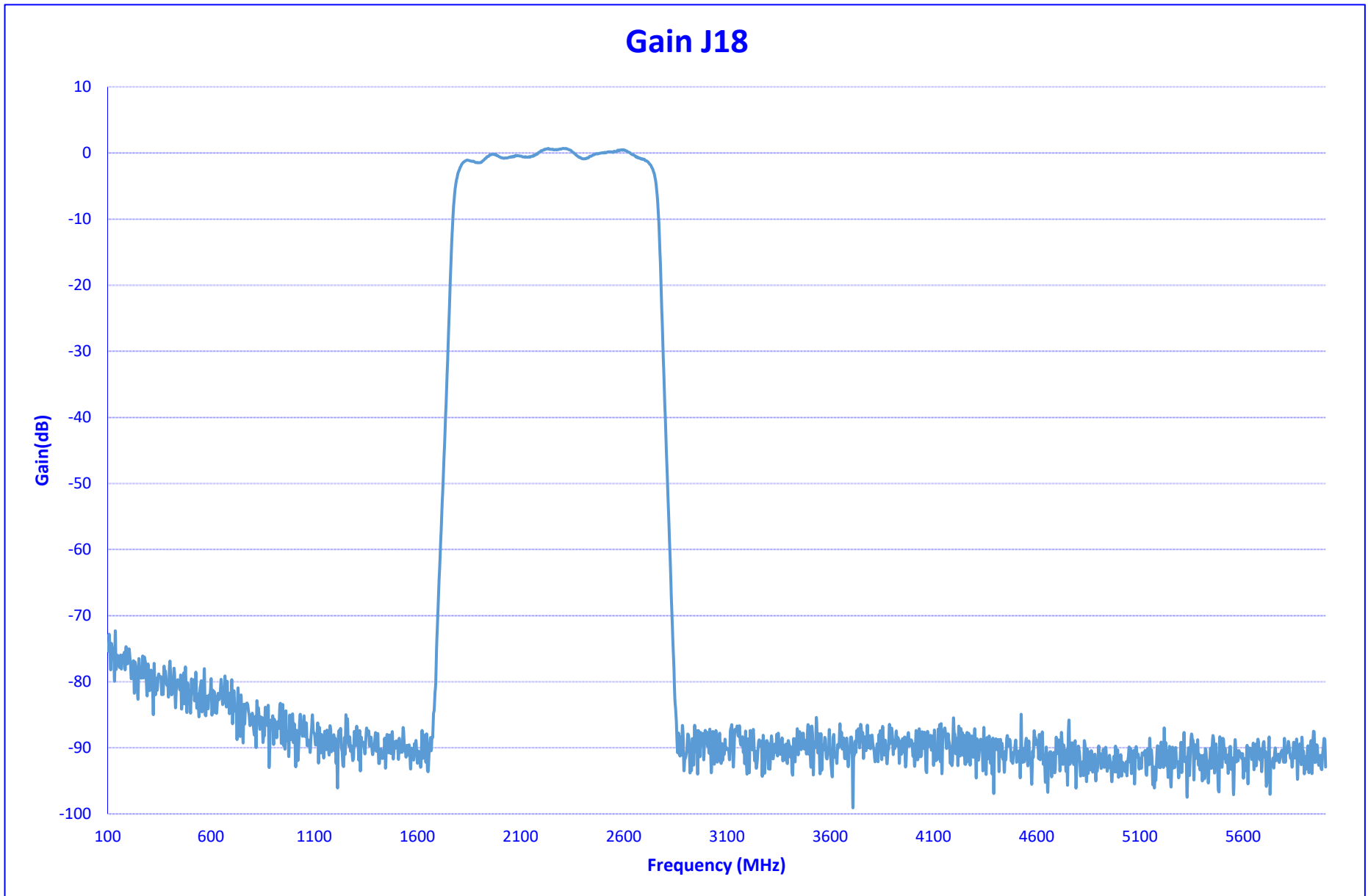



TYPICAL CHARACTERISTICS
ON
PRX-20-1G18G-850M-SFF-V2

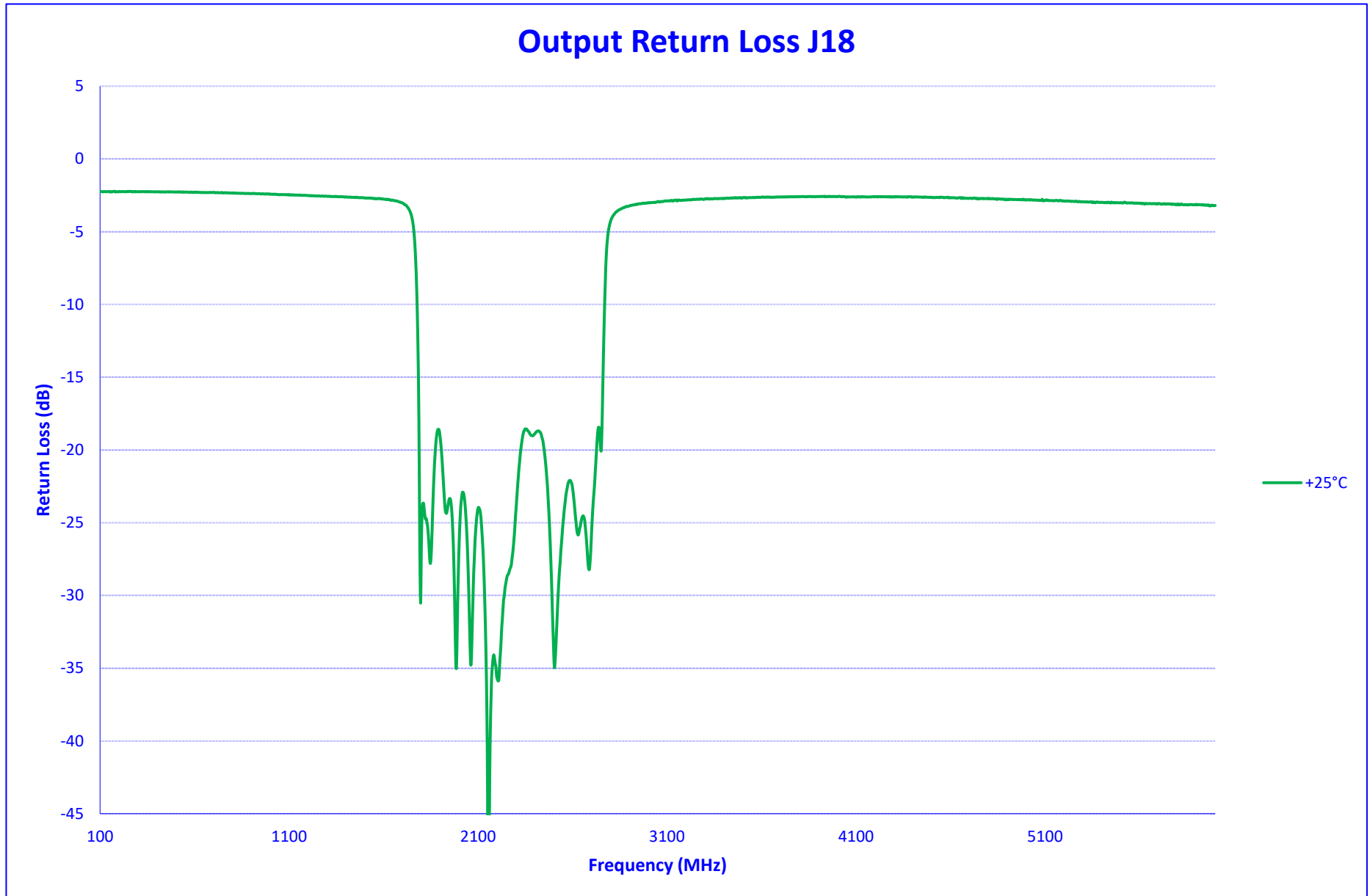



**TYPICAL CHARACTERISTICS
ON
PRX-20-1G18G-850M-SFF-V2**

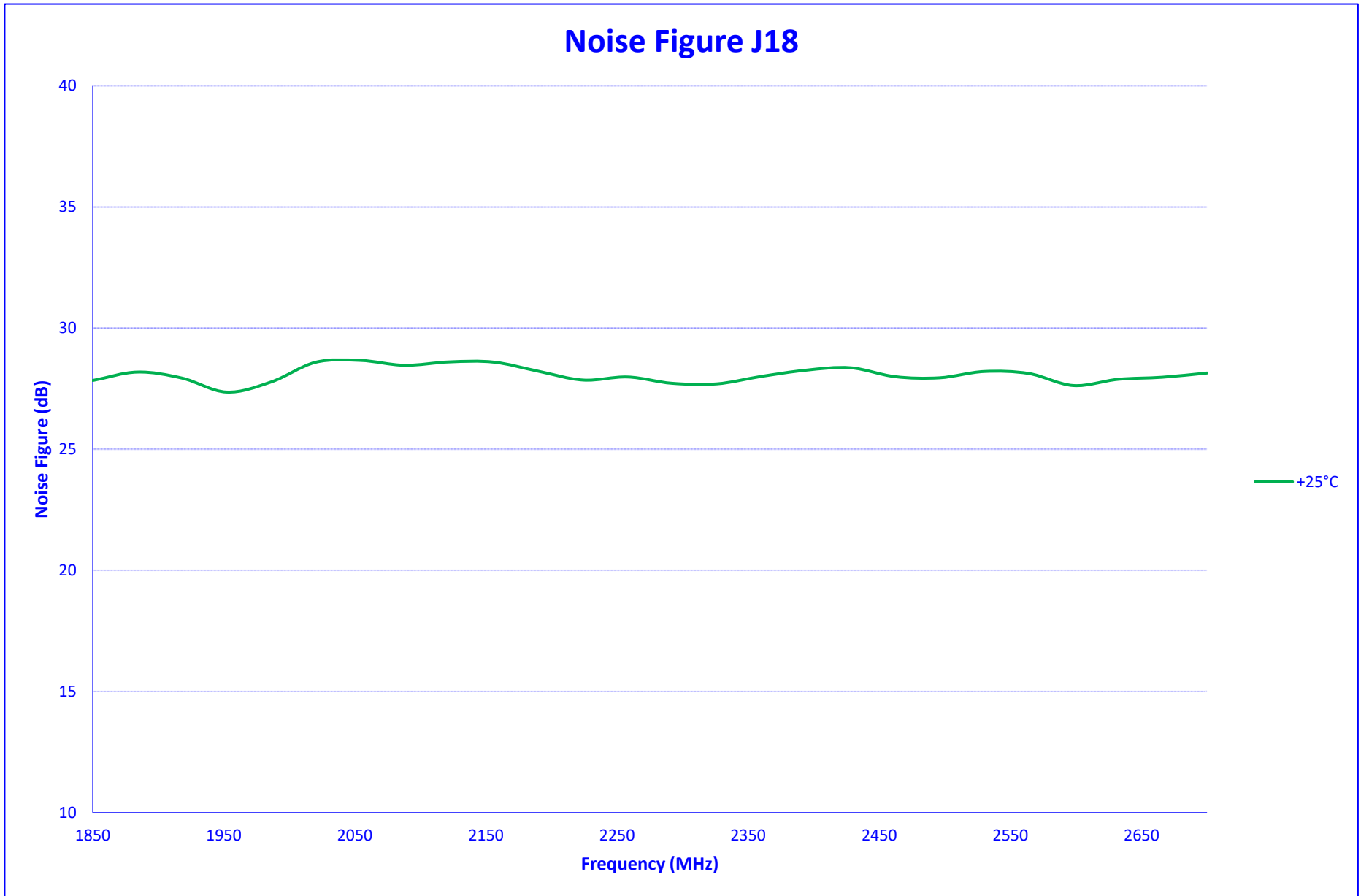



**TYPICAL CHARACTERISTICS
ON
PRX-20-1G18G-850M-SFF-V2**

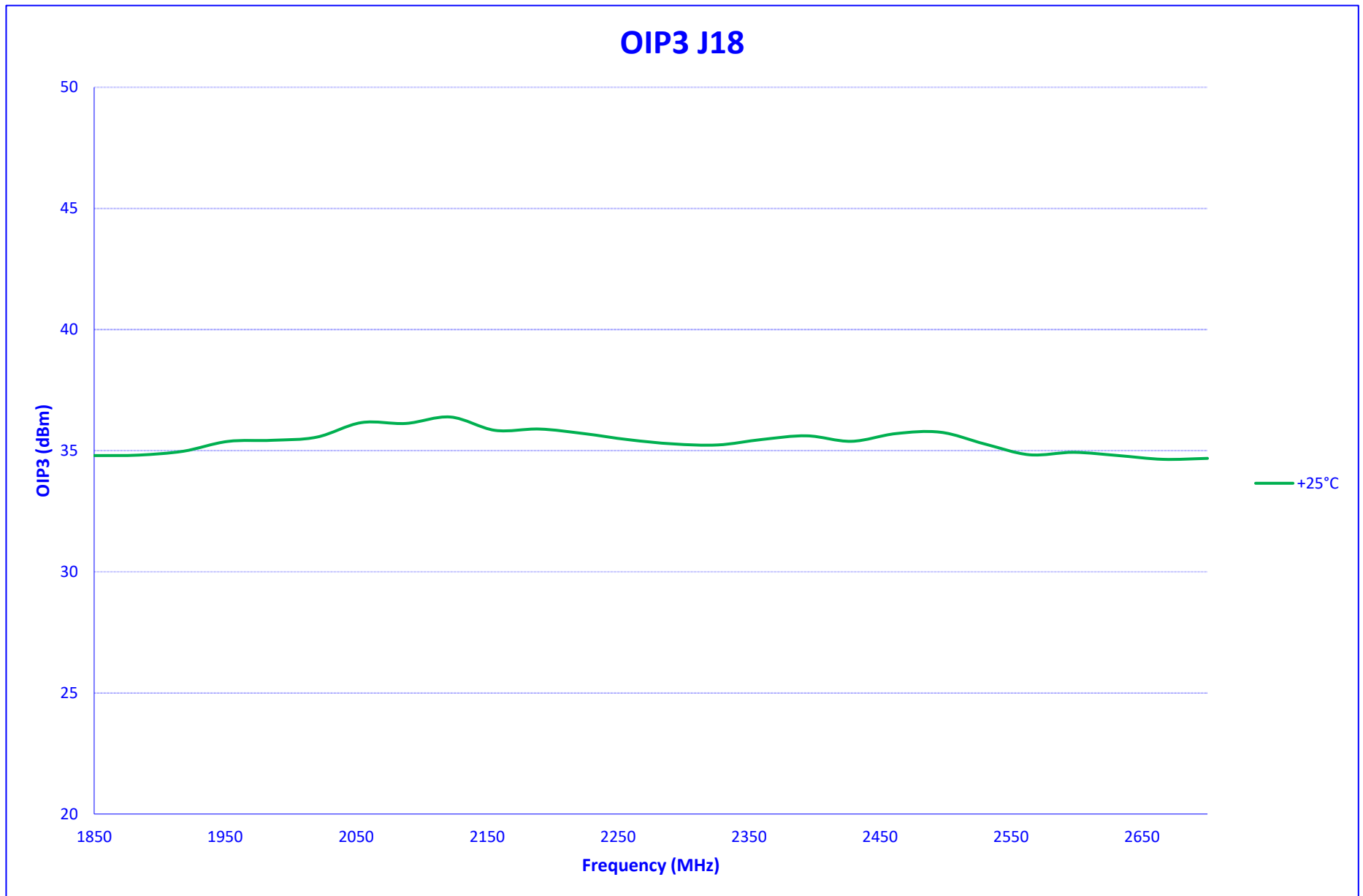



TYPICAL CHARACTERISTICS
ON
PRX-20-1G18G-850M-SFF-V2

IN BAND SPURS J18

25°C

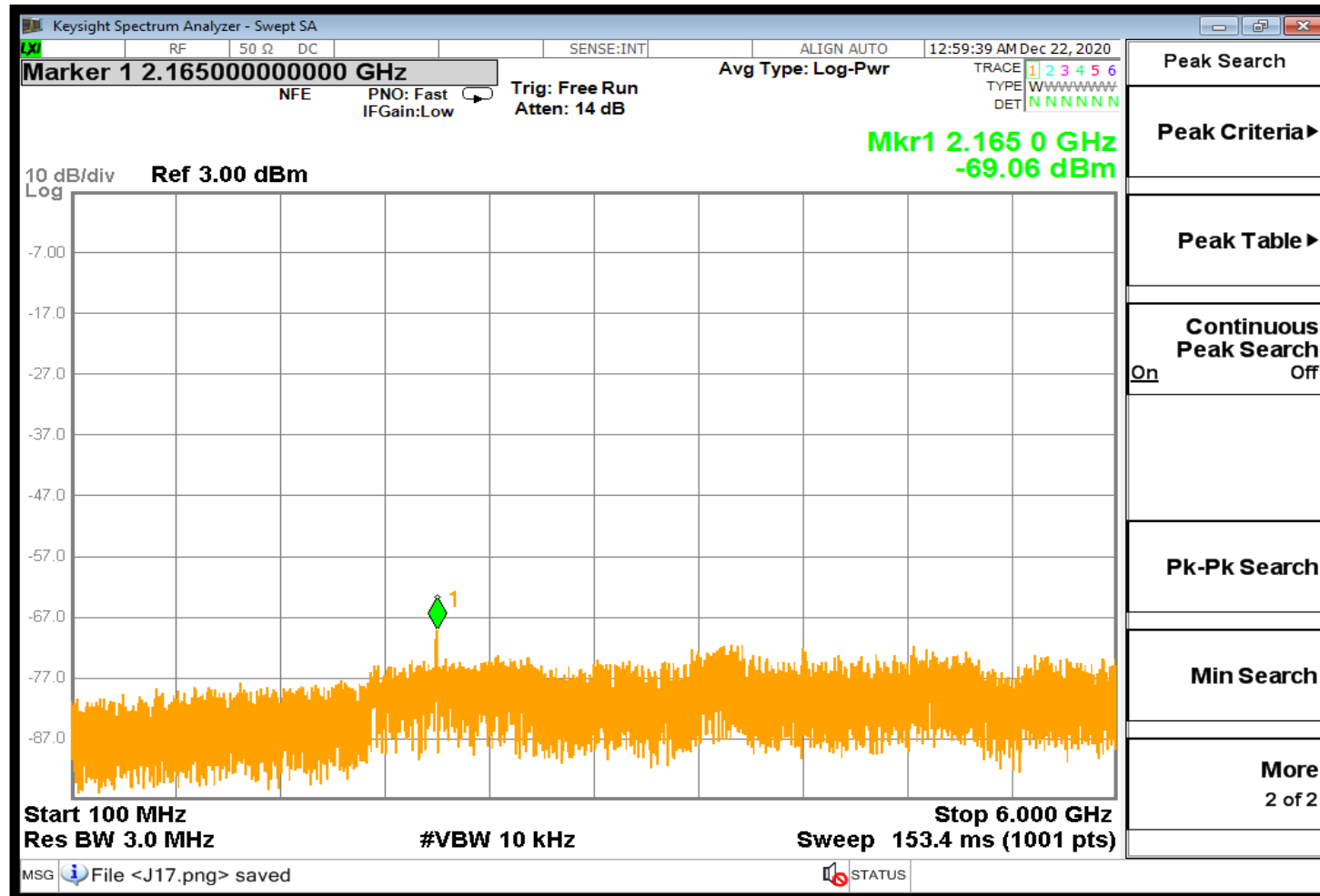



**TYPICAL CHARACTERISTICS
ON
PRX-20-1G18G-850M-SFF-V2**

SUMMARY DATA J19

TEST NO	PARAMETERS	SPECIFIED VALUE	TEST RESULTS
Input Frequency: 16300 - 17150 MHz			+25°C
1	Frequency Range J19:	2700 MHz to 3550 MHz	2700 MHz to 3550 MHz
2	Power Input:	-60 to 0 dBm	-60 to 0 dBm
3	Gain J19:	0 dB ± 3 dB	-0.4 ± 2.2 dB
4	Noise Figure J19:	38 dB Typ	28.83 dB
5	Output IP3 J19:	30 dBm Typ	36.28 dBm
6	Output VSWR J19:	2 : 1 Max	1.4 : 1
7	Passband J19:	Lower 2690 MHz Typ	2674 MHz
		Upper 3560 MHz Typ	3581 MHz
		Passband 870 MHz Typ	907 MHz
8	Stopband J19:	Lower 2485 MHz Typ	2571 MHz
		Upper 3765 MHz Typ	3703 MHz
		Stopband 1400 MHz Max	1132 MHz
9	Worst Case Spur: (Powered, No RF Input)	-60 dBm Typ	-71.37 dBm
10	Inband Worst Case Spur: (1-18 GHz RF Input)	-60 dBm Typ	None



**TYPICAL CHARACTERISTICS
ON
PRX-20-1G18G-850M-SFF-V2**

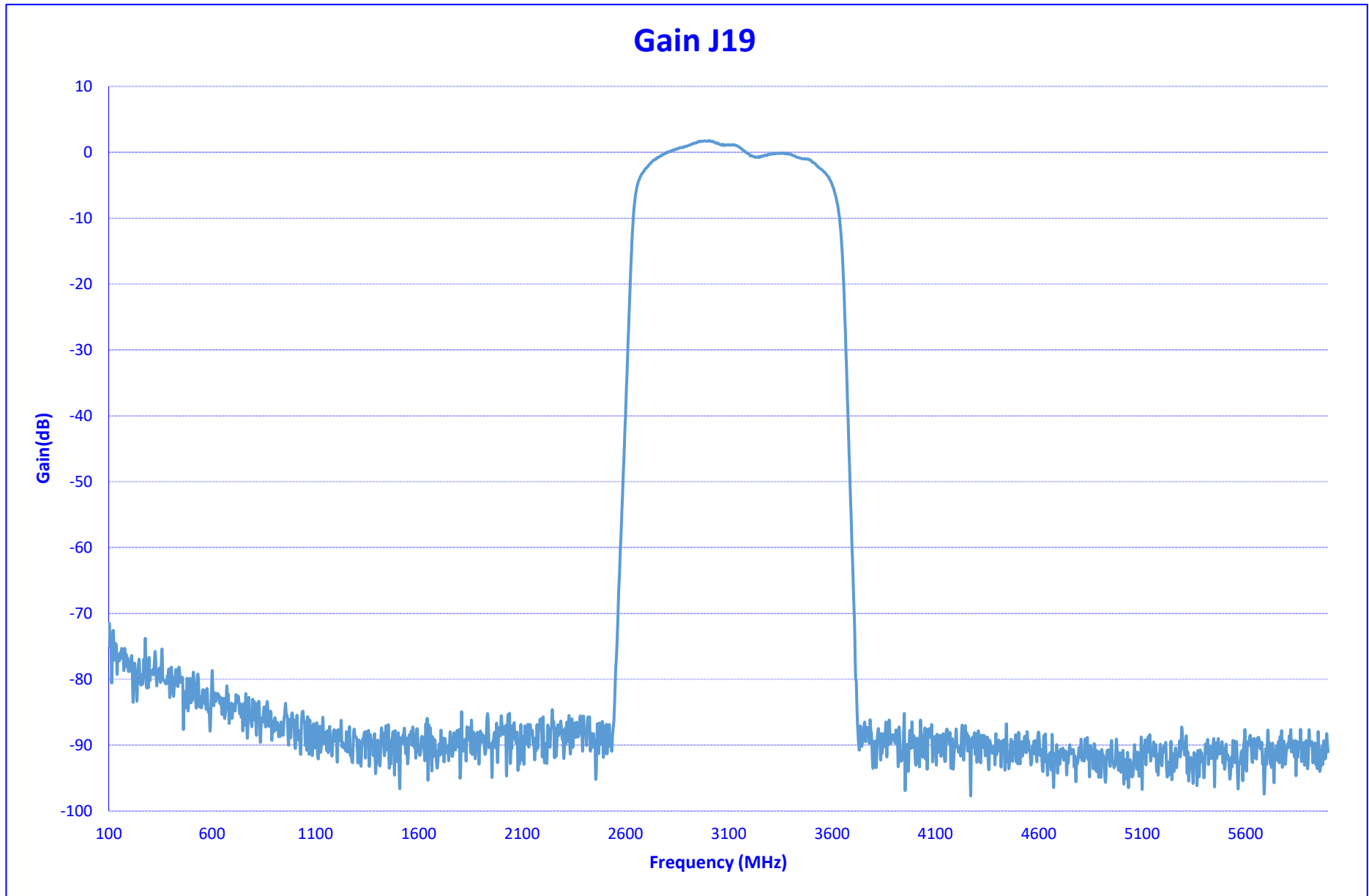



TYPICAL CHARACTERISTICS
ON
PRX-20-1G18G-850M-SFF-V2

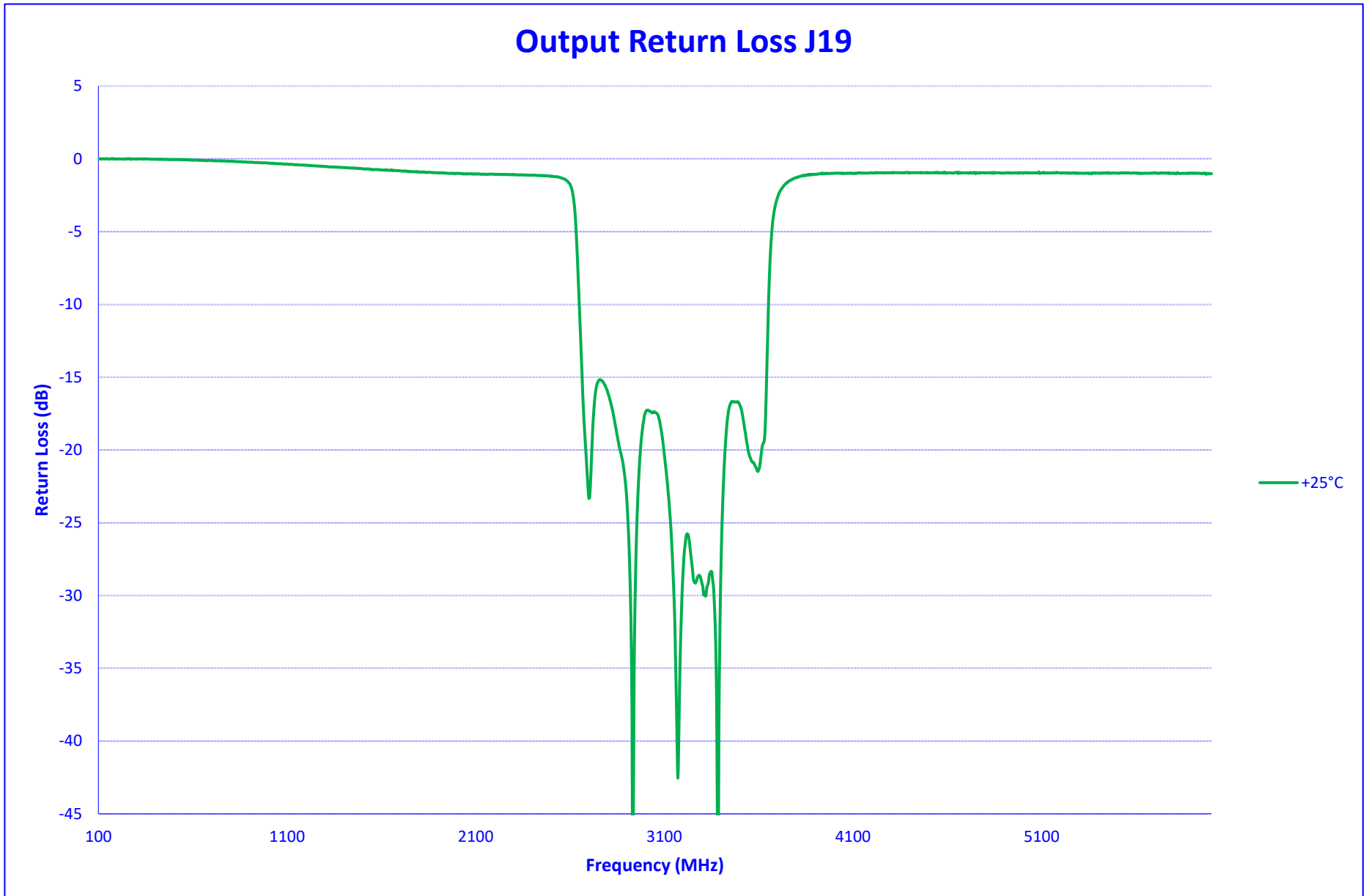



**TYPICAL CHARACTERISTICS
ON
PRX-20-1G18G-850M-SFF-V2**

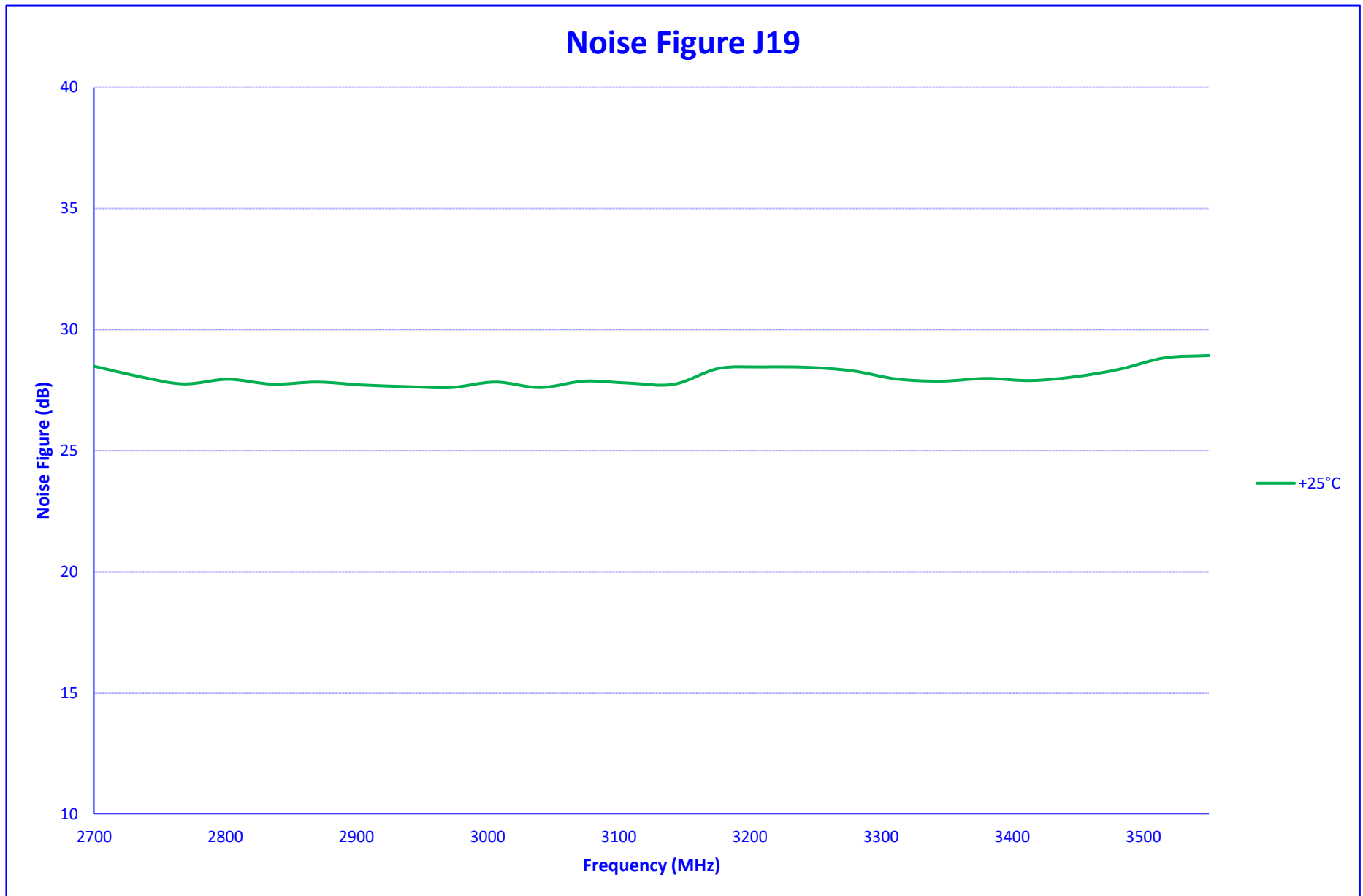



**TYPICAL CHARACTERISTICS
ON
PRX-20-1G18G-850M-SFF-V2**

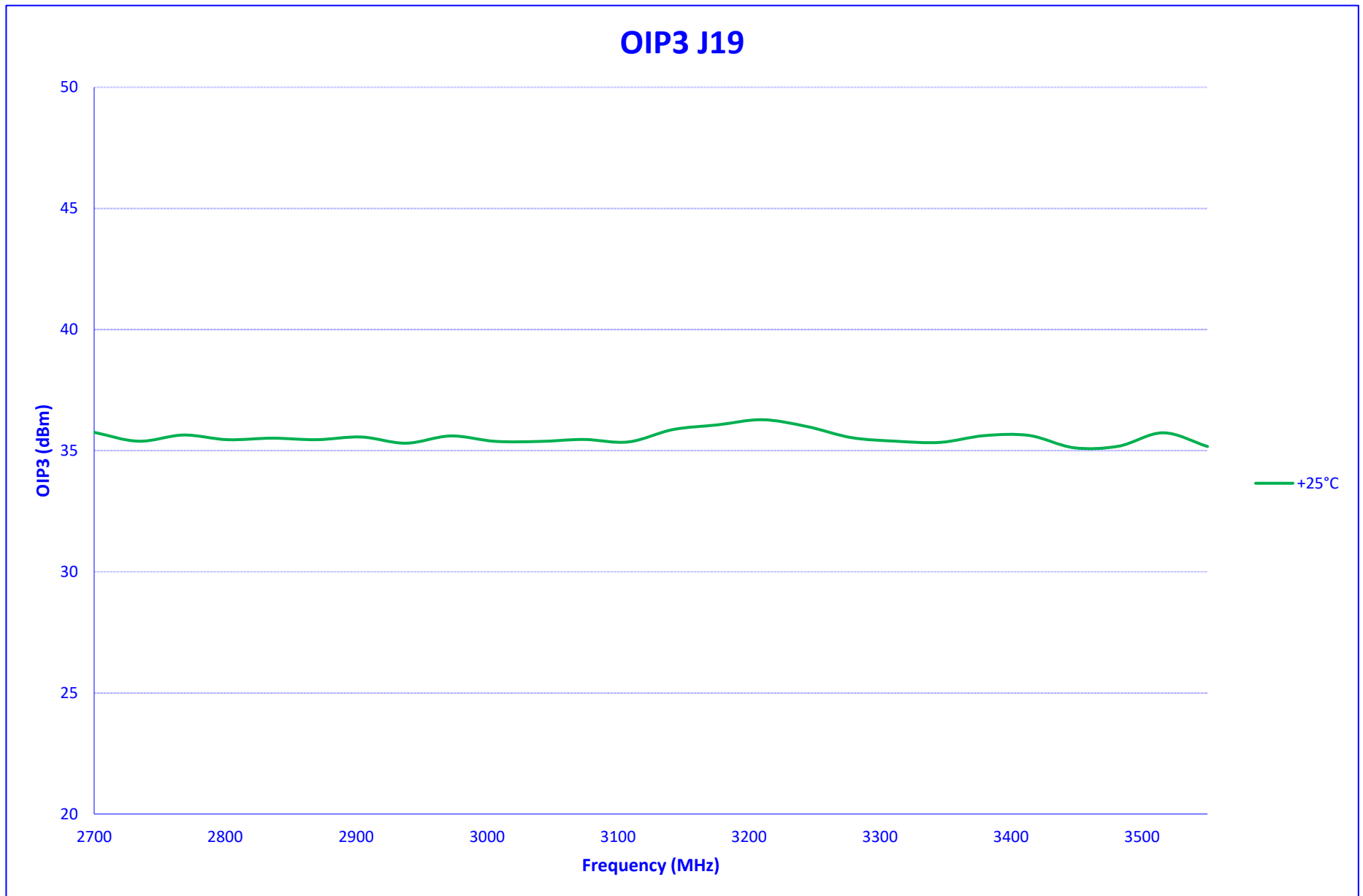



TYPICAL CHARACTERISTICS
ON
PRX-20-1G18G-850M-SFF-V2

IN BAND SPURS J19

25°C

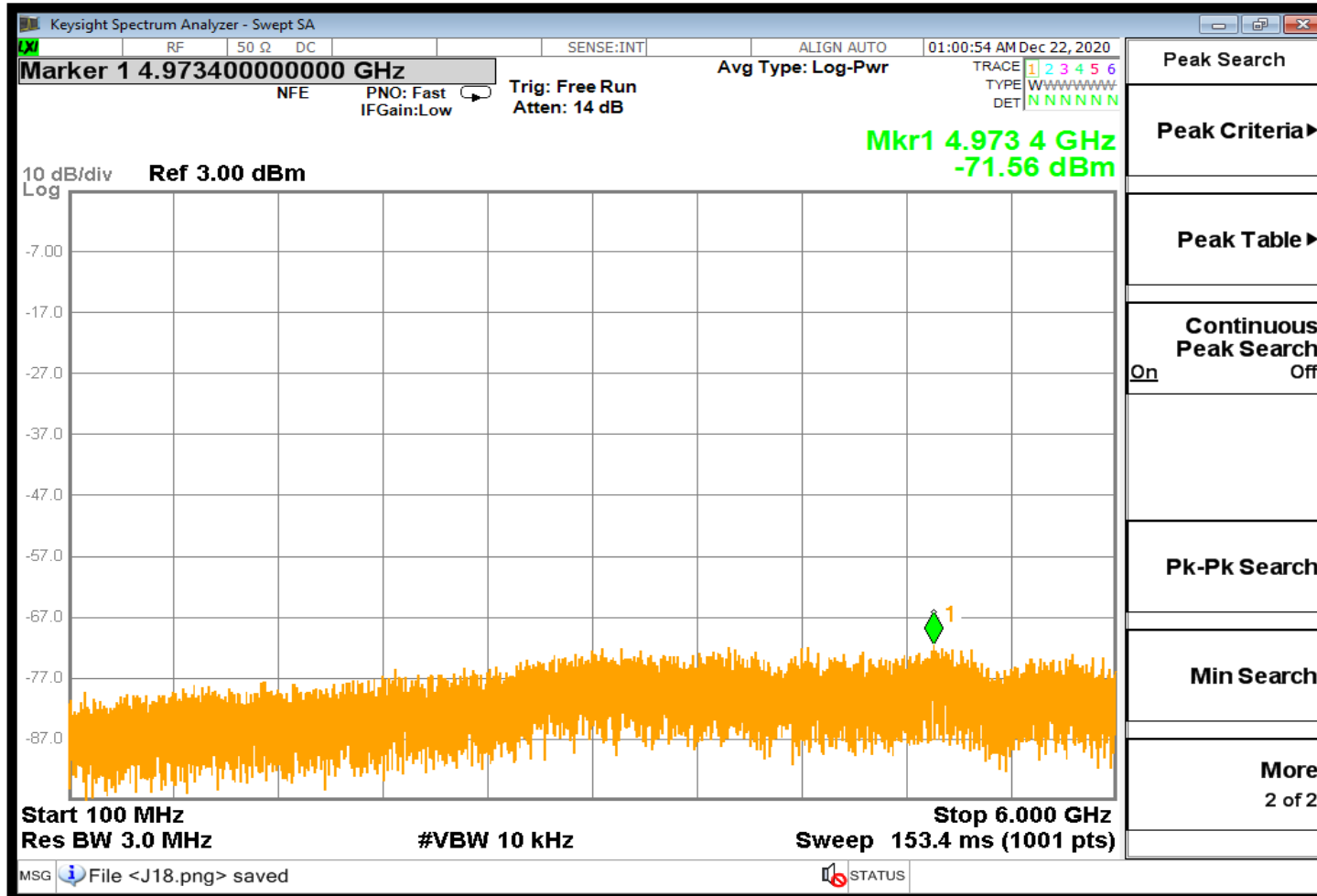



**TYPICAL CHARACTERISTICS
ON
PRX-20-1G18G-850M-SFF-V2**

SUMMARY DATA J20

TEST NO	PARAMETERS	SPECIFIED VALUE	TEST RESULTS
Input Frequency: 17150 - 18000 MHz			+25°C
1	Frequency Range J20:	3550 MHz to 4400 MHz	3550 MHz to 4400 MHz
2	Power Input:	-60 to 0 dBm	-60 to 0 dBm
3	Gain J20:	0 dB ± 3 dB	-0.7 ± 1.9 dB
4	Noise Figure J20:	38 dB Typ	31.05 dB
5	Output IP3 J20:	30 dBm Typ	32.41 dBm
6	Output VSWR J20:	2 : 1 Max	1.5 : 1
7	Passband J20:	Lower 3540 MHz Typ	3511 MHz
		Upper 4410 MHz Typ	4451 MHz
		Passband 870 MHz Typ	940 MHz
8	Stopband J20:	Lower 3275MHz Typ	3389 MHz
		Upper 4675 MHz Typ	4569 MHz
		Stopband 1400 MHz Max	1180 MHz
9	Worst Case Spur: (Powered, No RF Input)	-60 dBm Typ	-70.49 dBm
10	Inband Worst Case Spur: (1-18 GHz RF Input)	-60 dBm Typ	-60.61 dBm



TYPICAL CHARACTERISTICS
ON
PRX-20-1G18G-850M-SFF-V2

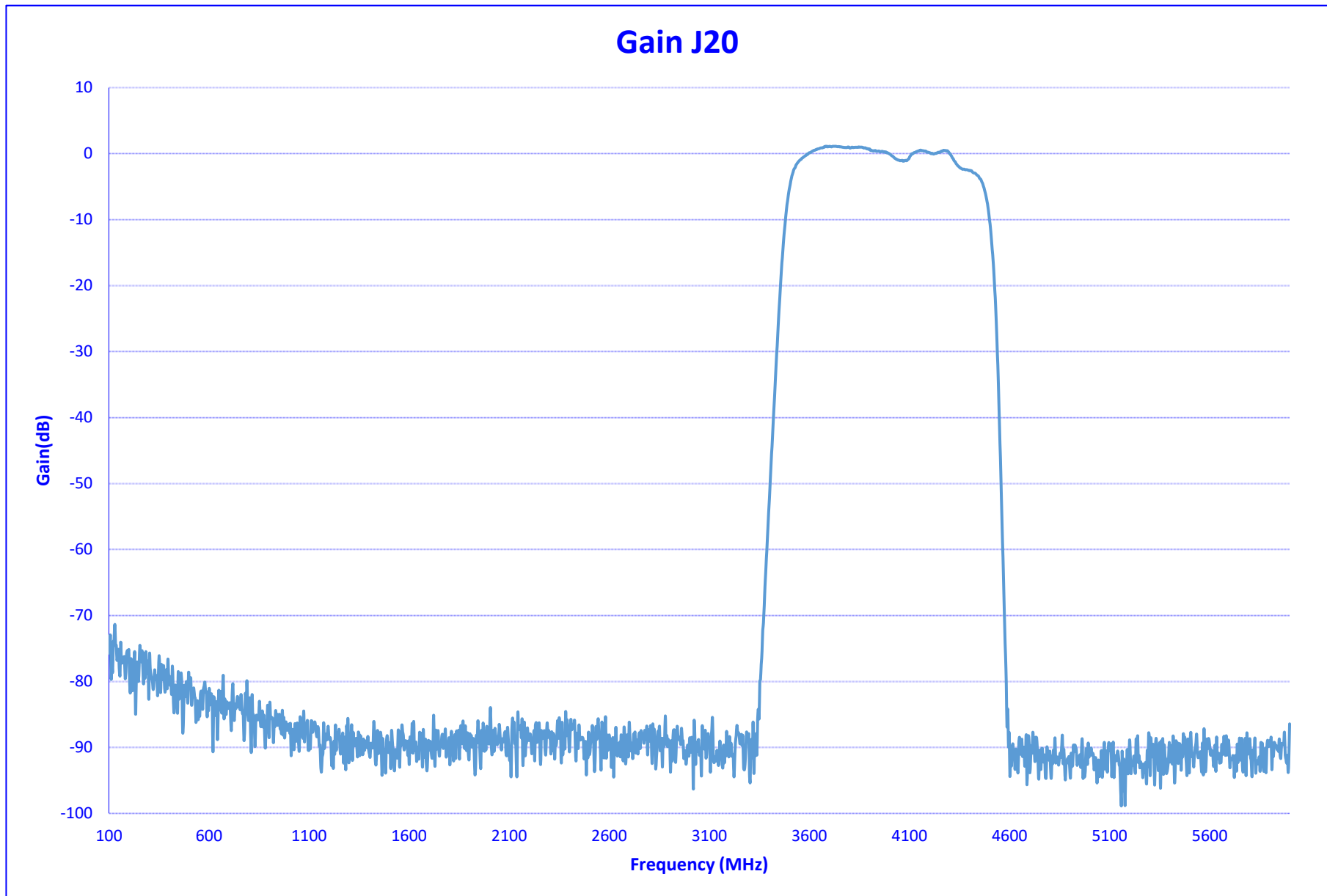



TYPICAL CHARACTERISTICS
ON
PRX-20-1G18G-850M-SFF-V2

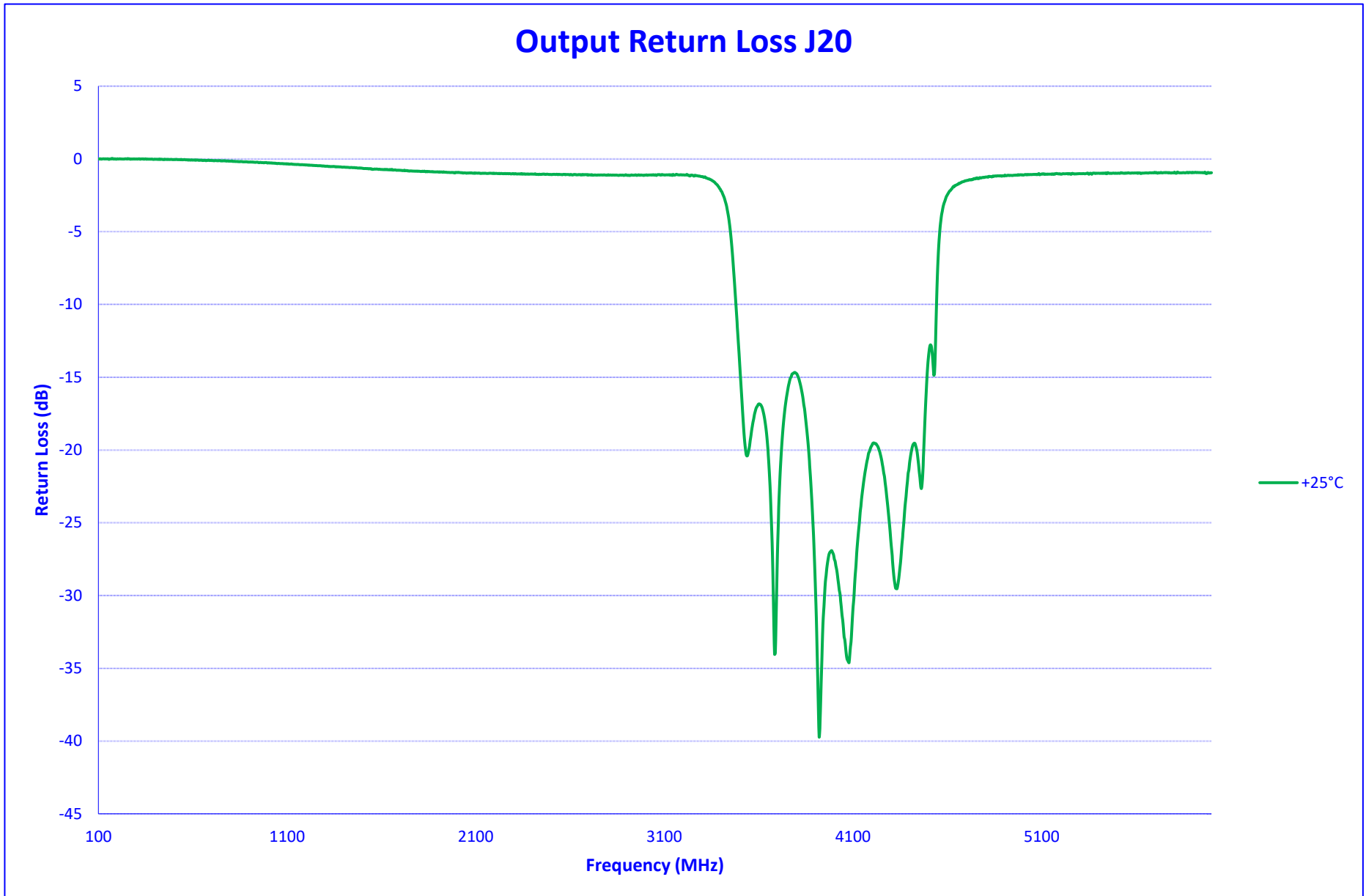



**TYPICAL CHARACTERISTICS
ON
PRX-20-1G18G-850M-SFF-V2**

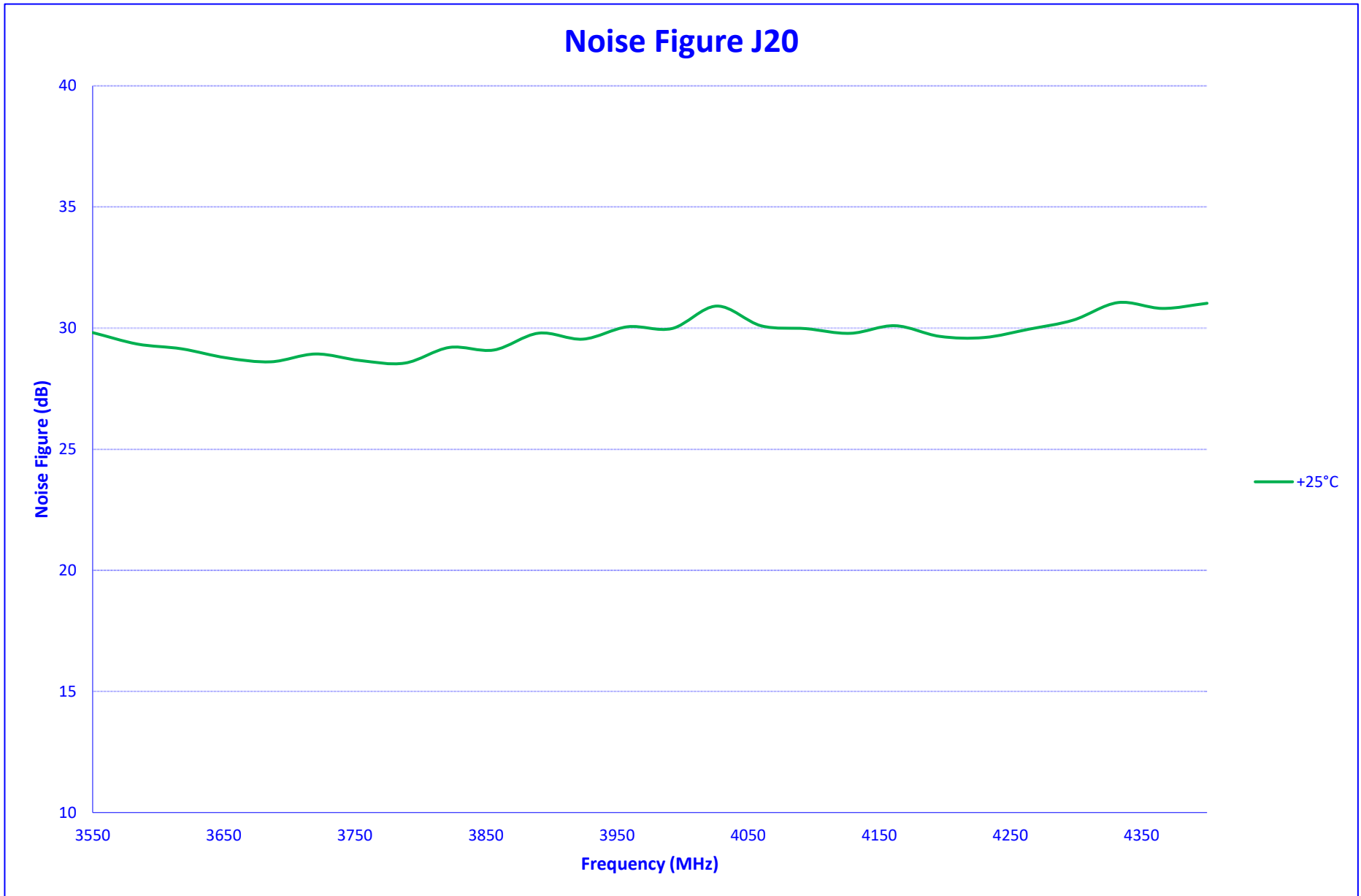



**TYPICAL CHARACTERISTICS
ON
PRX-20-1G18G-850M-SFF-V2**

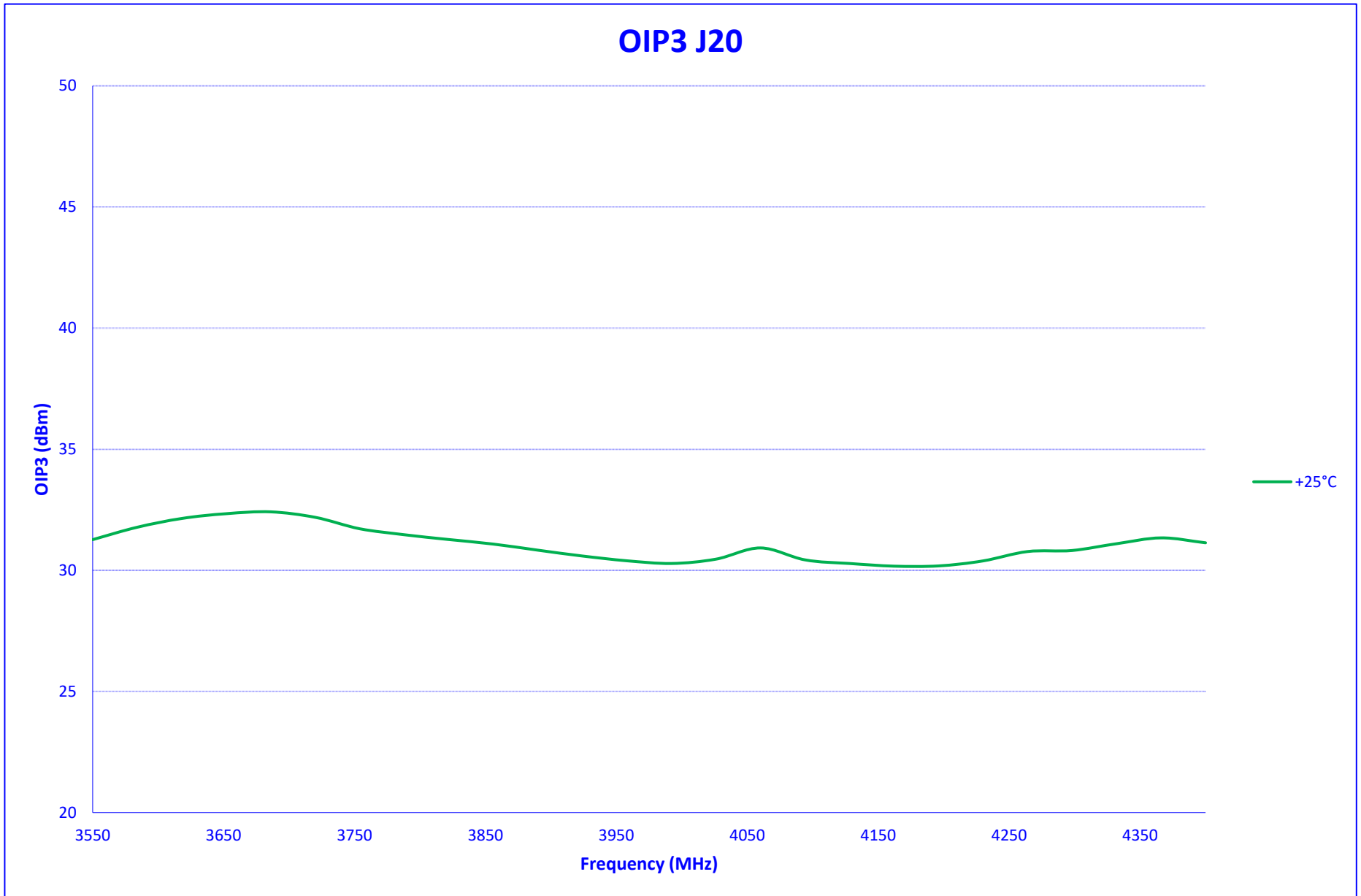



TYPICAL CHARACTERISTICS
ON
PRX-20-1G18G-850M-SFF-V2

IN BAND SPURS J20

25°C

