



Defining & Delivering the Future of Mission-Critical Electronics

JUNE 5TH, 2026



Planar Monolithics Overview

**Defining & Delivering the Future
of Mission-Critical Electronics**

- Global leader within military, space and commercial markets
- Design & manufacture of Quality RF & Microwave Components & Integrated Module Assemblies
- Offers 4500+ Hi-Rel commercial off-the-shelf (COTS) models with test results, S-parameters, 3D models and detailed specs available
- Every product is built to rigorous MIL-STD specs
- ITAR, ISO-9001 & AS9100D Certifications
- Industry-leading sales and applications support, leading to lower costs and faster lead times than competitive options.

Design and Manufacturing Locations

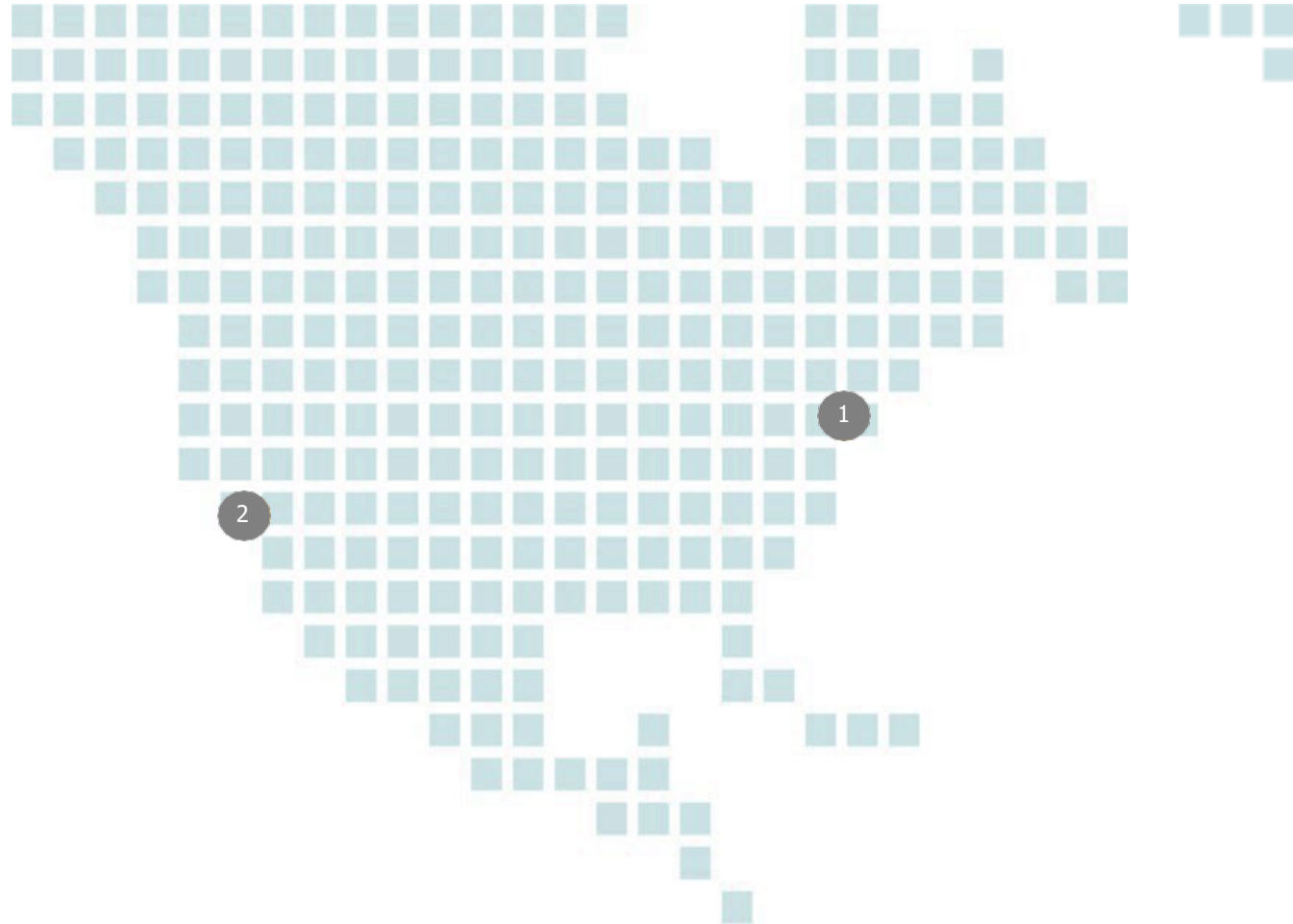

RF & Microwave

- 1 PMI – Frederick, Maryland
East Coast Operation
7309-A Grove Road
Frederick, MD 21704 USA
- 2 PMI – EL Dorado Hills, California
West Coast Operation
4921 Robert Mathews PKWY, Suite 1
EL Dorado Hills, CA 95762 USA

Tel: 301.662.5019

TEL: 916.542.1401

sales@pmi-rf.com

www.pmi-rf.com

Milestones & Accreditations

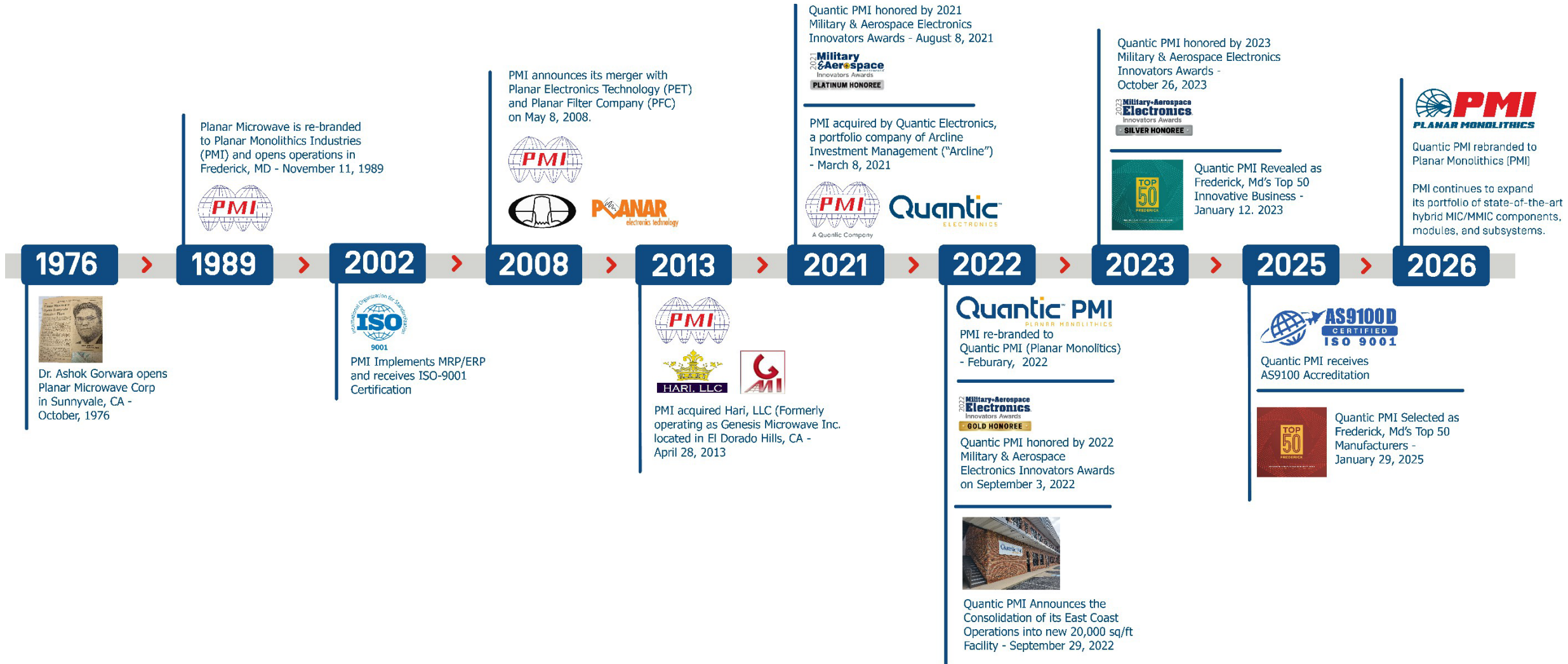

Aerospace & Defense (A&D)



Proven mission critical designs that meet the demanding requirements of secure communication, radar, electronic warfare, and satellite systems providing reliable and efficient performance in mission-critical environments.

Test & Measurement (T&M)

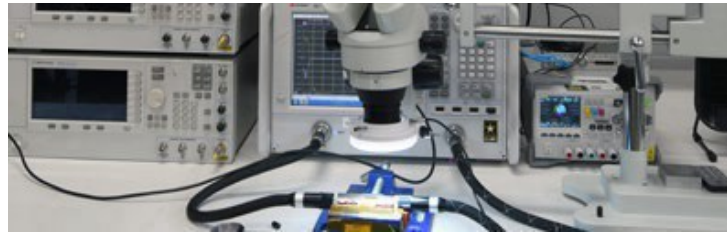

Designs include high-end RF Safety, Monitoring solutions & Antenna Measurements for multiple industries including telecommunications, aerospace, & defense (A&D), & diversified industrial with global product distribution.

Space / SATCOM Industrial & Commercial



Solutions include up- and down-converters for military satellite control network, & other amplifier and power control solutions for military and civilian satellite-based communication applications.



Design & Applications

RF, Microwave & mmWave



As a manufacturer PMI utilizes our own designs for all components, integrated modules and subsystems

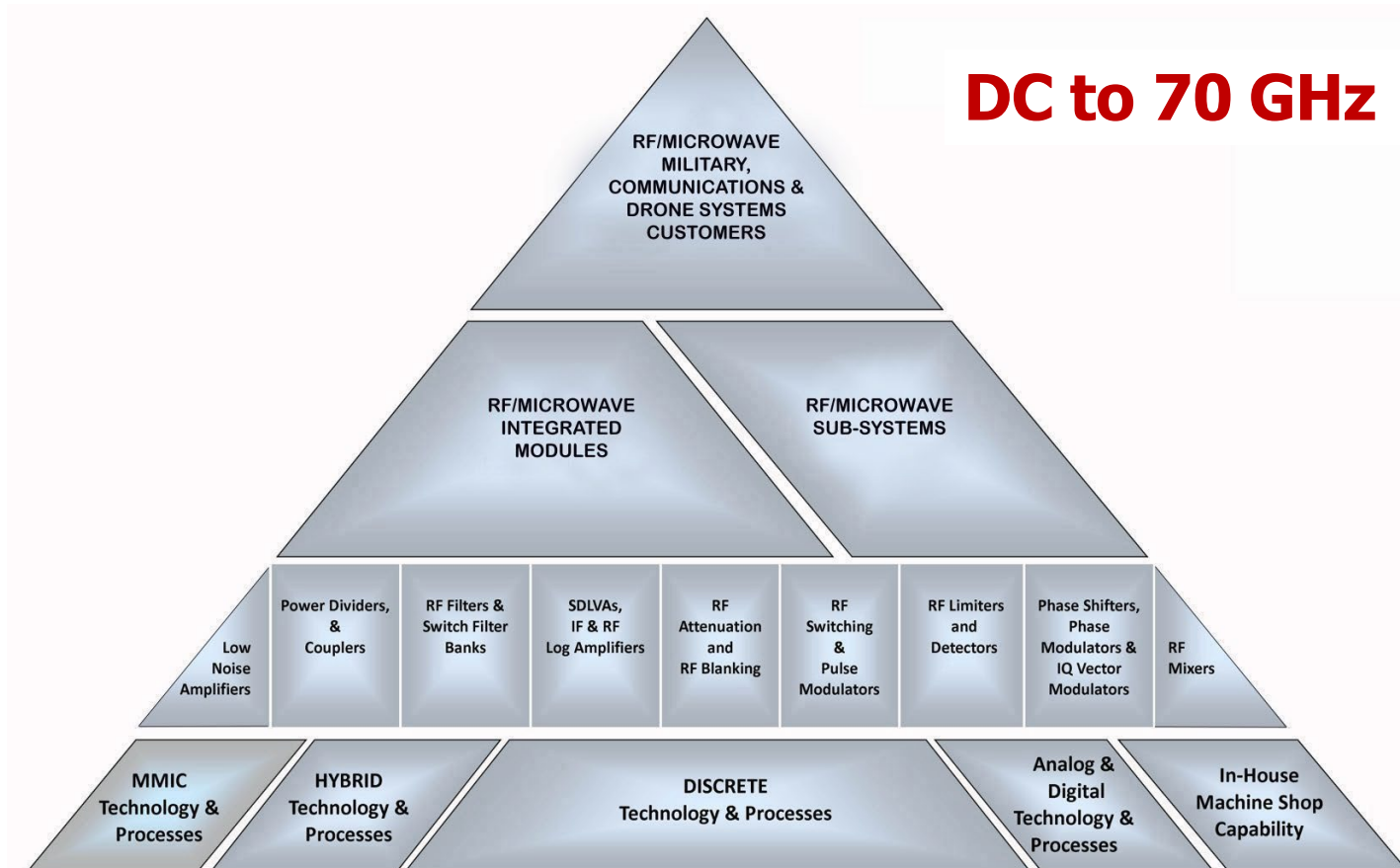

Applications of PMI Components & Sub-Systems

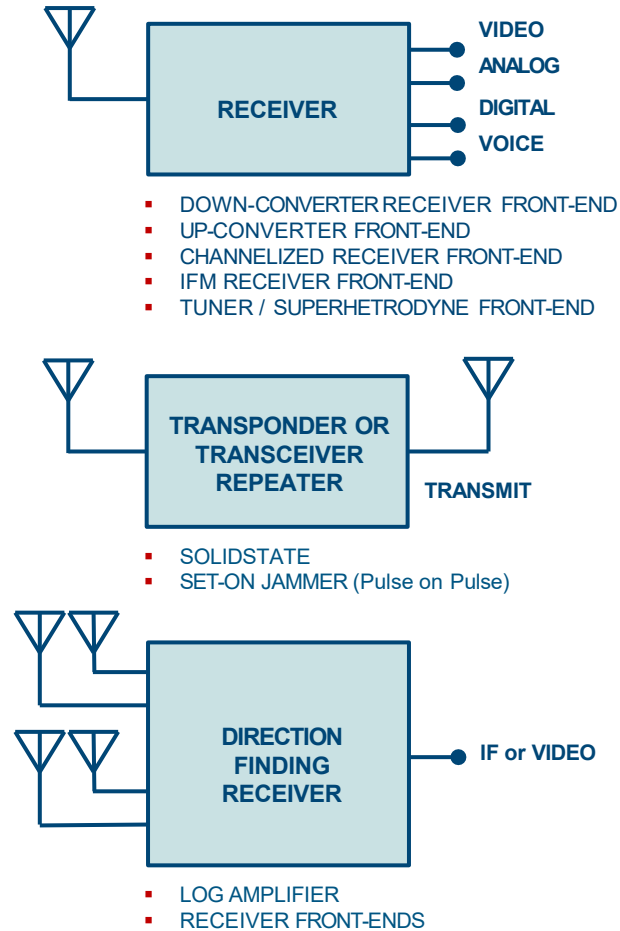

PMI (Planar Monolithics) has been in business for over 35 years as a world-class designer and manufacturer of electronic components and subsystems for mission critical applications such as **Receiver Front-Ends, Synthesizers, and Transceivers**. A large variety of **RF components and integrated modules** have been developed to compliment this target market. Our technical goal is to produce the finest products available that resolve this mathematical statement:

$$V_{(\text{input})} = A \cos(\omega_c t + \phi_t)$$

↓ ↓ ↓

AMPLITUDE FREQUENCY PHASE & MODULATION

TYPICAL EW, ECM, ESM RECEIVER FRONT-END

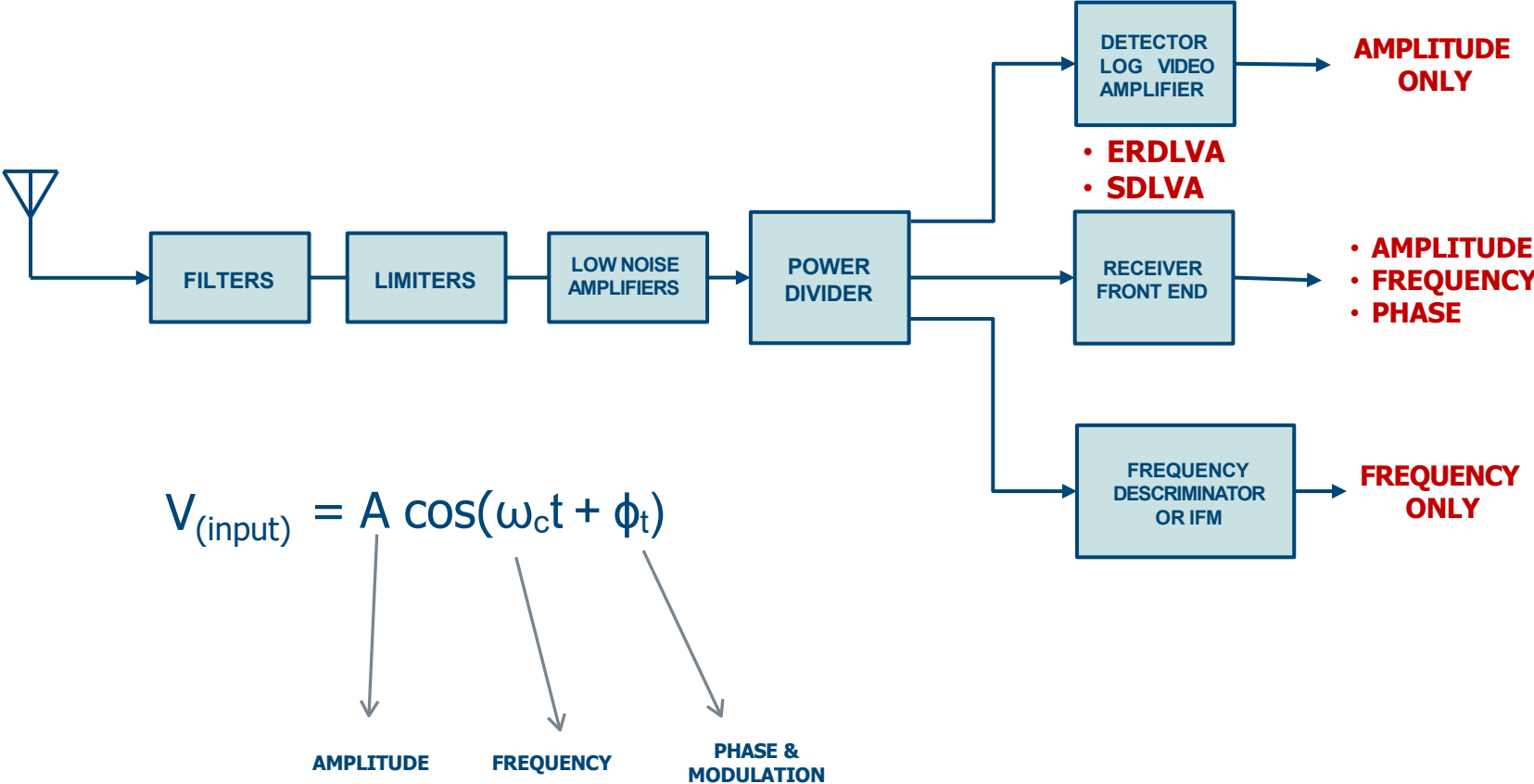

TYPICAL EW, ECM, ESM RECEIVER FRONT-END

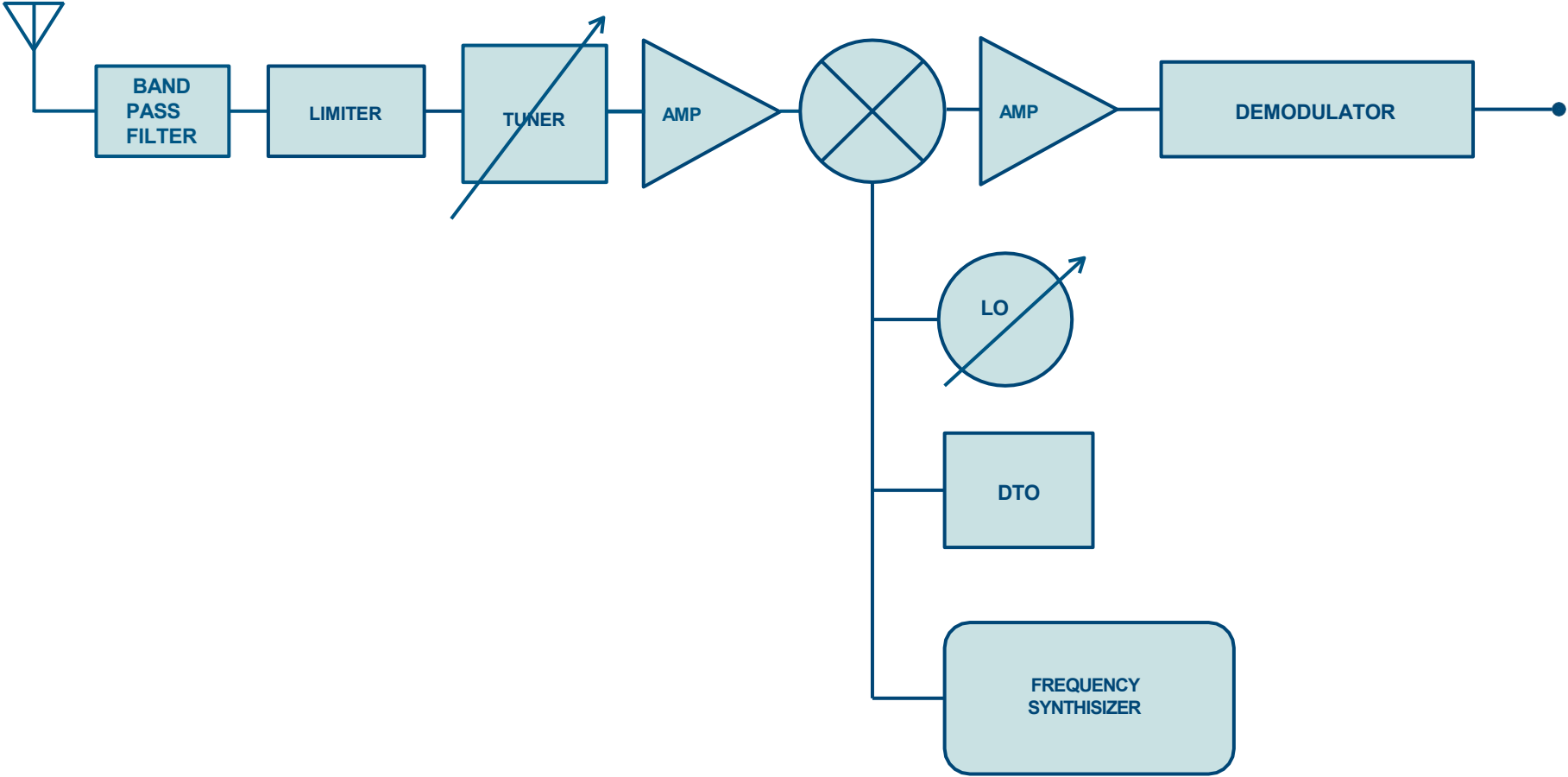

TYPICAL TRANSCEIVER / TRANSPONDER BLOCK DIAGRAM

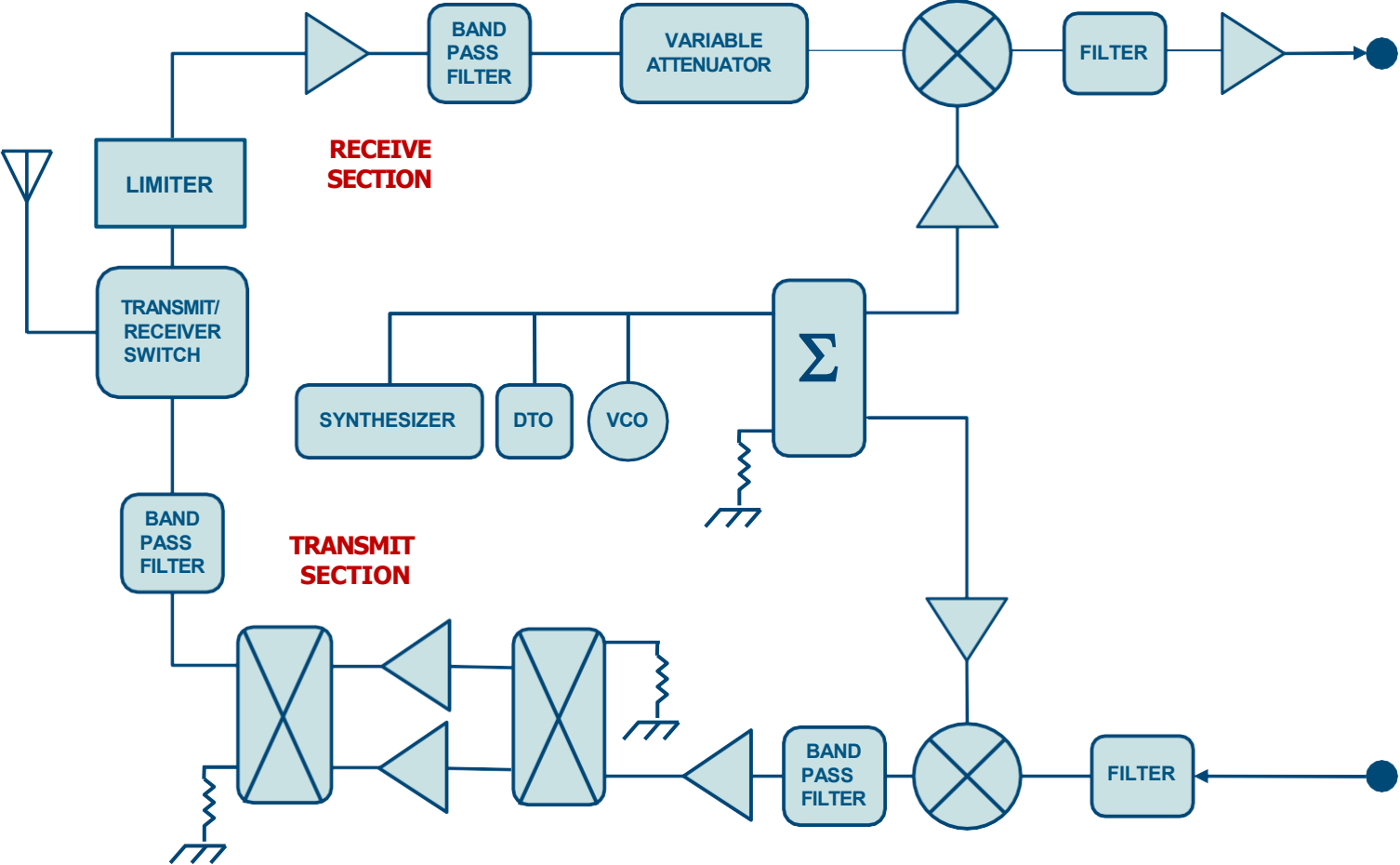

TYPICAL RADAR WARNING RECEIVER FRONT-END OR DIRECTION-FINDING RECEIVER FRONT-END SUB-SYSTEM

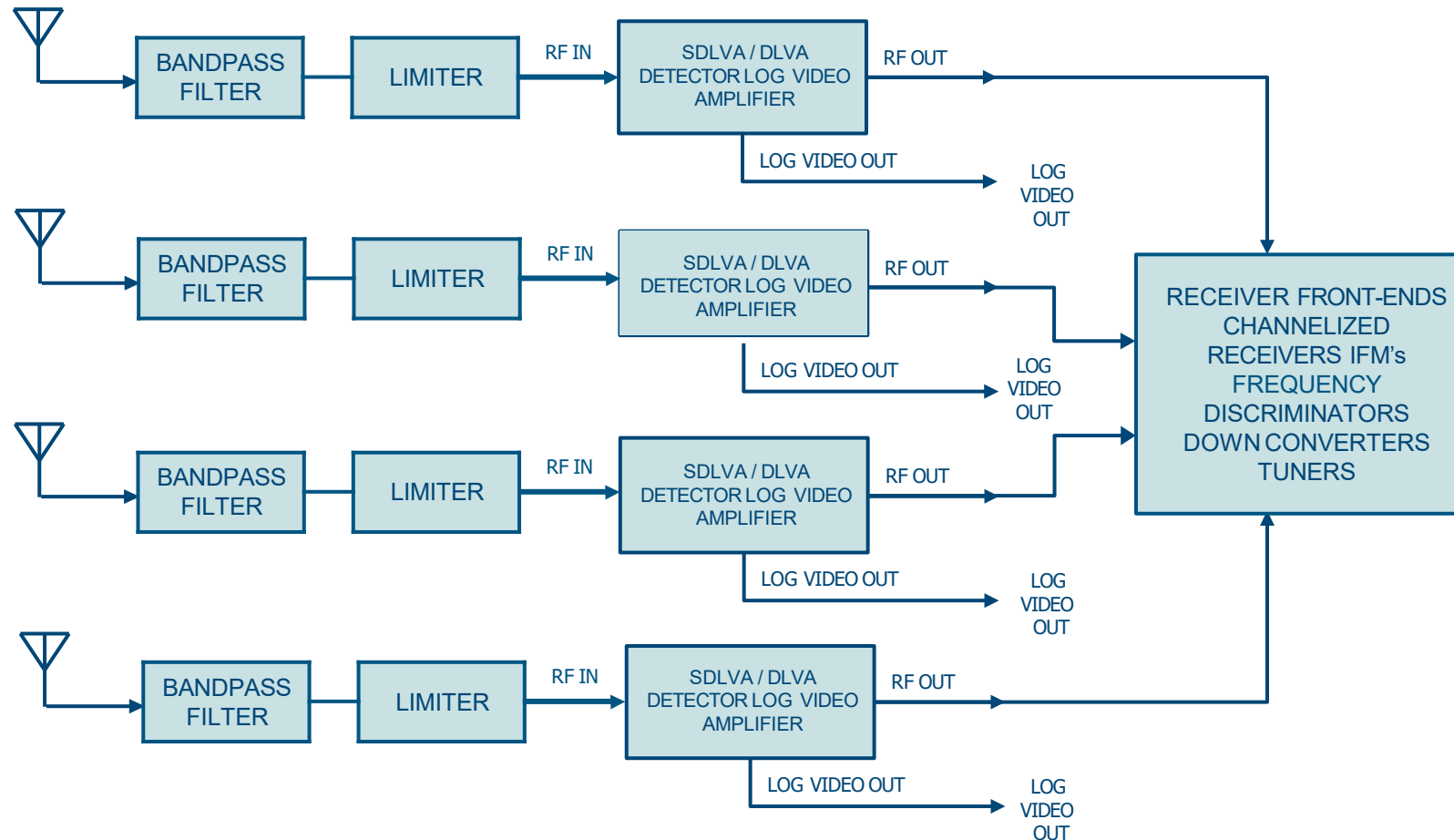

PMI can transform any MMIC or QFN into a DC – 70 GHz HI-REL Packaged Component

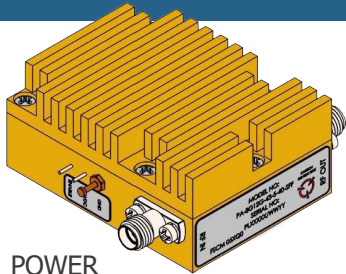

POWER



RUGGEDIZED

MINITURIZED

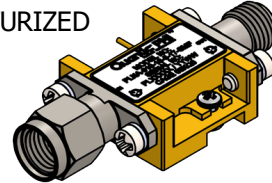

SURFACE MOUNT



CUSTOM
PACKAGING

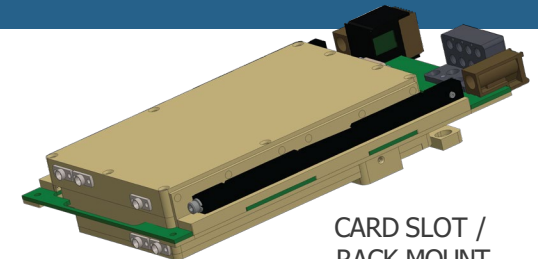
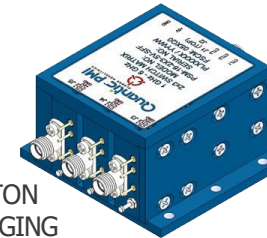

CARD SLOT /
RACK MOUNT

MIL-AERO – Hi-Rel Design & Packaging

- 20k sq/ft State of the art facility with 10k class cleanroom
- ISO9001 / AS9100 certified
- ITAR Registered and Facility Clearance
- Kick off Meeting / CDR / PDR
- Complete Document Package
- Mean time between failure analysis (MTBF report)
- MIL-STD-810 Environmental Stress Screening (ESS)
- Qualification Testing (QTP / QTR)
- 100% MIL-STD-883 Inspection (Precap / ATP / SI)
- First Article Inspection IAW AS9102
- Recurring production – Continuous Acquisition & Life-cycle support (CALs)

Custom & COTS Solutions include

- Assembly including wire, ribbon, ball bonding 100% pull tested
- Hermetic, screw or epoxy sealing
- Form, Fit, Function Services
- Over voltage and reverse protection
- Supply voltage conditioning (Regulation & noise filtering)
- Built in sequencing protection
- Control signals Digital or Analog
 - TTL, RS232, PECL, LVTTTL, BCD, Differential Pair
 - Simple DC analog voltage
- Broadband DC Blocking networks
- EMI / ESD Shielding & Protection

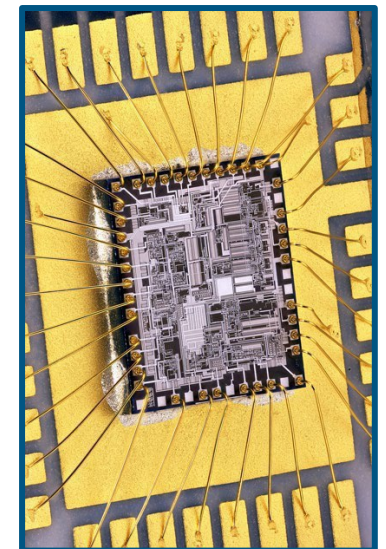

PMI is a Leader in EOL & Obsolete Aftermarket Manufacturing

PMI Specialties...

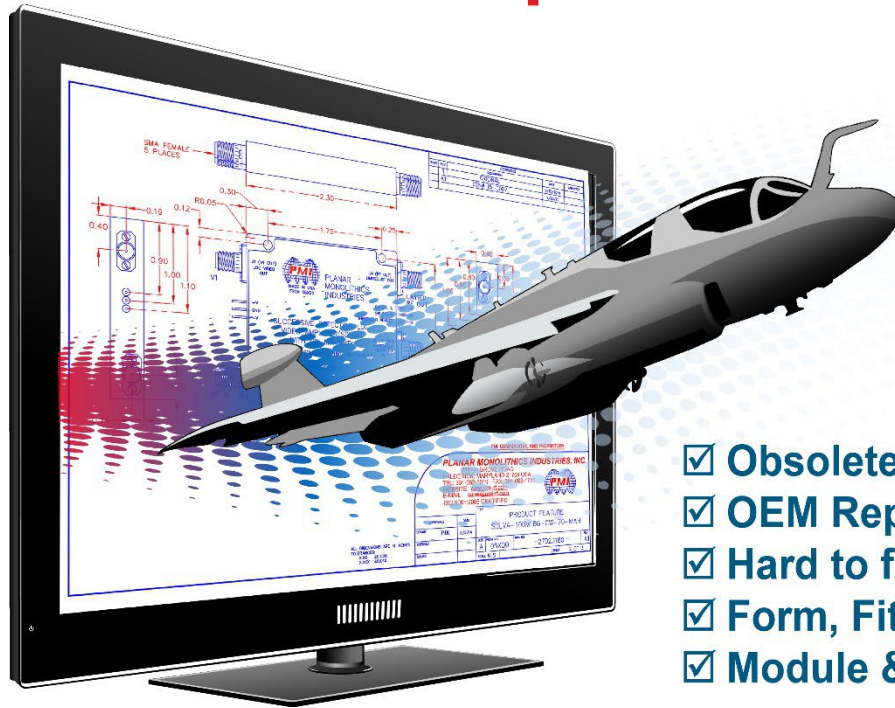

- ✓ **Obsolete Designs**
- ✓ **OEM Replacements**
- ✓ **Hard to find products**
- ✓ **Form, Fit, Functional**
- ✓ **Module & Subsystem Retrofits**

- Using Source Control Drawings (SCD), PMI offers a complete solution to meet or exceed the electrical, mechanical and environmental specifications.
- Specializing in aftermarket technology manufacturing and support for discontinued RF components, electronic circuits, digital circuits and Integrated circuits.
- PMI has the technical expertise to manufacture, supply and support the most demanding requirements.
- PMI is dedicated to assuring our customer base that older discontinued products will continue to be available.



RF, Microwave & mmWave

DC to 70 GHz

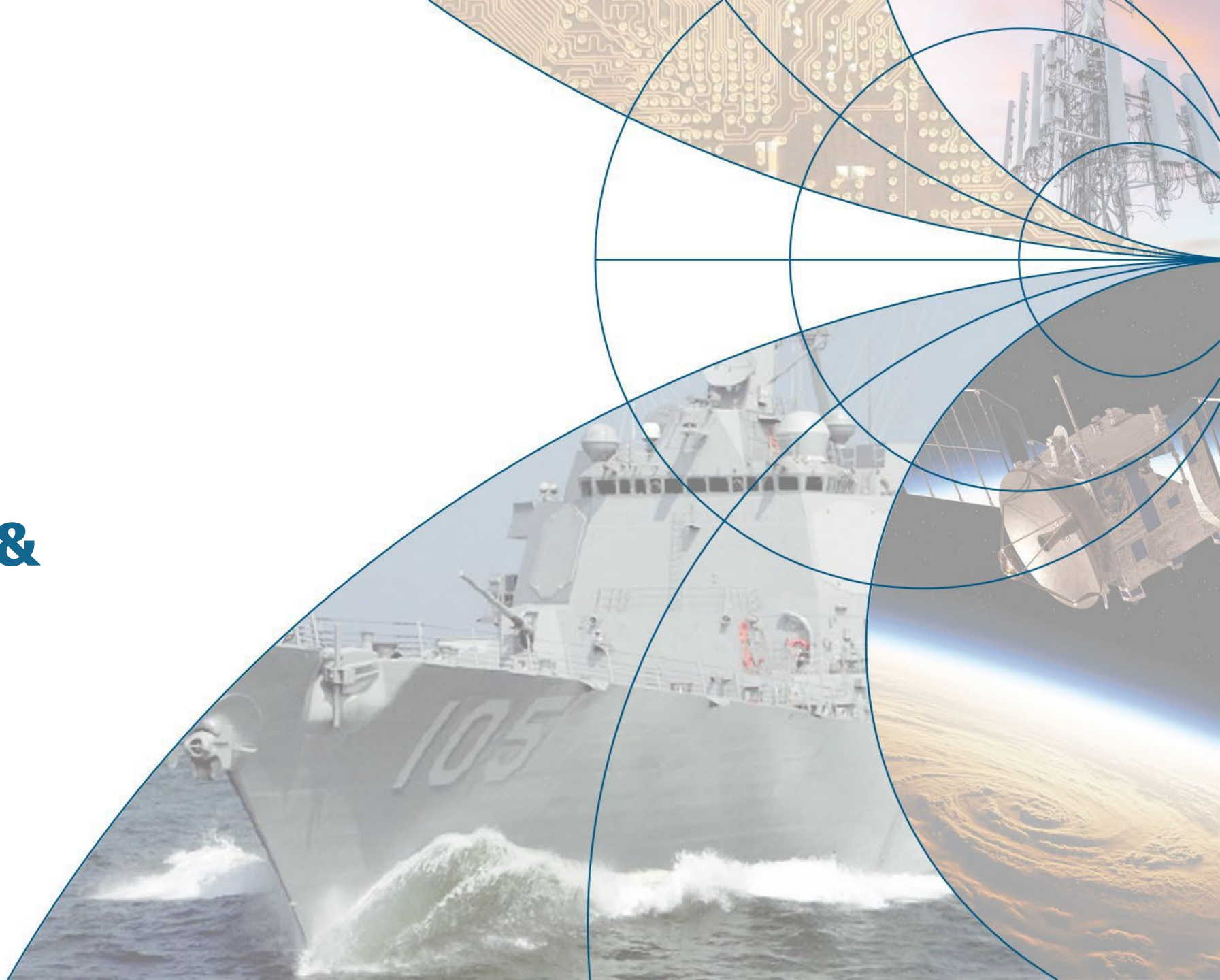

Active Components



Industry leading Logarithmic Amplifiers, Converters, Limiters, Low-Noise Amplifiers (LNAs), Phase Shifters, Solid State Switches, Digital Attenuators, Frequency Sources, Switched Filter Banks, IQ Modulators, and other complex RF solutions

Passive Components



Portfolio includes Limiters, Filters, Couplers, Dividers, Combiners, Hybrids, Monopulse Comparators, equalizers and many more

Integrated Microwave Assemblies (IMAs)

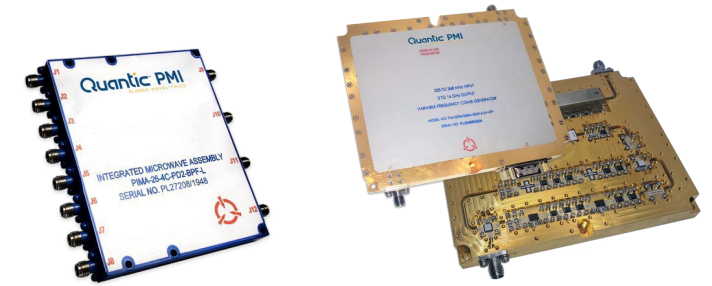

Solutions include RF modules, highly regarded line of frequency downconverters, and other solutions that support challenging national security, aerospace and defense mission-critical applications such as electronic warfare (EW) and signals intelligence (SIGINT)

Products & Services

Solid State Amplifiers

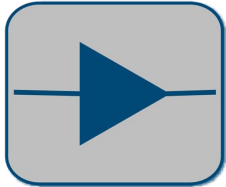

Attenuators (Digital, Analog & Fixed)



Bias Tees

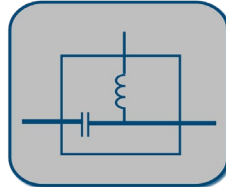

Couplers (90°, 180°, Directional & Pick-off Tees)

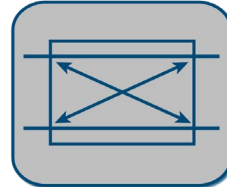

Detectors

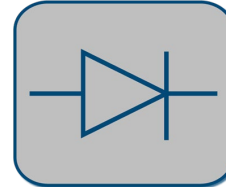

Detector Logarithmic Video Amplifiers

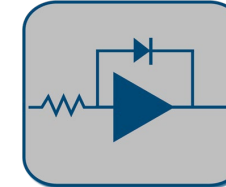

Filters & Switch Filter Banks



Form, Fit, Function Products & Services

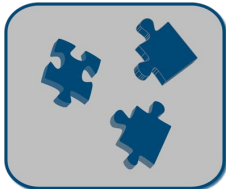

Frequency Converters

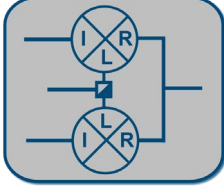

Frequency Discriminators & IFM

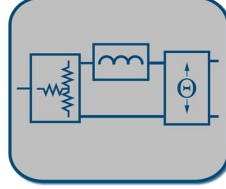

Frequency Sources



Gain & Loss Equalizers

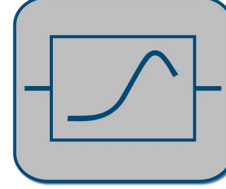

Integrated Microwave Assemblies & Modules

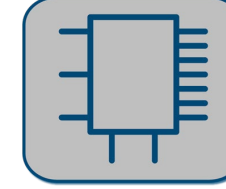

I/Q Vector Modulators

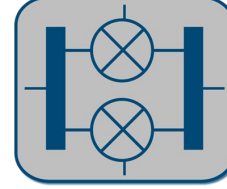

Isolators & Circulators

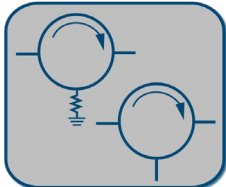

Limiters



Mixers

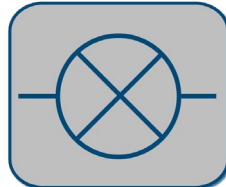

Monopulse Comparators

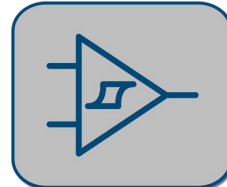

Phase Shifters & Bi-Phase Modulators

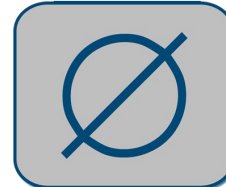

Power Dividers & Combiners

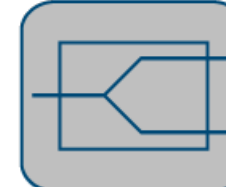

Prescalers & Multipliers

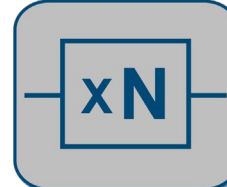

Rack & Chassis Mount Products



Receiver Front Ends & Transceivers

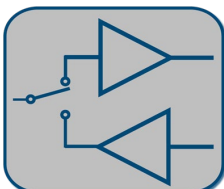

SMT & QFN Products

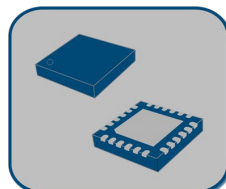

Solid-State Switches

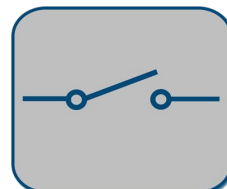

Switch Filter Banks

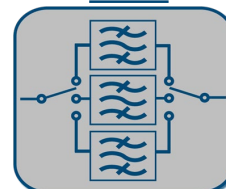

Switch Matrices

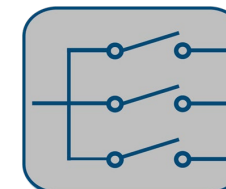

USB Products

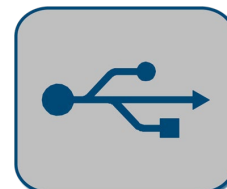

Detector Logarithmic Video Amplifiers

- DLVAs, ERDLVAs, SDLVAs Designs
- Exceptional Temperature Stability, Log Linearity & Frequency Response
- TSS > -68 dBm & Fast Log Video Response Time
- CW Immunity, Temperature Compensation & Matched Sets
- Hermetic Sealing, Military or Aerospace Screening available
- Connectorized or surface mount
- Form, Fit & Function Products & Services
- Custom Designs to Your Specifications



**0.7 to 1.3 GHz
IF Logarithmic
Amplifier (SDLVA)**



**0.1 to 2 GHz
Miniature SDLVA**



**2 to 18 GHz,
65 dB CW
Immune ERDLVA**



**2 to 18 GHz
Successive Detection
Log Video Amplifier
(SDLVA)**



**18 to 40 GHz
DLVA**



**0.5 to 4 GHz
SDLVA**

Switches & Switch Matrices

- Broadband Performance to 70 GHz
- Solid State
- Ultra-High Isolation
- Low Insertion Loss
- Ultra-High Speed
- Low Power Consumption
- SP1T - SP64T (Reflective or Absorptive)
- Connectorized or Surface Mount
- Hermetic Sealing, Military or Aerospace Screening available
- Form, Fit & Function Products & Services
- Custom Designs to Your Specifications



0.1 to 20 GHz
SP4T Absorptive Switch



0.1 to 52 GHz
SP16T Absorptive Switch

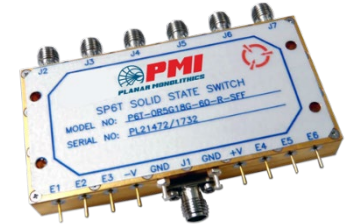

0.5 to 18 GHz
SP6T Reflective Switch



7 to 18 GHz
SP20T Absorptive Switch



0.1 to 44 GHz
SP2T Absorptive Switch



0.1 to 56 GHz
SP2T Absorptive Switch



2 to 18 GHz
SP2T Absorptive Switch



0.1 to 54 GHz
SP8T Absorptive Switch

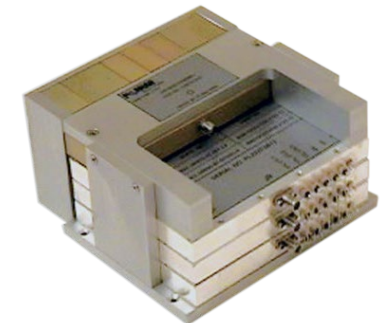

0.02 to 3 GHz, SP8T Switch Matrix Assembly

Solid State Amplifiers

- Low Noise Amplifiers (Broadband, Narrow Band & Multioctave)
- Variable Gain, High IP SIGINT & Limiting Amplifiers
- Coaxial, Power, Test & Lab Use Amplifiers
- Gain & Phase Matching
- Hermetic Sealing, Military or Aerospace Screening available
- Connectorized or surface mount
- Form, Fit & Function Products & Services
- Custom Designs to Your Specifications



2023 **Military-Aerospace Electronics**
Innovators Awards
SILVER HONOREE

2 to 18 GHz
High-Power Amplifier

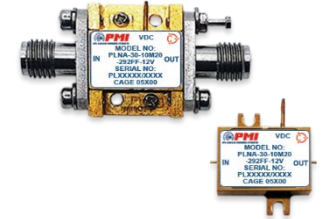

Ultra-Low Noise Amplifier
Dual use component



0.25 to 20 GHz
Low Noise Amplifier



0.5 to 18 GHz
Dual Gain Amplifier



High Linearity,
Low Noise Amplifier



1 to 18 GHz
Portable Amplifier

Limiters

- Broadband Performance to 62 GHz
- High Peak Power Handling
- Fast Recovery & Low RF Leakage
- Low Insertion Loss
- Small Size & Standardized Packaging
- Hermetic Sealing, Military Screening available
- Form, Fit & Function Products & Services
- Custom Designs to Your Specifications



0.1 to 6 GHz
2.5 W CW Limiter



0.01 to 62 GHz
1.5 W CW Limiter



0.02 to 18 GHz,
100 W CW
RF Limiter



1 to 18 GHz,
3 W CW Limiter



32 to 36 GHz 20
W Peak Limiter



26.5 to 40 GHz
20 W Peak Limiter



18 to 40 GHz
2 W Limiter

Filters & Switch Filter Banks

- Low-Pass, High-Pass, Band-Pass, Notch or Bandstop, Duplexers & Multiplexers
- Filter Types: Lumped-Element, Cavity, Compline, Printed, Hairpin, Suspended Substrate, Edge-coupled, Stripline
- Hermetic Sealing, Military or Aerospace Screening available
- Connectorized or surface mount
- Form, Fit & Function Products & Services
- Custom Designs to Your Specifications



Band Pass Filter



1 to 20 GHz
6-Channel Switch Filter Bank



Low Pass Filter with
2.4 GHz Cutoff Frequency



DC to 26 GHz
5-Channel Switch Filter Bank



Double Sided, 100 MHz to 18.0 GHz
6 Channel Switch Filter Bank



Miniature, 2 Channel Switch Filter Bank

Attenuators (Digital, Analog Control & Fixed)

- Ultra-Broadband Performance to 50 GHz
- New Mechanical Attenuator Designs
- High Attenuation Accuracy
- Low Insertion Loss
- Excellent Frequency Flatness
- Analog or Digital Control Available
- High Speed & Very Small Packaging
- Hermetic Sealing, Military or Aerospace Screening available
- Connectorized or surface mount
- Form, Fit & Function Products & Services
- Custom Designs to Your Specifications



1 to 40 GHz
10-Bit Digital Attenuator



1 to 18 GHz
7-Bit Programmable Attenuator



6 to 11 GHz
Mechanical Attenuator



1 to 4 GHz,
Voltage Variable Attenuator



3.1 to 3.5 GHz
Bi-Directional Variable
Attenuator

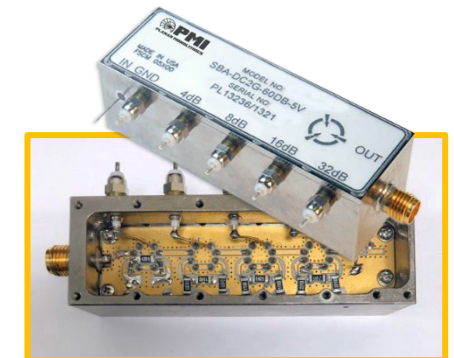

DC to 2 GHz, Electro-mechanical
STEP Attenuator

Phase Shifters

- 0 to 360°
- Broadband to 40 GHz
- Ideal for Industrial & Military Applications
- Analog or Digital Controlled
- Fast Speed & Response
- Low Insertion Loss
- High Phase Accuracy
- Hermetic Sealing, Military or Aerospace Screening available
- Form, Fit & Function Products & Services
- Custom Designs to Your Specifications



8 to 12 GHz, optimized for 10.27 GHz
Digitally Controlled Analog
Phase Shifter



0.1 to 20 GHz, 360°
8-Bit Digital Phase Shifter



2 to 18 GHz
12-Bit Vector Phase Shifter



32 to 37 GHz
8-Bit Digitally Controlled
Phase Shifter



6 to 18 GHz
10-Bit Digitally Controlled
Phase Shifter



2 to 18 GHz
8-Bit Phase Shifter



2 to 8 GHz, 8 Bit, 360°
Digital Phase Shifter

Bi-Phase Modulators

- 90°, 360° Models
- Low Insertion Loss
- Flat Response
- Digital Control
- High Phase Accuracy
- Hermetic Sealing, Military or Aerospace Screening available
- Form, Fit & Function Products & Services
- Custom Designs to Your Specifications



18 to 40 GHz
Bi-Phase Modulator



2 to 18 GHz
Bi-Phase Modulator



2 to 6 GHz
Bi-Phase Modulator/Shifter

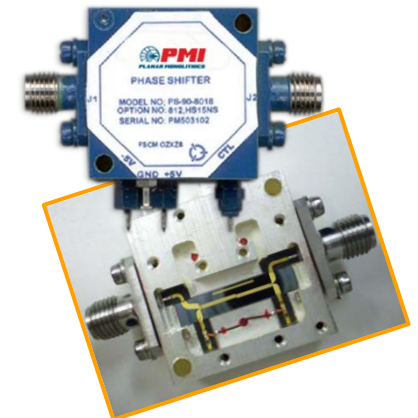

1.1 to 1.12 GHz
180° Bi-Phase
Modulator/Phase Shifter

I/Q Vector Modulators

- Ultra-Broadband Performance to 40 GHz
- High Speed Modulation
- Analog & Digital I/Q Inputs
- Low Spurious Response
- Low Insertion Loss
- High Absolute Phase Accuracy
- Low Current Consumption
- Hermetic Sealing, Military Screening available
- Form, Fit & Function Products & Services
- Custom Designs to Your Specifications

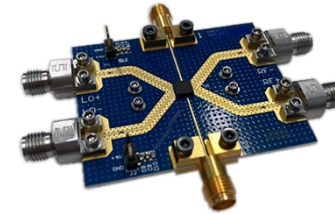

Evaluation Board for PIQ-1-SMT Integrated Broadband IQ Vector Modulator

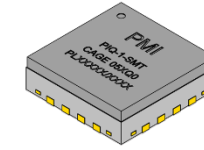

0.1 to 20 GHz Integrated Broadband IQ Vector Modulator



0.5 to 2 GHz, I/Q Vector Modulator



2 to 18 GHz, High Performance I/Q Vector Modulator



0.085 to 18 GHz, I/Q Vector Modulator

Monopulse Comparators

- Frequency coverage up to 36 GHz
- Rugged Coaxial Design
- Low VSWR
- High Power Handling with Minimum Insertion Loss
- High Isolation between Channel Ports for Optimum Phase & Amplitude Balance
- Hermetic Sealing, Military Screening or Aerospace Screening Available
- Form, Fit & Function Products & Services
- Custom Designs to Your Specifications



**14.5 to 15.5 GHz
Monopulse Comparator**



**3 to 3.7 GHz
Monopulse Comparator**



**9.3 to 9.9 GHz
4-Way Phase Divider**



**12 to 13 GHz
Monopulse Comparator**



**20.2 to 21.2 GHz
Monopulse Circuit**

Frequency Converters – BUC / BDC

- Up / Down Converter Designs
- Ideal for Industrial & Military Applications
 - Radar Warning, ECM, ESM & ELINT
 - EW / SIGINT
 - Radar Test Equipment
 - Microwave Radio
 - Instrumentation Modules
- Designed to withstand stringent military ground or airborne environments
- Frequency Coverage up to 40 GHz
- Form, Fit & Function Products & Services



4.4 to 7.8 GHz
Down Converter Module



7.8 to 11.2 GHz
Down Converter Module



11.2 to 14.6 GHz
Down Converter Module



14.6 to 18 GHz
Down Converter Module

Frequency Sources

- Designed for Industrial & Military Applications
 - Radar Warning, ECM, ESM & ELINT
 - EW / SIGINT
 - Radar Test Equipment
 - Microwave Radio
 - Instrumentation Modules
- Synthesizers, DTOs, PLOs, PLDROs, DROs, VCOs, OCXOs, Cos types available
- All models can withstand stringent military ground or airborne environments
- Frequency Coverage up to 40 GHz
- High Level of Frequency Accuracy
- Linearized Frequency Tuning
- Low Frequency Drift, Phase Noise & Harmonic Content
- Internal Digital Calibration
- Temperature Compensation
- Form, Fit & Function Products & Services



8.8 to 9.46 GHz
Temperature Stabilized Output
Medium Power X-Band Gunn-
Effect Oscillator



2 to 18 GHz,
Digitally Tuned Oscillator (DTO)



Digitally Tuned
Oscillators (DTOs)



Phase Locked Oscillator (PLDRO)
ROHS Compliant



6 to 18 GHz, Synthesizer



10 MHz Reference
Source



10 GHz, Integrated Phase
Shifter Dielectric Resonator
Oscillator (DRO) Module



840 MHz
Phase-Locked Oscillator

Gain & Loss Equalizers

- Ideal for Equalizing Cable Loss or Gain Flatness
- Narrow-bandwidths or broadband up to 40 GHz
- Low Insertion Loss & VSWR
- Various frequency equalization values
- Multiple and Custom slope characteristics
- Surface Mount or Connectorized
- Hermetic Sealing, Military or Aerospace Screening Available
- Form, Fit & Function Products & Services
- Custom Designs to Your Specifications



26.5 to 40 GHz, 1.5 dB
Passive Amplitude Equalizer



17.6 to 21.6 GHz, 12 dB
Passive Amplitude Equalizer

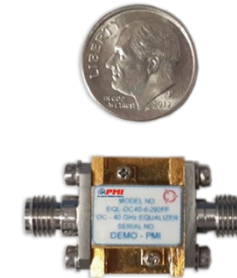

DC to 40 GHz
Passive Equalizer



DC to 20 GHz
Passive Equalizer

Detectors - Diode, Directional, Threshold



- Broadband Frequency coverage to 40 GHz
- Low VSWR & Insertion Loss
- Excellent Frequency Flatness
- Small Package Size
- Hermetic Sealing, Military or Aerospace Screening available
- Form, Fit & Function Products & Services
- Custom Designs to Your Specifications



0.01 to 18 GHz
Low Noise Tunnel
Diode Detector



0.5 to 18 GHz, High Speed,
High Sensitivity Diode Detector



18 to 40 GHz, Low Noise,
Tunnel Diode Detector



4 to 26.5 GHz,
Zero Bias Schottky Detector



6 to 18 GHz
Biased Schottky Diode Detector



2 to 18 GHz, High Speed,
High Sensitivity Diode Detector

Couplers – 90°, 180°, Directional & Bi-Directional

- Broadband Response
- High Isolation
- Excellent Phase & Amplitude Balance
- Small Package Size
- Hermetic Sealing, Military or Aerospace Screening available
- Form, Fit & Function Products & Services
- Custom Designs to Your Specifications



DC to 18.0 GHz
Directional Coupler

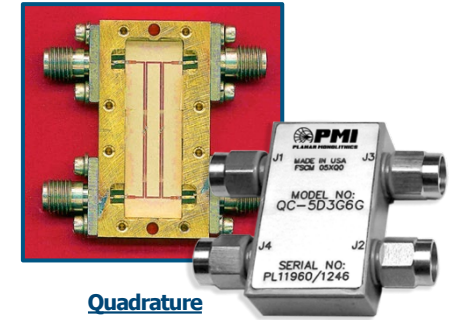

Quadrature
Couplers



5 to 10 GHz
Hybrid Coupler



8 to 11 GHz
Directional Coupler



High Power
Quadrature Hybrid Coupler



90° Hybrid Coupler

Power Dividers/ Combiners (Passive & Active)

- Designs for Commercial, Military & Aerospace Applications
- Low Loss & High Isolation
- Excellent Amplitude & Phase Balance
- 2-Way to 16-Way Configurations
- Broadband Frequency coverage to 50 GHz
- Hermetic Sealing, Military or Aerospace Screening available
- Form, Fit & Function Products & Services
- Custom Designs to Your Specifications



**18 to 40 GHz
2-Way Power Divider**



**2 to 20 GHz
8-Way Power Divider**



0.02 to 6 GHz, Amplified 4-Way Power Divider

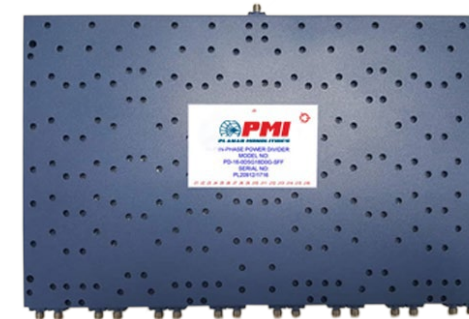

**0.5 to 18 GHz
16-Way Power Divider**



**2 to 26 GHz
4-Way Power Divider**



**0.5 to 18 GHz
16-Way Power Divider**



**4.4 to 18 GHz, SMPM
4-Way Power Divider**



**0.1 GHz, Amplified
8-Way Power Divider**

Rack and Chassis Mount Products

- Designs for Commercial, Military & Aerospace Applications
- Supplied in Ruggedized, 1U to 6U chassis
- A mixed set of functions:
 - Amplification
 - Attenuation (Digital Solid-State)
 - Switching (Ultra High Speed)
 - Power Detection / Fault Detection
 - Phase Shifting / Phase Modulation
 - Pulse Modulation / Noise Generation
 - RF Filtering / RF Limiting
 - Power Splitting
 - RF Signal Distribution
- Form, Fit & Function Products & Services
- Custom Designs to Your Specifications



Ethernet Microcontroller Test Box



Multiagent Radio Frequency Path Simulator



10 MHz to 6 GHz, High Gain Amplifier
Integrated Microwave Assembly



RF Signal Distribution Systems



0.1 to 18 GHz High Gain Amplifier
Integrated Microwave Assembly



10-Way Switch Filter Bank



0.5 to 18 GHz
16-Way Power Divider

Frequency Discriminators & IFM

- Designed for Industrial & Military Applications
 - Radar Warning (RW)
 - Electronic Countermeasures (ECM)
 - Electronic Support Measures (ESM)
 - Electronic Intelligence (ELINT) Applications
- Digital or Analog Outputs
- Narrow & Broadband Frequency Coverage up to 18 GHz
- Hermetic Sealing, Military or Aerospace Screening available
- Form, Fit & Function Products & Services
- Custom Designs to Your Specifications



30 MHz, Frequency Discriminator



2 to 18 GHz Digital Frequency Discriminator



1 GHz, Frequency Discriminator



3.1 to 3.5 GHz Frequency Discriminator



1 to 18 GHz, Frequency Discriminator

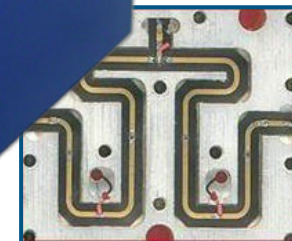

Delay Line in a Frequency Discriminator

USB Products

- Broadband Performance to 40 GHz
- Low Noise Amplifiers, Variable Attenuators & Switch Designs available
- Low Insertion Loss
- All Models use Standard USB 2.0 port
- SMA or 2.92mm Female Connectors
- Hermetic Sealing, Military or Aerospace Screening available
- Form, Fit & Function Products & Services
- Custom Designs to Your Specifications



0.05 to 18 GHz, 12 dB Gain
USB Powered LNA



0.05 to 40 GHz, 12 dB Gain
USB Powered LNA



0.1 to 18 GHz, 30 dB
USB Attenuator



0.1 to 40 GHz, 30 dB
USB Attenuator



0.5 to 18 GHz USB
Powered SP2T Switch



0.5 to 40 GHz USB
Powered SP2T Switch

SMT & QFN Products

- PMI offers Surface mount (SMT) & QFN packaging for many types of devices....SDLVA's, Log Amplifiers, Phase Shifters, Attenuators, Switches, as well as Low Noise Amplifiers.
- Multifunction options available in a single QFN package such as Limiters / LNA or LNA / Detectors.
- Custom devices that meet your specific control function can be designed & integrated into specified packaging with the required testing.



**0.1 to 2 GHz
Miniature SDLVA**

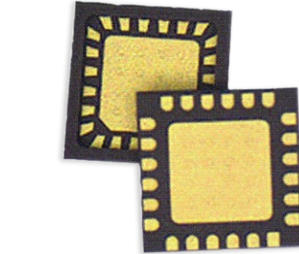

**14.4 to 15.4 GHz
RF Limiter & Low Noise Amplifier**

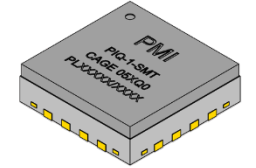

**0.1 to 20 GHz
Integrated Broadband
IQ Vector Modulator**

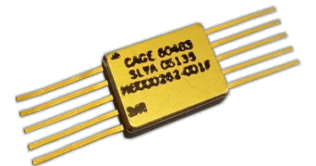

**0.6 to 1.35 GHz
Miniature SDLVA**



**0.01 to 62 GHz
High Power Limiter**

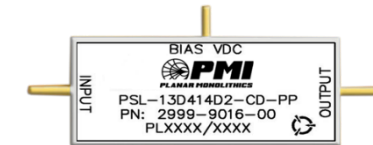

**13.4 to 14.2 GHz
High Power Switch Limiter**



**DC to 20 GHz
Equalizer**



**18.0 to 40 GHz
High Power Limiter**



**0.1 to 2 GHz
Miniature SDLVA**



**14.4 to 15.4 GHz
High Power SPST Switch**

Integrated MIC/MMIC Modules & Assemblies (IMAs)

- Broadband to 50 GHz
- Built to your specifications with functions:
 - Amplification
 - Attenuation
 - Filtering
 - Frequency Discrimination
 - Switching
 - Phase Shifting
 - Power Detection
 - Modulation/Demodulation
 - Coupling
 - Limiting
 - Digital/Analog Control
- Hermetic Sealing, Military Screening available
- Form, Fit & Function Products & Services
- Build to Print or Built to your SCD



0.5 to 18 GHz, Custom Phase ($\pm 10^\circ$) & Amplitude (± 1.5 dB) Matched Integrated Modules/Assemblies



2.6 to 5.2 GHz 8 Channel Selectable LO Frequency Source



10 GHz, Integrated Phase Shifter and Dielectric Resonator Oscillator (DRO) Module(Inside)

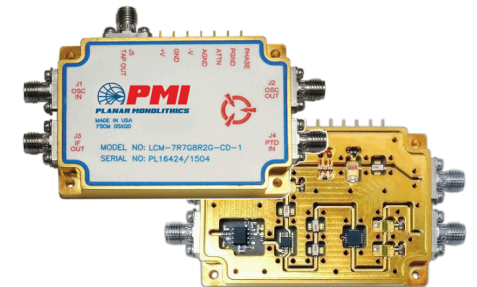

7.7 to 8.2 GHz Laser Control Module



0.1 to 18 GHz Transceiver (Phase II)

Integrated MIC/MMIC Modules & Assemblies (IMAs)



2021 **Military & Aerospace Electronics** Innovators Awards
PLATINUM HONOREE



1 to 18 GHz Channelized Receiver

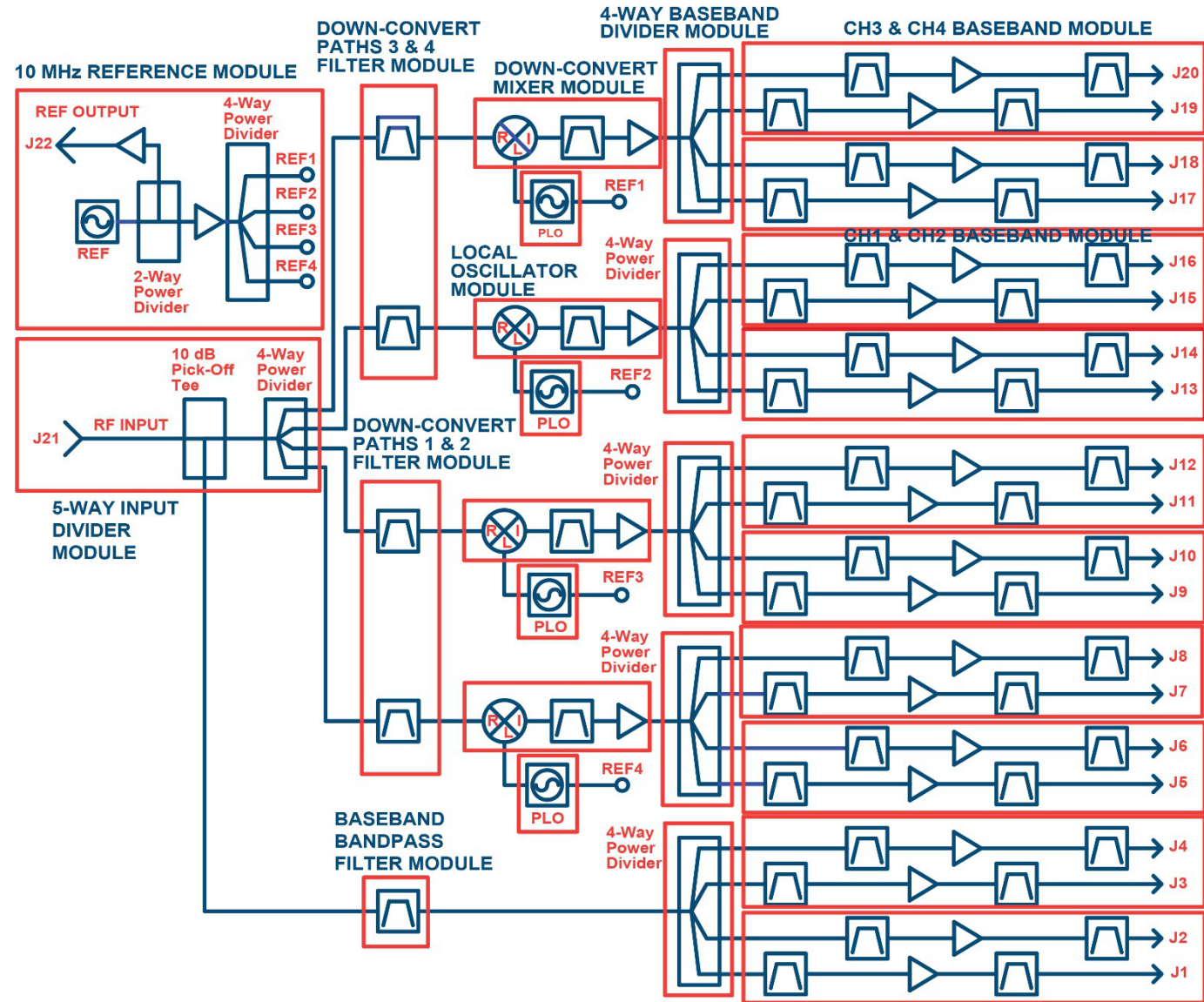

Receiver Front End & Transceiver Products

- Designs for Commercial, Military & Aerospace Applications
- Broadband Frequency coverage to 50 GHz
- Hermetic Sealing, Military or Aerospace Screening available
- Form, Fit & Function Products & Services
- Hermetic Sealing, Military or Aerospace Screening available
- Form, Fit & Function Products & Services
- Custom Designs to Your Specifications



**2 to 18 GHz
Direction Finding Receiver Front End**



**0.1 to 18 GHz
Transceiver (Phase II)**

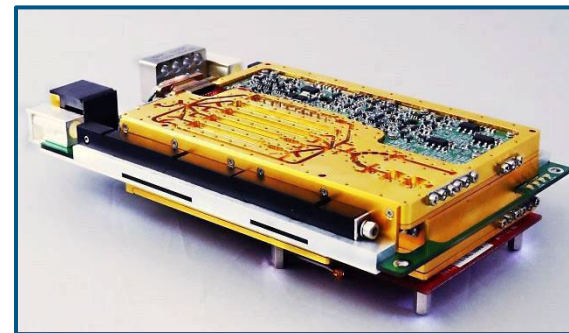

0.1 to 18 GHz Transceiver (Phase III)



0.1 to 18 GHz Transceiver Unit

Receiver Front End & Transceiver Products



100 MHz to 18 GHz Transceiver

- Integrated Up and Down Converters
- IF up to 4 GHz
- Time Gated SDLVA for Pulse Blanking
- -80 to -10 dBm Input Dynamic Range
- Customizable Switch Filter Banks
- 0 to 10 dBm Transmit Power
- 100 ns Switching Speed
- Fits into a 3U open VPX form factor utilizing the high-speed VITA 67 RF connector
- CW Immunity

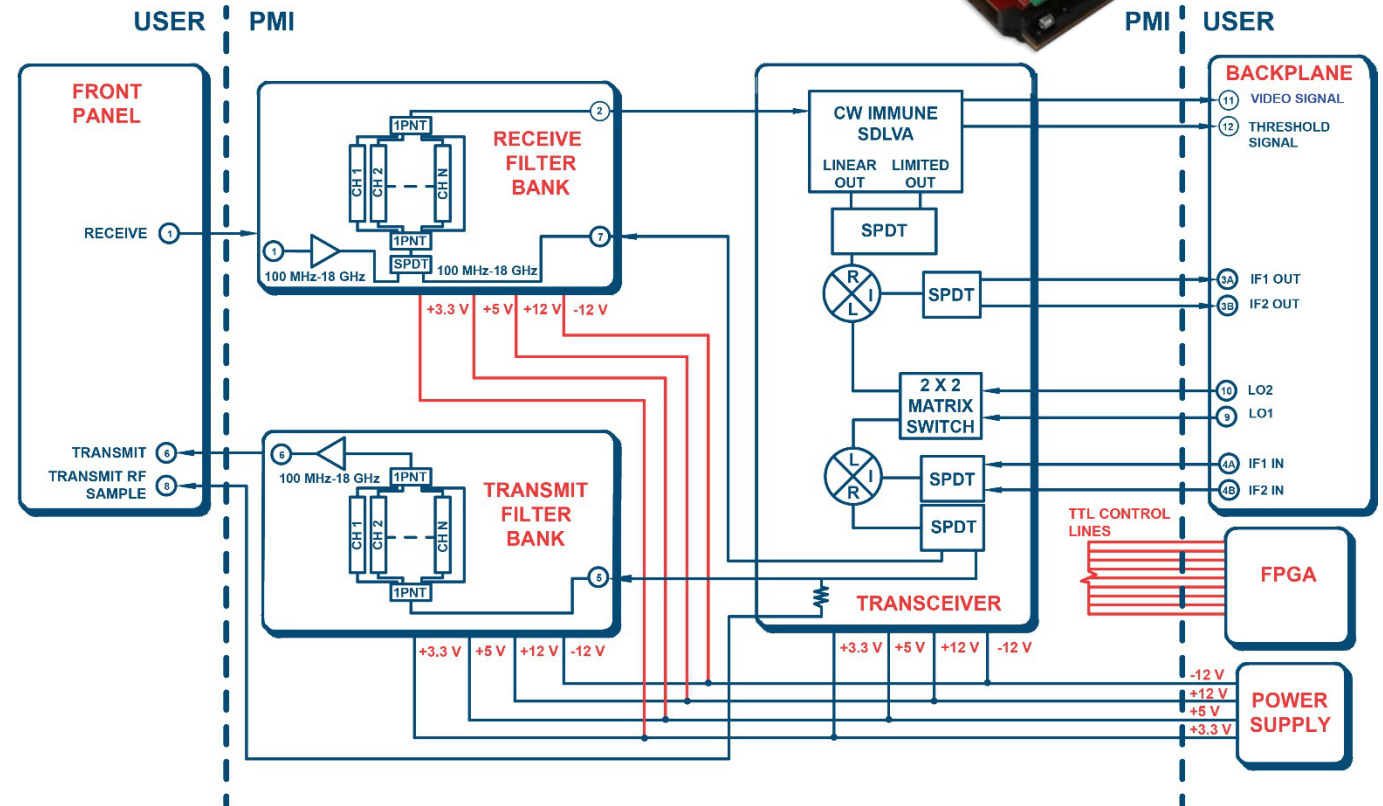
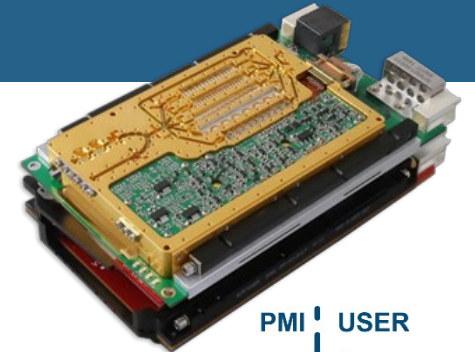

Receiver Front End & Transceiver Products

Bias Tees

Standard three-port network for high current applications

- Designed to your application specific requirements covering frequency ranges to 70 GHz
- Features include high power handling, low insertion loss & excellent return loss
- Hermetic Sealing, Military or Aerospace Screening available

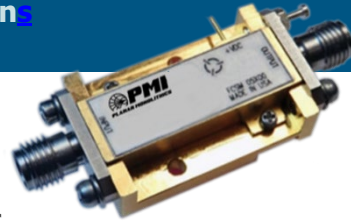

Passive & Active Mixers

Designed for form, fit, function applications

- Active, Double Balanced, Image Reject, I/Q designs available in connectorized or surface mount
- Designs to fit communication systems, satellite, radio transceivers, test & measurement applications
- Hermetic Sealing, Military or Aerospace Screening available



Isolators & Circulators

Coaxial or Surface Mount Configurations

- Customized designs for mobile communications, military, radar & satellite communications applications
- Features include broadband frequency coverage, excellent isolation, low insertion loss & rugged construction
- Hermetic Sealing, Military or Aerospace Screening available



Prescalers & Multipliers

Custom Designed to Your Specifications

- Designs for satellite communications, point-to-point & point-to-multipoint radios, military & space applications
- Broadband frequency coverage, specify divide by ratio, & low SSB phase noise
- Hermetic Sealing, Military or Aerospace Screening available



In-Stock / COTS Products – Same Day Shipping



Same Day Shipping!

Select PMI products are available from stock that can be shipped from PMI directly or one of its authorized distributors:



<https://www.pmi-rf.com/stock-items>

LM-118-100W-22DBM Active

RF Limiter

Buy Now

PMI Model LM-118-100W-22DBM is an RF Limiter that operates in the range of frequencies from 1 to 18 GHz that can handle up to 100 W maximum; a low insertion loss of 0.5 dB maximum; a low insertion loss of 0.9" x 0.38" x 0.38" with SMA connectors. The leakage power is 22 dBm maximum. Recovery time is 10 ns. Package size is 1.8" x 0.38" x 0.38".

Product Specifications

General Parameters:

Status: Active

Request a Quote

Product Feature

Additional Documents

- Product Feature
- Test Report - 9/11/24
- S-Parameters
- 3D Model

Part Number	Availability	Size	Frequency Max	Frequency Min	Status
FD-0518-10-012	Buy Now	2.00" x 1.02" x 0.50"	12 GHz	0 GHz	Active

Part Number	Availability	Input Power	Input/Output VSWR	Insertion Loss	Frequency Max	Frequency Min	Status
LM-218-14-200W-SMF *	Buy Now	1 W CW	2.0:1 max.	2.0 dB max. @ Pin +10 dBm	18.0 GHz	2.0 GHz	Active
LM-6G18G-15-10W-SFF *	Buy Now						Active
LM-1018G-16-4W-SMF	Buy Now						Active
LM-218-14-200W-SMF-HERM *	Buy Now	1 W CW	2.0:1 max.	2.0 dB Maximum	18 GHz	2 GHz	Active
LM-300M16-21-50W-SFF	Buy Now	+54 dBm CW Max (250 W) Peak Power 360 W Pulse 2 ms, 10% Duty Cycle	2:1 Max		1.0 GHz	0.3 GHz	Active
LM-10M370-150DBM-10W-AGAL	Buy Now	50 Watts Peak Max (0.02 to 12 GHz) 40 Watts Peak Max (18 GHz) (1 μs Pk, 1% Duty Cycle)	1.8:1 Max	0.01 to 0.8 GHz: 1.00 dB Max 8 to 18 GHz: 2.00 dB Max 18 to 30 GHz: 2.70 dB Max 30 to 37 GHz: 4.30 dB Max	37.0 GHz	0.01 GHz	Active
LM-10M120-20-10W-SFF	Buy Now	+40 dBm CW Max Peak Power 100 W Pulse 1 μs 1% Duty Cycle	2:1 Max	2 dB Max	12.0 GHz	0.01 GHz	Active
LM-0518-10-1W-SHS-1-F *	Buy Now	1 Watt CW, 100 Watts Peak, 1 μs Pulse, 0.1% Duty Cycle, Operated to 20% at 125 °C	2.0:1 Max	2.0 dB Max, 1.5 dB Typ	18 GHz	0.5 GHz	Active

Our Partners





Facilities

Frederick, MD & El Dorado Hills, CA



7309-A Grove Road, Frederick, MD:

- 20,000 sq. ft. Facility
- 7,500 sq. ft. Class 10,000 ppm Clean Room for Assembly, Test, ESS & Inventory
- 4,000 sq. ft. Engineering Space
- 2,800 sq. ft. Office space and Conference rooms
- 2,500 sq. ft. Machine Shop, Paint Booth, and Random Vibration/Shock Testing
- 2,200 sq. ft. Communal areas (2 breakrooms, restrooms, and lobby)
- 1,000 sq. ft. Accounting, Human Resources and Sales & Marketing
- Components & Sub-Assembly Manufacturing
- Hybrid Assembly
- Engineering & Test Departments
- QA/QC, Sales, Marketing & Executive Offices
- 3 Conference Rooms (Production, Engineering and S&M)

4921 Robert J. Mathews Pkwy, El Dorado Hills, CA:

- 5,100 sq. ft. Facility
- Components Manufacturing
- Hybrid Assembly
- Test and Engineering Departments
- Production and Quality Departments
- EOL and Obsolete Aftermarket Manufacturing

East Coast Operations



East Coast Operations

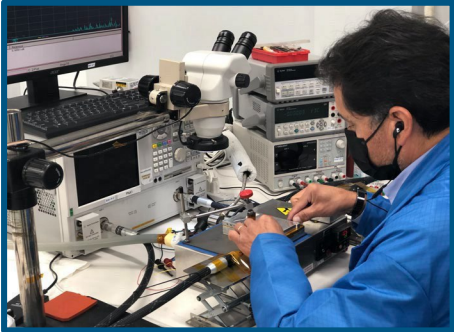

East Coast Operations

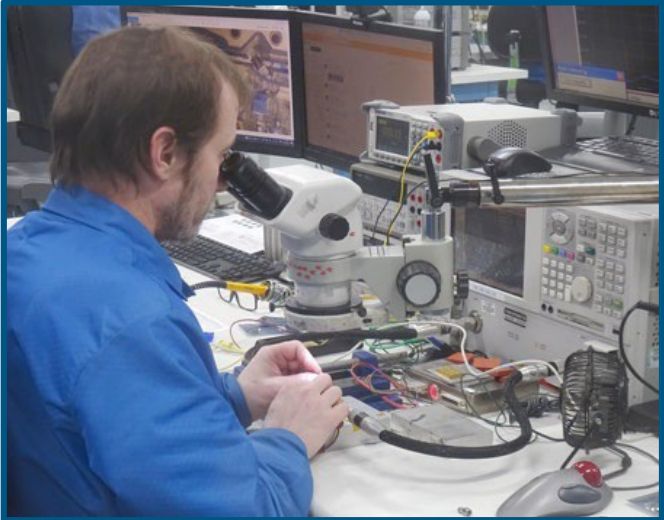

East Coast Operations

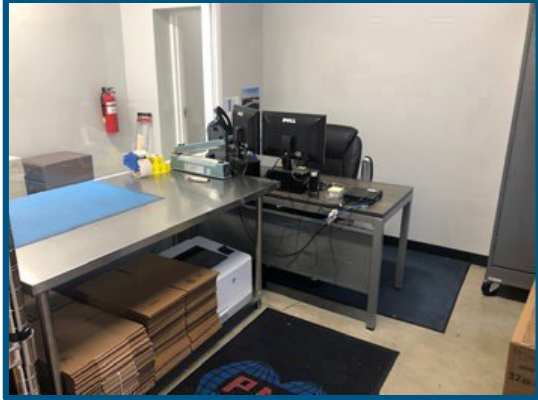

East Coast Operations

Production & Test

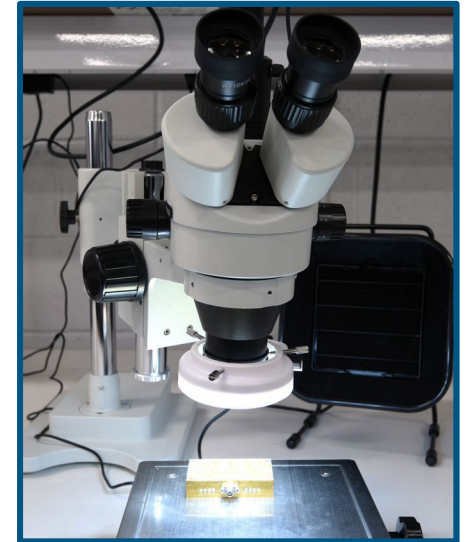

East Coast Operations



Cycle Chamber & High Power SSPAs



East Coast Operations



Engineering

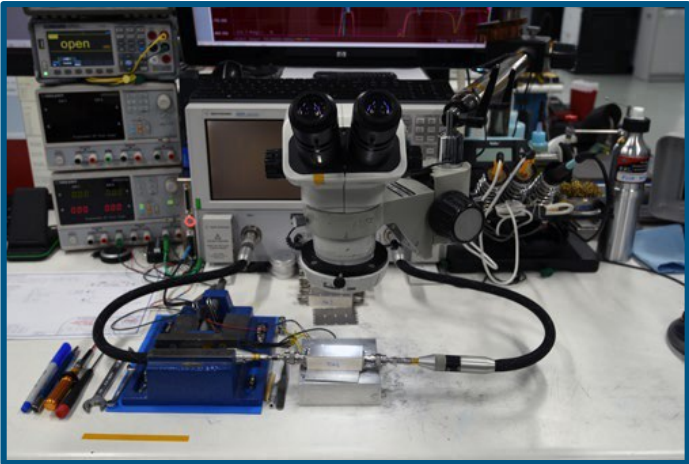
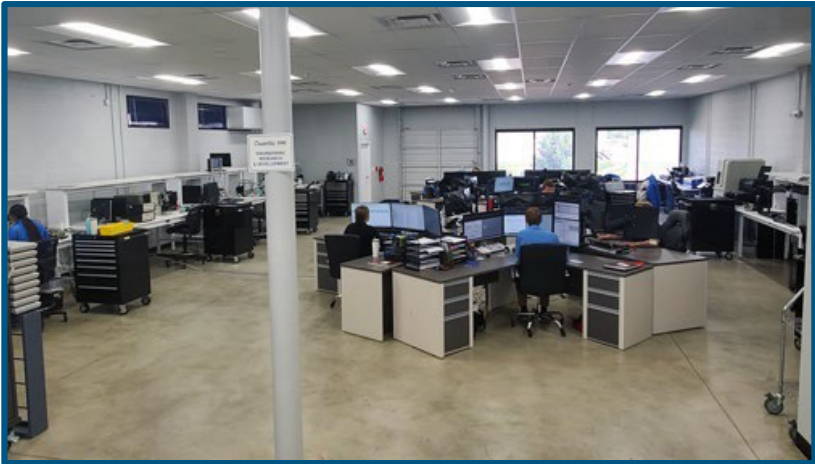
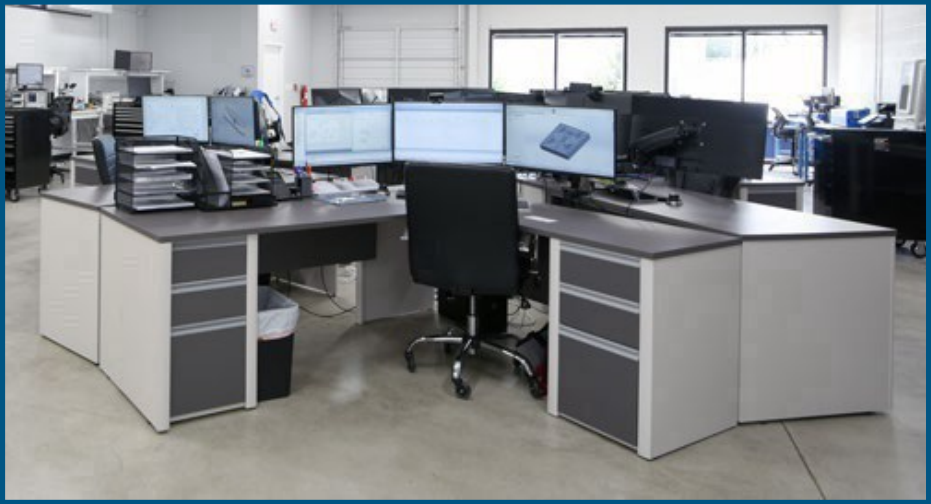
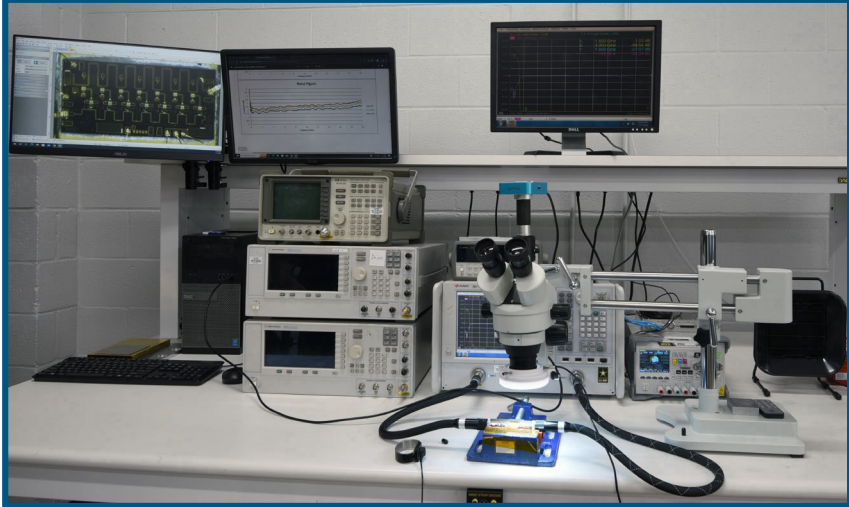

East Coast Operations



Hermetic Laser Welder



Thermal Shock



Thermal Shock



UV Curing Light Printer

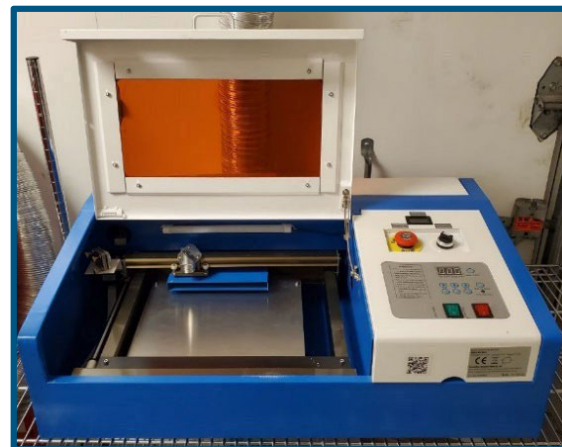

CO₂ Laser



Hot/Cold Plate



Random Vibration

East Coast Operations



Cycling Chamber



Plasma Cleaner



20 W Fiber Laser Engraver

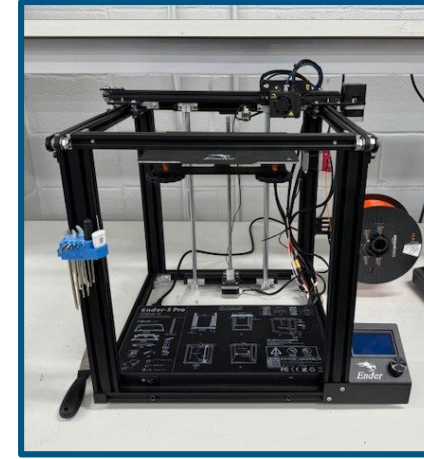

Ender-5 Pro 3D Printer



Metallurgic Microscope



Hermetic Package Testing



Cleanroom Ovens



X1-Carbon 3D Printer



RF Probe Station up to 67 GHz



Shock Testing

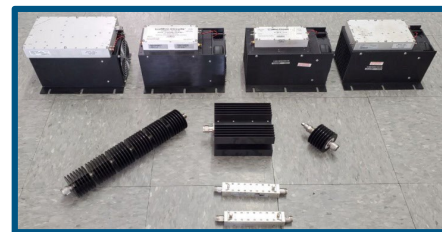

High Power Testing

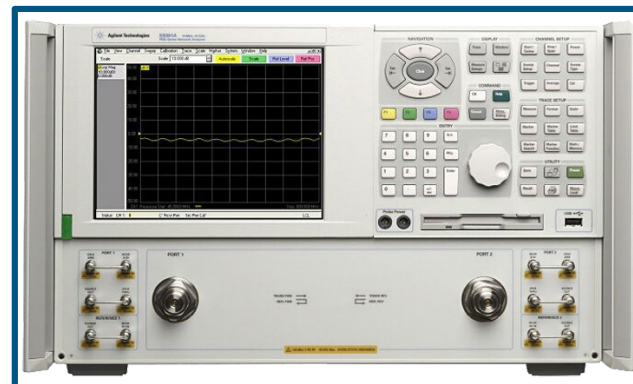

East Coast Operations

Precision Machine Shop



HAAS DT1 CNC Milling Machine



East Coast Operations

Precision Machine Shop



Mazak Nexus 430A-II CNC Milling Machine



Network Analyzers:

- (1) HP 30 kHz-6 GHz Network Analyzer
- (1) Keysight 9 kHz - 20 GHz PNA
- (4) Agilent 10 MHz - 20 GHz PNA
- (7) Agilent 10 MHz - 40 GHz PNA
- (1) Agilent 10 MHz - 43.5 GHz PNA
- (8) Agilent 10 MHz - 50 GHz PNA
- (1) Agilent 10 MHz - 67 GHz PNA
- (5) Agilent 10 MHz - 40 GHz E-CAL
- (1) Agilent 10 MHz - 50 GHz E-CAL
- (1) Agilent 10 MHz - 67 GHz E-CAL
- (7) Rohde & Schwarz VNAs

Noise Figure Meter:

- (2) Agilent N8975A (10 MHz to 26.5 GHz) & Downconverter (40 GHz)
- (1) HP 8970B
- (4) Keysight Noise Sources

Oscilloscopes:

- (1) Tektronix TDS210
- (1) Tektronix TDS2024C
- (1) Agilent DS06034A
- (1) Keysight DSOS204A
- (6) Agilent DSOX3034A
- (2) LeCroy WaveJet 314A

- (1) Agilent MSOX3034A
- (1) Keysight MXK608A
- (1) Siglent D5D6000
- (1) Keysight EXR258A

Power Amplifiers:

- (1) Varian TWTA 7 – 18 GHz, 20 W
- (1) CPI TWT Amplifier (2-8 & 8-18 GHz) 300 W CW
- (1) MC (3 - 3.5 GHz) 100 W
- (1) MC (800 – 1000 MHz) 100 W
- (1) MC (20 - 512 MHz) 25 - 50 W
- (1) MC (20-500 MHz) 100 W
- (1) Spanawave GT-1051B Power Amplifier, 10 MHz to 50 GHz, 0.5 W to 40 GHz, 0.4 V to 50 GHz
- (2) Ophir (20 - 1000 MHz & 700 - 6000 MHz) 120W High Power Amplifier
- (1) Mini-Circuits 2.4 - 2.5GHz, 1kW Generator

Power Meter:

- (5) Gigatronics 8541B/C, 8542C
- (4) Agilent E4418B
- (1) Agilent N1913A
- (3) Spanawave 8652A

Pulse/Signal Generators:

- (1) Anritsu MG3692B Signal Generator
- (1) HP 8015A Pulse Generator

- (1) HP 8013B Pulse Generator
- (1) HP 8012B Pulse Generator
- (1) HP 8350B Sweep Oscillator
- (1) HP Arbitrary Waveform Generator 33120A
- (1) HP 8664A Signal Generator
- (2) Wavetek Model 801 Pulse Generator
- (2) HP 8673D Signal Generator
- (2) Agilent 33522A Arbitrary Waveform Generator
- (4) Keysight E8257A PSG Analog Signal Generator
- (6) Keysight E8257D PSG Analog Signal Generator
- (1) Siglent SDG1062X & Siglent SDG1032X Waveform Generators
- (2) Berkely Nucleonics Pulse Generator
- (2) Agilent 8257C PSG Analog Signal Generator
- (2) Agilent N5183A Signal Generator (100 kHz to 6 GHz)
- (2) Agilent N5181A Signal Generator (100 kHz to 6 GHz)

Spectrum Analyzer:

- (1) HP 8593E Spectrum Analyzer (9 kHz to 22 GHz)
- (2) HP E4448A PSA Spectrum Analyzer (3 Hz to 50 GHz)
- (2) Keysight N9030A Spectrum Analyzer (3 Hz to 50 GHz)
- (2) Keysight 8563E Spectrum Analyzer (9 kHz to 26.5 GHz)

East Coast Operations - Equipment & Standards



Manufacturing Equipment:

- (1) Everbeing C-6 Analytical Probe Station, up to 67 GHz
- (1) ESPEC TSE-12A Thermal Shock Chamber
- (1) TSE-11-A ESPEC Thermal Shock Chamber
- (1) ESPEC BTZ-175 Thermal Cycle Chamber
- (1) LAB SD10 Shock Tower
- (1) JEN410 IR Reflow Oven
- (3) Thermo Electron Oven
- (2) Anatech Plasma Cleaner
- (2) Metallurgical Microscope MT1000
- (1) Westbond 7KE Ribbon Bonder
- (1) Westbond 7KE Ball Bonder
- (1) Westbond 7473E Die Bonder
- (4) Westbond 747677E-79 Convertible Wire Bonder
- (1) Westbond 7476E-79 Wedge Wire Bonder
- (1) Westbond 747630E-79 Wedge Wire Bonder
- (1) Westbond 7400A Wedge Wire Bonder
- (2) Westbond Bond Pull Center
- (1) Dage Bond Puller / Die Shear
- (3) HAAS DT1 CNC Milling Machine
- (1) Mazak Nexus 430A-II CNC Milling Machine
- (1) Mazak VC-EZ16 CNC Milling Machine
- (1) Hardinge Turret Lathe
- (1) Di-Acro Power Shear

- (12) ESS Thermal Hot/Cold Plates
- (1) Ling Dynamic V650 Random Vibration Setup
- (1) Varian Helium Leak Tester
- (1) HANS-G20 20 W Fiber Laser
- (1) Hermetic Package Tester
- (1) UV Curing Light Printer
- (1) Hermetic Laser Welder
- (1) KH-3020 CO2 Laser
- (1) Remco Machined Parts Cleaner
- (1) Bambu Lab X1-Carbon 3D Printer
- (1) Ender-5 Pro 3D Printer
- (6) Quincy Lab Oven

Software:

- Keysight - Genesys S/Filter Synthesis and Simulation
- Ansys – HFSS, High Frequency Structural Simulator
- Exact MAX – MRP/ERP Software
- AutoCAD
- Altium Designer
- Microwave Office
- SolidWorks
- Gibbs Cam
- Draftsight
- Agilent Vee Pro Test Software

Standards:

- ISO9001:2015
- MIL-STD-454
- MIL-STD-202
- MIL-STD-883
- MIL-E-5400
- MIL-I-45208
- IPC-A-610 Workmanship Standard
- IPC-J-STD-001 Soldering Standard
- MIL-STD-45662 Calibration Standard
- AS9100D

West Coast Operations

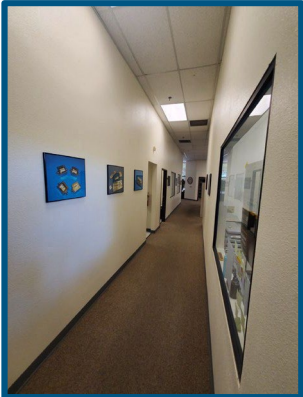

West Coast Operations



West Coast Operations

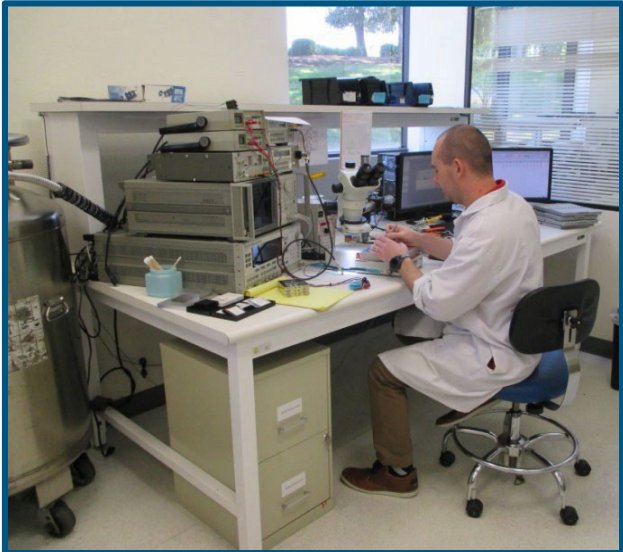

West Coast Operations



Network & Spectrum Analyzers:

- (1) Agilent N5230C PNA Network Analyzer
10 MHz - 20 GHz (Mixer Option)
- (8) HP 8757D Scalar Analyzers
- (1) HP 8720D Network Analyzer (50 MHz – 20 GHz)
- (1) HP 8565E Spectrum Analyzer (50 GHz)
- (1) HP 8592L Spectrum Analyzer
- (2) Keysight E8364B PNA Network Analyzer
(10 MHz - 50 GHz)
- (1) Agilent N4693 E-CAL (10 MHz - 50 GHz)
- (1) R&S FSR40N Spectrum Analyzer

Noise Figure Meters:

- (1) Keysight N4002A Noise Source
- (1) HP 8975A Noise Meter

Power Meters:

- (3) HP EPM-442 Power Meter
- (1) HP E4412A Power Meter
- (1) HP 437B Power Meter
- (1) HP 437A Power Meter

Pulse/Signal Generators:

- (1) HP 83731B Signal Generator
- (4) HP 83620A Signal Generator
- (1) HP 8013B Pulse Generator
- (6) HP 83620A Sweep Generators

- (1) HP 83650 Signal Generator
- (1) Agilent E8257 Signal Generator
- (1) Agilent 83732 Signal Generator
- (1) HP 83623 Sweeper
- (1) Agilent 83640 Sweep Generator
- (1) HP 83620 Sweeper

Oscilloscopes:

- (1) Keysight MSO-X-3054A 500 MHz BW
- (1) Tektronix 2246 100 MHz BW
- (1) Rigol DS1202Z-E
- (2) Agilent DSOX3034A

Manufacturing Equipment:

- (1) Blue M Stable Therm Oven
- (1) Branson 821D Ultrasonic Cleaner
- (2) UNITEK Gap Welders
- (1) Anatech Plasma Cleaner/Etcher
- (3) Westbond 7400A Wedge Bonders
- (1) Westbond 8850 Bond Pull Center
- (3) Westbond 1200A Die Attach Stations
- (1) Westbond 8850 Ball Bonder
- (1) Westbond 7600B Ribbon Bonder
- (7) ESS Chroma Hot and Cold Plates
- (1) ESDEC TSE-12A Thermal Shock Chamber
- (1) Cycle Chamber

Software:

- Keysight - Genesys S/Filter Synthesis and Simulation
- Ansys – HFSS, High Frequency Structural Simulator
- Exact MAX – MRP/ERP Software
- AutoCAD 2005
- AutoCAD 2013
- Gibbs Cam

Standards:

- ISO9001
- MIL-STD-454
- MIL-STD-202
- MIL-STD-883
- MIL-E-5400
- MIL-I-45208
- IPC-A-610 Workmanship Standard
- IPC-J-STD-001 Soldering Standard
- MIL-STD-45662 Calibration Standard
- AS9100

- Equipment Calibration - ISO 17025 Standard with traceability to NIST
- Trained and Experienced ITAR/Export Administrator
- Export Compliance Manual
- AES (Automated Export System) certified export staff
- Long Term Relationships with both DDTTC and SNAP-R Personnel
- NIST SP 800-171 and DFARS 252.204-7012 Compliant
- U.S. Government Registration Numbers:
 - Cage Code: 05XQ0 (East Coast)
 - Cage Code: 71A34 (West Coast)
 - DUNS Number: 829998517
 - SAM (CCR) Registration: 1998E211401
 - Federal Tax ID (TIN): 52-1756966
 - DDTTC Registrant Code: M16913
- Able to support DoD contracts

ISO9001, AS9100D & ITAR Registrations



This Certificate of Registration acknowledges

Planar Monolithics Industries
Planar Monolithics Industries Inc.
dba Quantic PMI
(Central Function)

7309-A Grove Road
Frederick, Maryland 21704
United States

is registered as a Multiple Site quality management system in conformance with

ISO 9001:2015 and AS9100D

The audit was conducted in accordance with the requirements of AS9104/1:2012-01.
PRI CertificationSM is accredited under the ICOP Scheme.

Scope of Registration:

Overall Scope:

Design, Development and Manufacture of Microwave Frequency Components, Sub-Systems and Systems, and Contract Manufacturing Services



Edward Maschmeier
Vice President of PRI Certification

Number: 19811
Issued: 01-Oct-2025
Expires: 30-Sep-2028

Page 1 of 2

161 Thorn Hill Road • Warrendale, Pennsylvania 15086-7527, USA



United States Department of State
Bureau of Political-Military Affairs
Directorate of Defense Trade Controls
Washington, D.C. 20522-0112

SEBASTIAN PALACIO
Vice-President
Planar Monolithics Industries Inc.
7309-A Grove Road
Frederick, MD 21704

2024-07-16

**For a copy of our ITAR Registration,
please contact our Sales Department at
sales@pmi-rf.com**

Any person who engages in the United States in the business of manufacturing or exporting or temporarily importing defense articles or furnishing defense services is required to register and keep that registration current with this office pursuant to the Arms Export Control Act (AECA) and the International Traffic in Arms Regulations (ITAR). A registration is current if the registration is unexpired and has accurate and up-to-date information.

Registration is a precondition to submitting an application for an export license or other approval from the Directorate of Defense Trade Controls (DDTC) or to use ITAR exemptions but does not confer any export rights or privileges. In addition, if you also plan to engage in brokering activities pursuant to ITAR Part 129, you must register as a broker with DDTC.

As the senior officer empowered to sign the registration statement, you should ensure that your organization maintains records regarding: 1) The senior officer listed on the registration who will oversee the compliance program and be responsible for designating the direct employees who will serve as "empowered officials" for their organization; and 2) The qualified, direct employees who will serve as "empowered officials," listed by name, position, business unit, phone and fax numbers and email addresses. Please note that third parties (i.e., individuals who are not direct employees, such as consultants, subcontractors, or outside counsel, for example) cannot serve as "empowered officials."

Also, ITAR Section 122.5 requires you to maintain records concerning your registration and the manufacture, acquisition, and disposition of defense articles; the provision of defense services; and information on political contributions, fees, or commissions furnished or obtained, as required by ITAR Part 130. Records maintained shall be available at all times for inspection and copying by DTCC or Customs officials. To ensure such records are maintained in accordance with ITAR Section 122.5, the organization should provide appropriate training on AECA and ITAR requirements to all employees who will be performing recordkeeping functions and ensure they comply with the ITAR. Ramifications for the failure to comply may include shipment delay and/or shipment seizure by Customs and Border Protection, loss of export privileges, and/or criminal or civil penalties.

Further, if your organization has foreign-person employees, including officers and senior managers, your organization must first obtain a license or other approval before providing such foreign-person employees with access to any ITAR-controlled technical data. It is also prohibited to provide defense services or export defense articles to subsidiaries/affiliates located in proscribed countries under ITAR Section 126.1 (for example, the People's Republic of China, North Korea, Syria, etc.). You should caution your organization's employees not to discuss the substance of ITAR-controlled information with foreign-person employees without first obtaining a license or other approval from DDTC.

You may refer to the DDTC website for a Compliance Guide at <http://www.pmddtc.state.gov/> and then click on ITAR Compliance tab, next click on How to Comply tab. The DDTC website also includes a copy of the ITAR, explanations of export licensing procedures, how to submit a license application, country sanctions, individuals / companies debarred by the Department of State, and other export matters. The website also includes procedures for requesting a commodity jurisdiction determination (ITAR Section 120.4) should you have doubt as to whether an article, services, or data is covered by the ITAR Part 121 (the U.S. Munitions List).

You may submit your organization's registration renewal up to 60 days before the registration expiration date. At latest, your registration must be received at least 30 days prior to the expiration date to avoid a lapse in registration. You should also ensure your organization's Registration is current before applying for export licenses or other approvals. Also, if appropriate, DTCC requests you to keep your registration information current by submitting amendment requests via DECCS Registration system.

For general registration related questions, please contact the DDTC Response Team at 202-663-1282 or by email at DDTCCustomerService@state.gov. For questions related to this matter, please contact Teletha Thomas at 202-632-2153.

Sincerely,

Daniel Cook
Chief, Registration, Compliance, & Analysis
Office of Defense Trade Controls Compliance

Organizational Chart

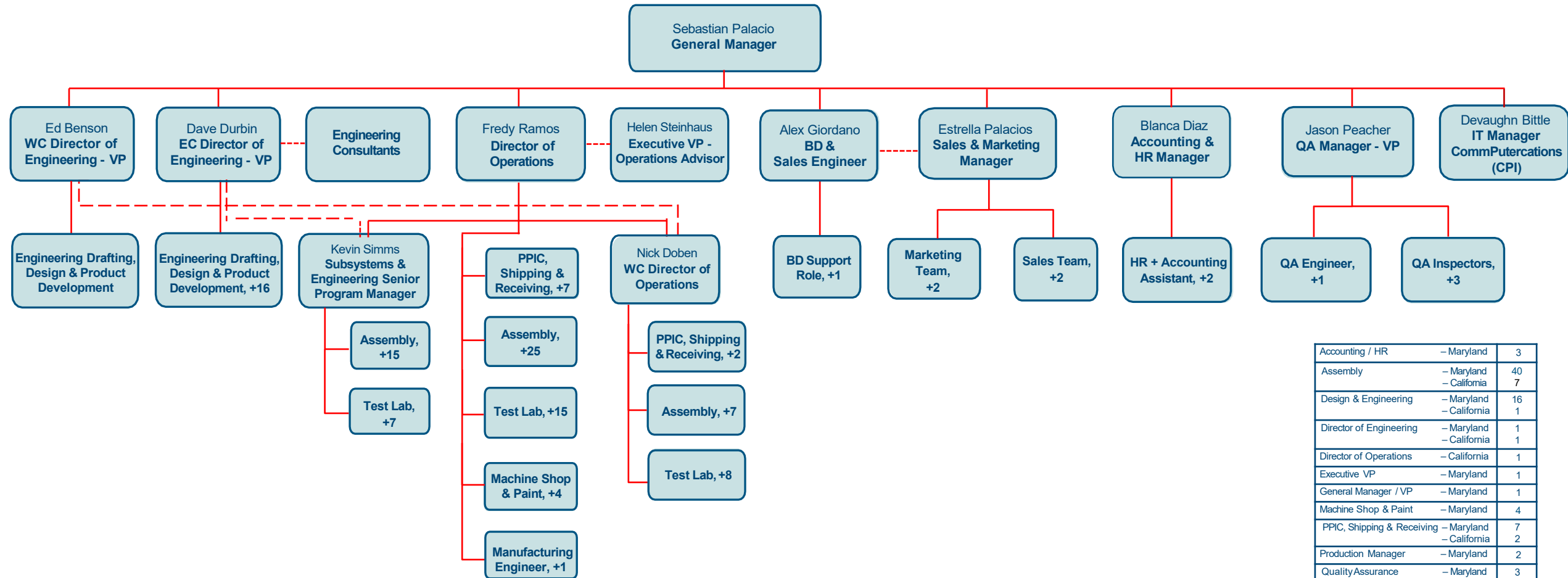

Accounting / HR	– Maryland	3
Assembly	– Maryland	40
	– California	7
Design & Engineering	– Maryland	16
	– California	1
Director of Engineering	– Maryland	1
	– California	1
Director of Operations	– California	1
Executive VP	– Maryland	1
General Manager / VP	– Maryland	1
Machine Shop & Paint	– Maryland	4
PPIC, Shipping & Receiving	– Maryland	7
	– California	2
Production Manager	– Maryland	2
Quality Assurance	– Maryland	3
	– California	1
Sales & Marketing	– Maryland	7
Test Techs	– Maryland	22
	– California	8
TOTAL		128



Thank You!

