

REVISIONS				
ZONE	REV.	DESCRIPTION	DATE	APPROVED
	-	ORIGINAL RELEASE	9/28/09	

Description:

Low Noise Amplifier designed for Military and Industrial applications. This amplifier is supplied in our standard PE2 housings in a cascade layout that can be used as a SMA connectorized or a surface mount component. Other packages and connector types are available.

This model provides the following performance. Data is available upon request.

Specifications:

Frequency Range: 3.0 to 4.0 GHz
 Gain: 60dB Typ.
 Gain Flatness: +/-0.75dB Max.
 Noise Figure: 2.0dB Typ.
 OP1dB: 13dBm Min.
 VSWR Input/Output: 2.0:1 Max.
 DC Voltage Supply: +12 to +15VDC
 DC Current Draw: 300mA Max.

Features:

Internal Voltage Regulation
 Unconditional Stability
 Standard Operating Temperature -20 to +70 Deg. C

Available Options:

Various Package types
 Various Connector types
 Temperature Compensation
 Hermetic Sealing
 Gain and Phase Matching
 MIL-STD-883 Screening Available

Environmental Ratings:

Temperature: -20 to +70 Deg. C (Operating) ; -55 to +85 Deg C Available)
 -55 to +125 Deg. C (Storage)
 Humidity: MIL-STD-202F, METHOD 103B COND B.
 Shock: MIL-STD-202F, METHOD 213B COND B.
 Altitude: MIL-STD-202F, METHOD 105C COND B.
 Temperature Cycle: MIL-STD-202F, METHOD 107D COND A

Note: The above specifications are subject to change or revision.

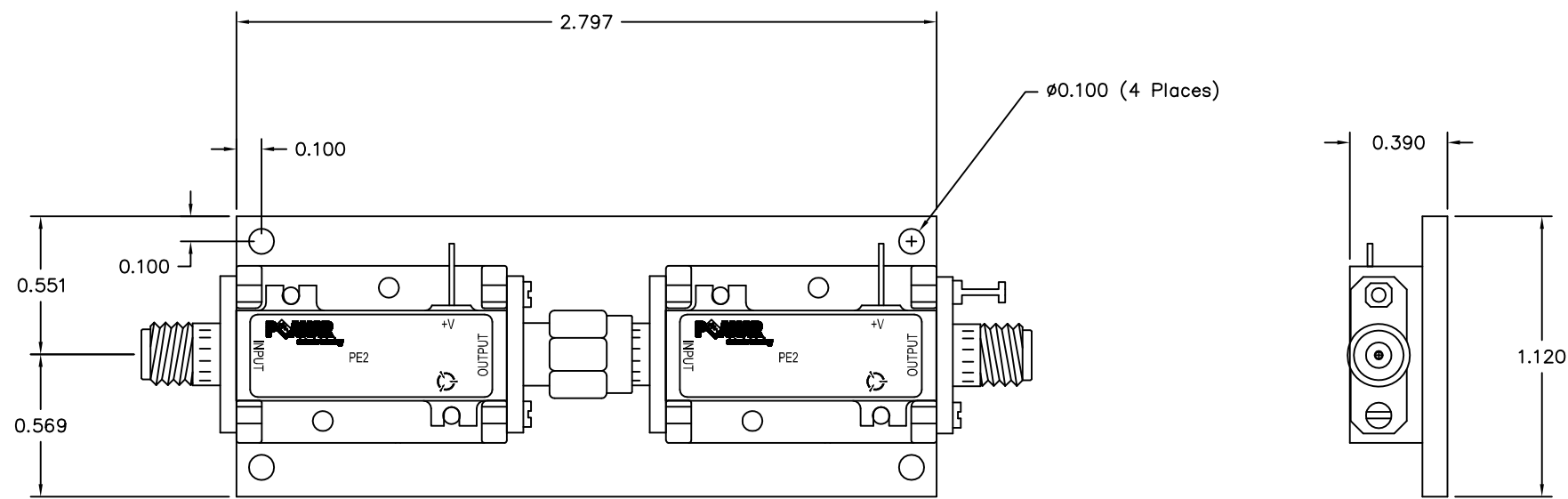

UNLESS OTHERWISE SPECIFIED
 DIMENSIONS ARE IN INCHES
 TOLERANCES ARE:
 FRACTIONS DECIMALS ANGLES
 ± .XX ± 0.010 ±
 .XXX ± 0.005

MATERIAL: 6061-T6 Aluminum	PART NO.		 5715 Industry Lane, Unit 11 FREDERICK, MARYLAND
	APPROVALS K Mason	DATE 9/28/09	
FINISH: Gold Plate over Nickel	CHECKED	ISSUED	PE2-60-3R04R0-2R0-15-12-SFF-WEB SIZE B CAGE CODE 1LK53 DWG NO. WEB - MODEL REV. A SCALE N/A SHEET 1 OF 1
DO NOT SCALE DRAWING			