

PT7-P-PW-0398

TECHNICAL REPORT

ON

2.0 TO 4.0 GHz

AND

6.0 TO 18.0 GHz

(OTHER FREQUENCIES FROM 500 MHz TO 18.0 GHz AVAILABLE, IN OCTAVE BANDS)

MINIATURE

SINGLE BALANCED

(DOUBLE BALANCED ALSO AVAILABLE)

+ 90°/-90° OR + 0°/-180°

BI-PHASE MODULATOR/SHIFTER

WITH TTL CONTROL LOGIC

(ECL CONTROL LOGIC ALSO AVAILABLE)

PMI MODEL NO:

PS-90-2040

(2.0 TO 4.0 GHz)

SERIAL NO: PM70512

AND

PS-90-8018

(6.0 TO 18.0 GHz)

SERIAL NO: MC30984 & MC30986

DESIGNED

BY

A. K. GORWARA

TESTED

BY

R. GRAY & R. AFABLE

REPORTED

BY

P. WOOD

MARCH 13, 1998

PLANAR MONOLITHICS INDUSTRIES, INC.

CORPORATE & ENGINEERING OFFICES: 1112 PERKIOMENVILLE ROAD, PERKIOMENVILLE, PA 19074

SALES & MANUFACTURING OFFICE: 7311-G GROVE ROAD, FREDERICK, MD 21704

TEL No: 301-662-4700 * FAX No: 301-662-4838 * E-MAIL: AMCPMI@AOL.COM



SPECIFICATIONS

| | | |
|----------------------------|---|---|
| • DIFFERENTIAL PHASE SHIFT | : | $\pm 90^\circ$ OR $180^\circ \pm 10^\circ$ |
| • FREQUENCY | : | 500 MHz TO 1.00 GHz (MODEL # PS-90-0510) 1.00 TO 2.00 GHz (MODEL # PS-90-1020) 2.00 TO 4.00 GHz (MODEL # PS-90-2040) 1.50 TO 4.50 GHz (MODEL # PS-90-2040E) 2.50 TO 5.00 GHz (MODEL # PS-90-2550) 1.90 TO 5.60 GHz (MODEL # PS-90-2550E) 4.00 TO 8.00 GHz (MODEL # PS-90-4080) 3.00 TO 3.00 GHz (MODEL # PS-90-4080E) 5.00 TO 10.00 GHz (MODEL # PS-90-5010) 3.75 TO 11.75 GHz (MODEL # PS-90-5010E) 6.00 TO 12.00 GHz (MODEL # PS-90-6012) 4.50 TO 13.50 GHz (MODEL # PS-90-6012E) 8.00 TO 18.00 GHz (MODEL # PS-90-8018) 6.00 TO 18.00 GHz (MODEL # PS-90-8018E) |
| • INSERTION LOSS | : | 2.5 dB TYPICAL, 3.0 dB MAX. 4.0 dB TYPICAL (6.0 TO 18.0 GHz) |
| • RETURN LOSS (VSWR) | : | 2.0:1 2.5:1 (6.0 TO 18.0 GHz) |
| • SWITCHING SPEED | : | RISE : 10nS TYPICAL, 15nS MAX. FALL : 10nS TYPICAL, 15nS MAX. DELAY ON : 50nS TYPICAL, 75nS MAX. DELAY OFF : 55nS TYPICAL, 75nS MAX. (25 nS HIGH SPEED UNITS ARE AVAILABLE) |
| • HF INPUT POWER | : | + 20 dBm OPERATING, 0.5 WATT CW, 1 μ S PULSE WIDTHS SURVIVAL |
| • CARRIER SUPPRESSION | : | 15 dB, 20 dB TYPICAL |
| • CONTROL | : | TLL (ECL IS AVAILABLE) |
| • POWER SUPPLY | : | + 5 vdc @ 75 mA MAX. (OTHER VOLTAGES AVAILABLE) - 5 vdc @ 20 mA MAX. |
| • SIZE | : | 1.0" X 1.0" X 0.50" (SLIM-LINE VERSIONS AVAILABLE) |
| • WEIGHT | : | ≤ 2.0 OZ. |

OPTIONS

| | | |
|------|---|--|
| • HS | : | HIGH SPEED AND HIGH MODULATION RATES |
| • 01 | : | SMC MALE CONTROL CONNECTOR |
| • 02 | : | SMB MALE CONTROL CONNECTOR |
| • 03 | : | SMA FEMALE CONTROL CONNECTOR |
| • 04 | : | TWO SMA MALE RF CONNECTORS |
| • 05 | : | ONE SMA MALE AND ONE SMA FEMALE RF CONNECTOR |
| • 06 | : | + 12 VDC POWER SUPPLY |
| • 07 | : | - 12 VDC POWER SUPPLY |
| • 08 | : | + 15 VDC POWER SUPPLY |
| • 09 | : | - 15 VDC POWER SUPPLY |

PLANAR MONOLITHICS INDUSTRIES, INC.



MECHANICAL OUTLINE

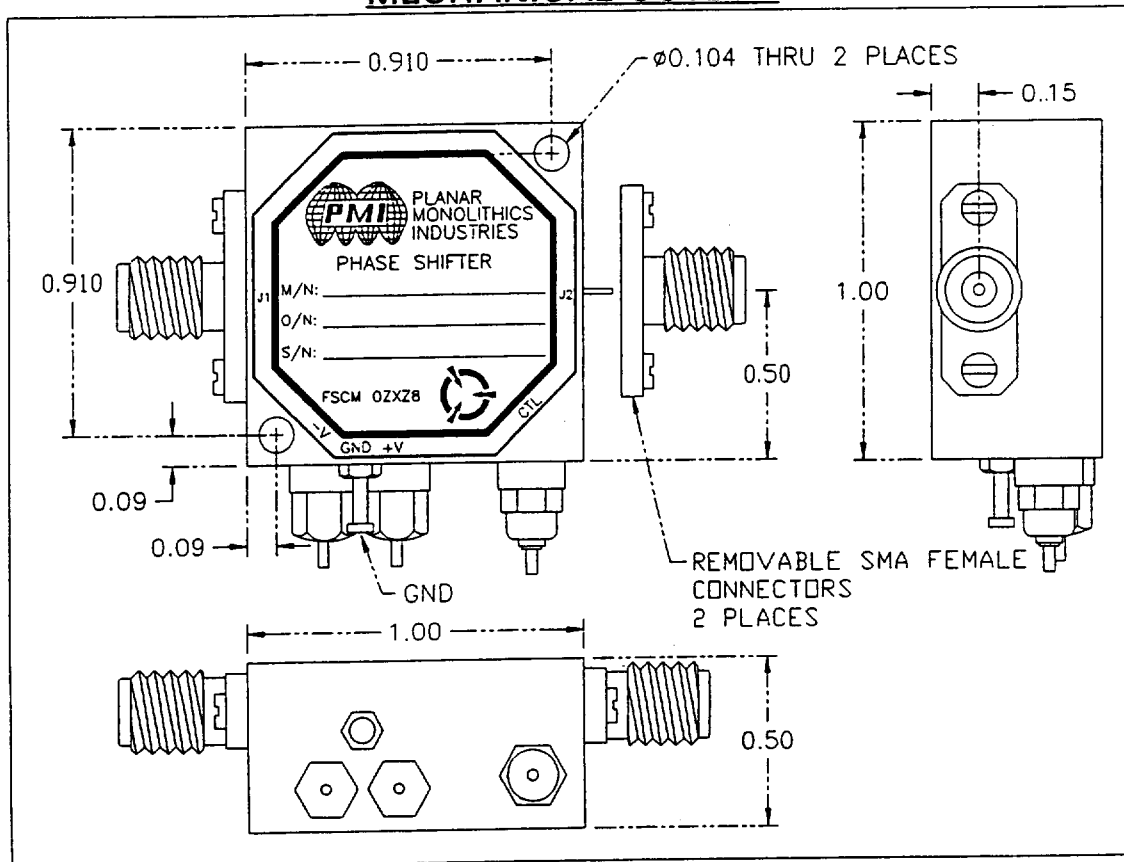

PMI BI-PHASE MODULATOR/SHIFTER, P-90 SERIES
 (SLIM-LINE VERSIONS ALSO AVAILABLE)

ENVIRONMENTAL RATING

- TEMPERATURE : -54°C TO +85° C (OPERATING)
- : -65°C TO +100°C (STORAGE)
- HUMIDITY : MIL-STD-202F, METHOD 103B COND. B
(96 hrs. @ 95%)
- SHOCK : MIL-STD-202F, METHOD 213B COND. B
(75 G, 6 mS)
- VIBRATION : MIL-STD-202F, METHOD 204D COND. B
(0.06 Inch Double Amplitude or 15 G, whichever is less)
- ALTITUDE : MIL-STD-202F, METHOD 105C COND. B
(50,000 Feet)
- TEMPERATURE CYCLE : MIL-STD-202F, METHOD 107D COND. A
(5 Cycles)

PLANAR MONOLITHICS INDUSTRIES, INC.

CORPORATE & ENGINEERING OFFICES: 1112 PERKIOMENVILLE ROAD, PERKIOMENVILLE, PA 18074
 SALES & MANUFACTURING OFFICE: 7311-G GROVE ROAD, FREDERICK, MD 21704
 TEL No: 301-662-4700 * FAX No: 301-662-4938 * E-MAIL: AMCPMI@AOL.COM



TEST DATA

ON

2.0 TO 4.0 GHz

MINIATURE

SINGLE BALANCED

(DOUBLE BALANCED ALSO AVAILABLE)

$+90^\circ/-90^\circ$ OR $+0^\circ/-180^\circ$

BI-PHASE MODULATOR/SHIFTER
WITH TTL CONTROL LOGIC

(ECL CONTROL LOGIC ALSO AVAILABLE)

PMI MODEL NO:

PS-90-2040

SERIAL NO: PM70512

DESIGNED

BY

A. K. GORWARA

TESTED

BY

R. GRAY

REPORTED

BY

P. WOOD

MARCH 13, 1998

PLANAR MONOLITHICS INDUSTRIES, INC.

CORPORATE & ENGINEERING OFFICES: 1112 PERKIOMENVILLE ROAD, PERKIOMENVILLE, PA 18074
SALES & MANUFACTURING OFFICE: 7311-G GROVE ROAD, FREDERICK, MD 21704
TEL No: 301-662-4700 * FAX No: 301-662-4938 * E-MAIL: AMCPMI@AOL.COM

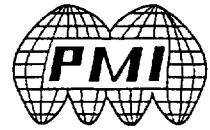

INSERTION LOSS AND RETURN LOSS

J1-J2 LOGIC "0"

AS MEASURED OVER 2.0 TO 4.0 GHz

7/29/97 BG

J1-J2 LOGIC "0"
 INSERTION / VSWR

PS-90-2040
 PMI SAMPLE
 S/N PM70512

CH1: A - 65 dB CH2: B - 17.90 dB
 1.0dB/ REF - 3.00 dB 5.0dB/ REF - 9.54 dB

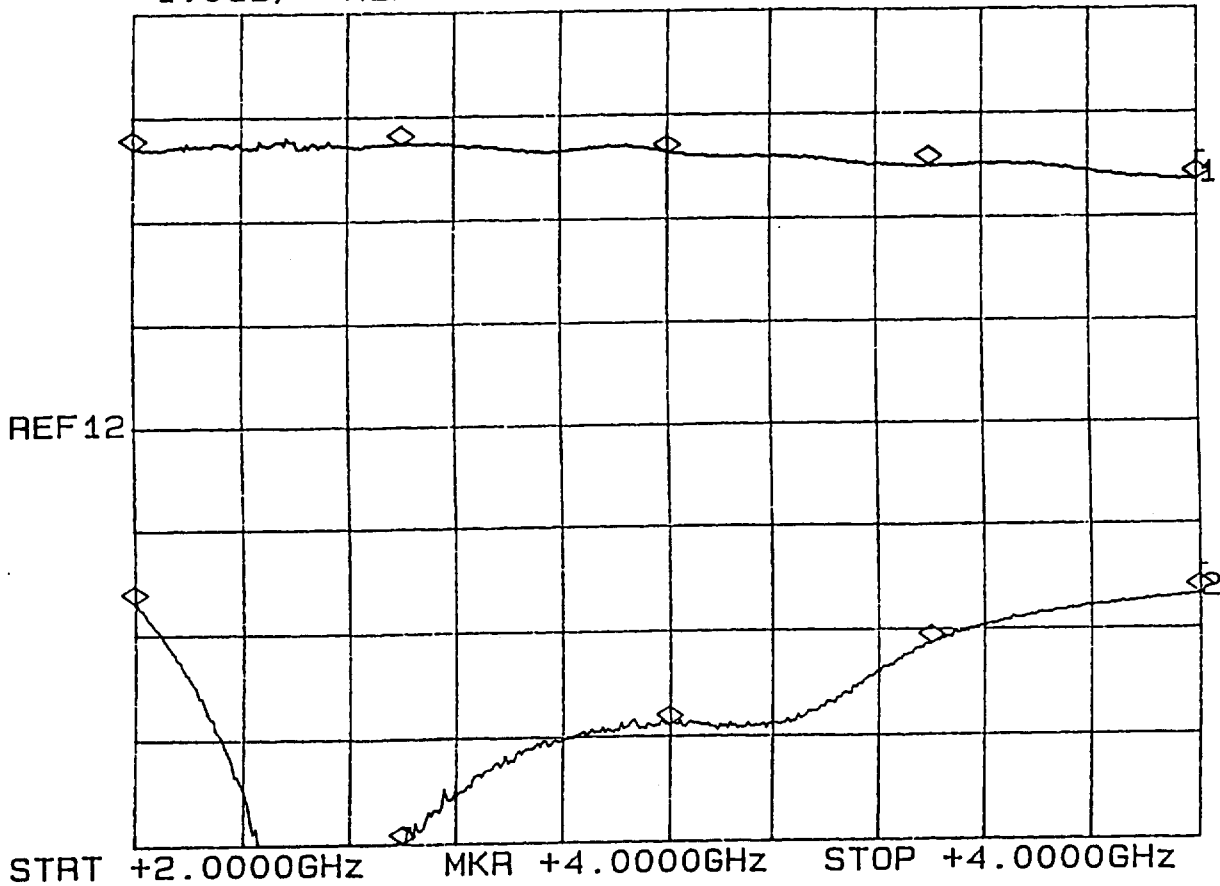

MARKERS

| | IL |
|----|-----------------|
| #1 | 2 GHz 0.28 dB |
| #2 | 2.5 GHz 0.25 dB |
| #3 | 3 GHz 0.34 dB |
| #4 | 3.5 GHz 0.49 dB |
| #5 | 4 GHz 0.63 dB |

CURRENT DRAW

| |
|-----------------|
| + 15 V @ 0.5 mA |
| - 15 V @ 0.5 mA |

VSWR

| | dB | VSWR |
|----|---------------|---------|
| #1 | 2 GHz -17.9 | -1.29:1 |
| #2 | 2.5 GHz -29.4 | -1.07:1 |
| #3 | 3 GHz -23.9 | -1.14:1 |
| #4 | 3.5 GHz -20.2 | -1.22:1 |
| #5 | 4 GHz -17.9 | -1.29:1 |

PLANAR MONOLITHICS INDUSTRIES, INC.

CORPORATE & ENGINEERING OFFICES: 1112 PERKIOMENVILLE ROAD, PERKIOMENVILLE, PA 18074
 SALES & MANUFACTURING OFFICE: 7311-G GROVE ROAD, FREDERICK, MD 21704
 TEL No: 301-662-4700 • FAX No: 301-662-4938 • E-MAIL: AMCPMI@AOL.COM

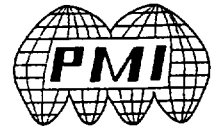

INSERTION LOSS AND RETURN LOSS

J1-J2 LOGIC "1"

AS MEASURED OVER 2.0 TO 4.0 GHz

7/29/97 BG

J1-J2 LOGIC "1"
 INSERTION / VSWR

PS-90-2040
 PMI SAMPLE
 S/N PM70512

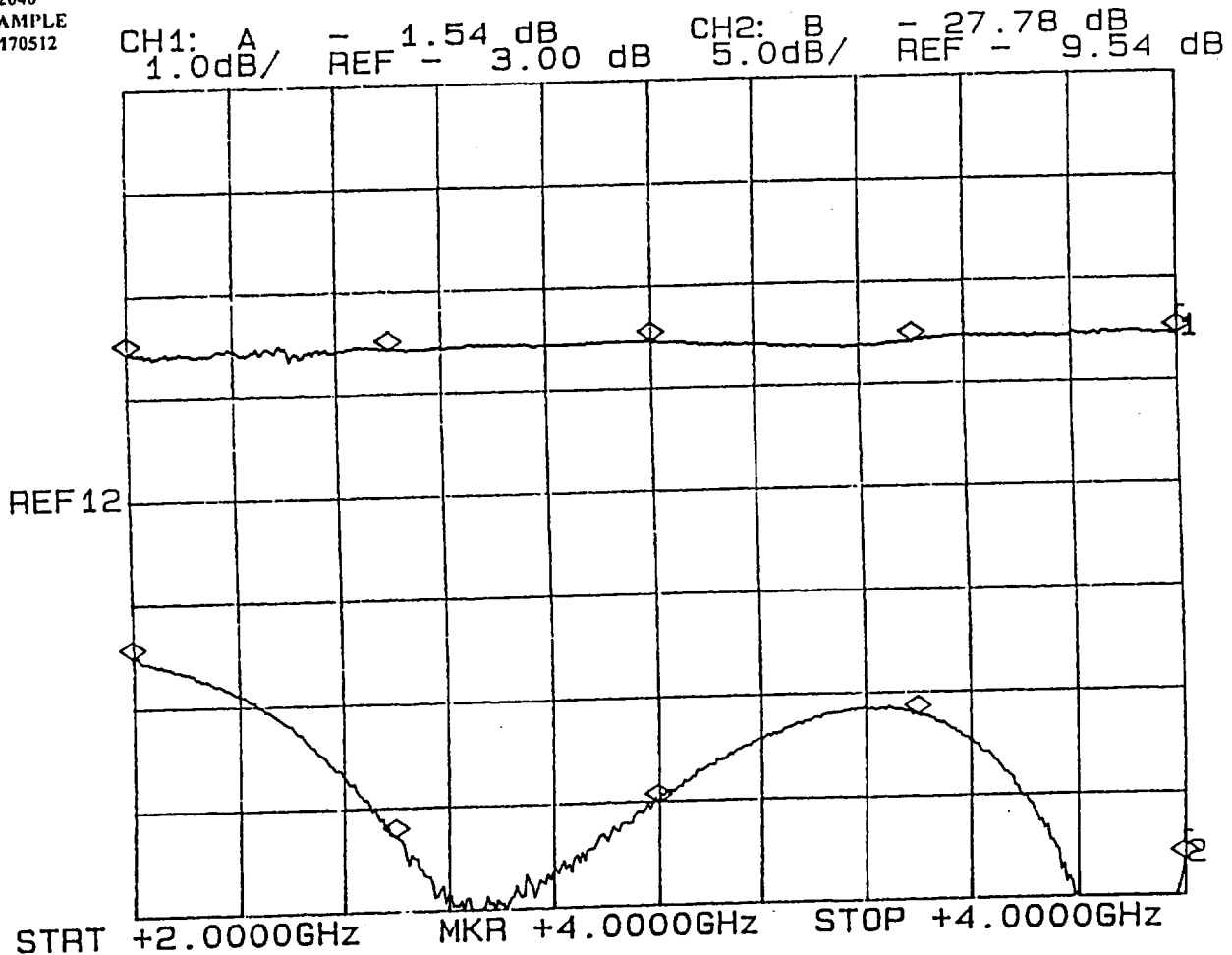

| MARKERS | | |
|---------|---------|---------|
| | IL | |
| #1 | 2 GHz | 1.57 dB |
| #2 | 2.5 GHz | 1.59 dB |
| #3 | 3 GHz | 1.57 dB |
| #4 | 3.5 GHz | 1.60 dB |
| #5 | 4 GHz | 1.57 dB |

| CURRENT DRAW | |
|--------------|----------|
| + 15 V | @ 67 mA |
| - 15 V | @ 1.5 mA |

| VSWR | | |
|------|---------|---------------|
| | dB | VSWR |
| #1 | 2 GHz | -17.2 -1.32:1 |
| #2 | 2.5 GHz | -26.1 -1.10:1 |
| #3 | 3 GHz | -24.2 -1.13:1 |
| #4 | 3.5 GHz | -20.5 -1.21:1 |
| #5 | 4 GHz | -28.0 -1.08:1 |

PLANAR MONOLITHICS INDUSTRIES, INC.

CORPORATE & ENGINEERING OFFICES: 1112 PERKIOMENVILLE ROAD, PERKIOMENVILLE, PA 18074
 SALES & MANUFACTURING OFFICE: 7311-G GROVE ROAD, FREDERICK, MD 21704
 TEL No: 301-662-4700 • FAX No: 301-662-4938 • E-MAIL: AMCPMI@AOL.COM

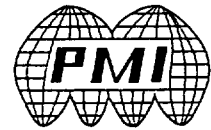

INSERTION LOSS AND RETURN LOSS

J2-J1 LOGIC "0"

AS MEASURED OVER 2.0 TO 4.0 GHz

7/29/97 BG

J2-J1 LOGIC "0"
 INSERTION / VSWR

PS-90-2040
 PMI SAMPLE
 S/N PM70512

CH1: A - .71 dB CH2: B - 14.64 dB
 1.0dB/ REF - 3.00 dB 5.0dB/ REF - 9.54 dB



MARKERS

| | IL |
|----|-----------------|
| #1 | 2 GHz 0.32 dB |
| #2 | 2.5 GHz 0.25 dB |
| #3 | 3 GHz 0.33 dB |
| #4 | 3.5 GHz 0.48 dB |
| #5 | 4 GHz 0.67 dB |

CURRENT DRAW

+15 V @ 0.5 mA
 -15 V @ 0.5 mA

VSWR

| | dB | VSWR |
|----|---------------|---------|
| #1 | 2 GHz -17.3 | -1.32:1 |
| #2 | 2.5 GHz -29.2 | -1.07:1 |
| #3 | 3 GHz -34.0 | -1.04:1 |
| #4 | 3.5 GHz -18.3 | -1.28:1 |
| #5 | 4 GHz -14.6 | -1.46:1 |

PLANAR MONOLITHICS INDUSTRIES, INC.

CORPORATE & ENGINEERING OFFICES: 1112 PERKIOMENVILLE ROAD, PERKIOMENVILLE, PA 18074

SALES & MANUFACTURING OFFICE: 7311-G GROVE ROAD, FREDERICK, MD 21704

TEL No: 301-662-4700 • FAX No: 301-662-4938 • E-MAIL: AMCPMI@AOL.COM



INSERTION LOSS AND RETURN LOSS

J2-J1 LOGIC "1"

AS MEASURED OVER 2.0 TO 4.0 GHz

7/29/97 BG

J2-J1 LOGIC "1"
 INSERTION / VSWR

PS-90-2040
 PMI SAMPLE
 S/N PN170512

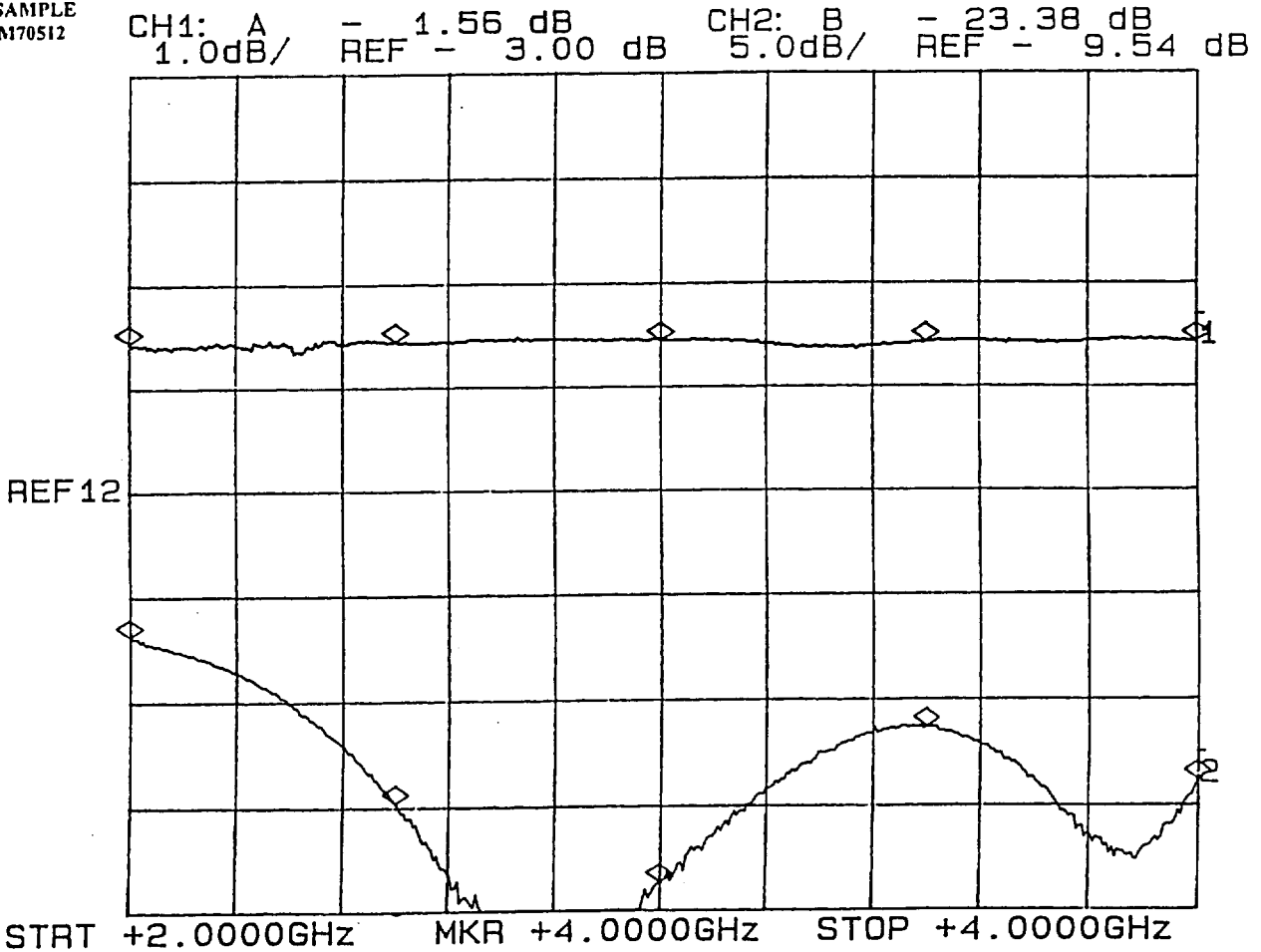

| MARKERS | | |
|---------|---------|---------|
| | IL | |
| #1 | 2 GHz | 1.54 dB |
| #2 | 2.5 GHz | 1.56 dB |
| #3 | 3 GHz | 1.54 dB |
| #4 | 3.5 GHz | 1.56 dB |
| #5 | 4 GHz | 1.56 dB |

| CURRENT DRAW | |
|--------------|--------|
| + 15 V @ | 67 mA |
| - 15 V @ | 1.5 mA |

| VSWR | | |
|------|---------|---------------|
| | dB | VSWR |
| #1 | 2 GHz | -16.4 -1.36:1 |
| #2 | 2.5 GHz | -24.6 -1.13:1 |
| #3 | 3 GHz | -28.3 -1.08:1 |
| #4 | 3.5 GHz | -20.7 -1.20:1 |
| #5 | 4 GHz | -23.6 -1.14:1 |

PLANAR MONOLITHICS INDUSTRIES, INC.

CORPORATE & ENGINEERING OFFICES: 1112 PERKIOMENVILLE ROAD, PERKIOMENVILLE, PA 18074
 SALES & MANUFACTURING OFFICE: 7311-G GROVE ROAD, FREDERICK, MD 21704
 TEL No: 301-662-4700 * FAX No: 301-662-4938 * E-MAIL: AMCPMI@AOL.COM



INSERTION LOSS AND RETURN LOSS

J1-J2 LOGIC "0"

AS MEASURED OVER 1.0 TO 5.0 GHz

7/29/97 BG

J1-J2 LOGIC "0"
 INSERTION / VSWR

PS-90-2040
 PMI SAMPLE
 S/N PM70512

CH1: A - 2.42 dB CH2: B - 6.11 dB
 1.0dB/ REF - 3.00 dB 5.0dB/ REF - 9.54 dB

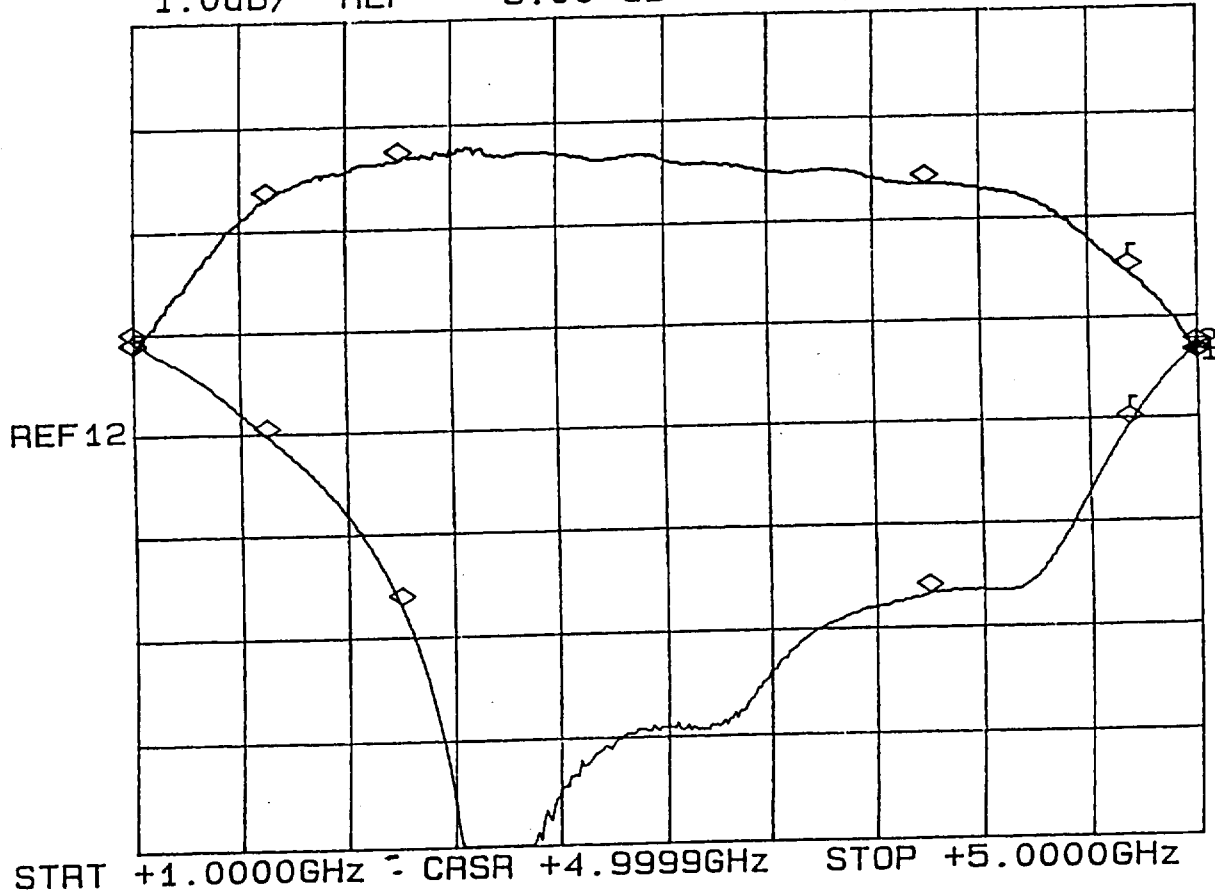

| MARKERS | | |
|---------|----------|---------|
| IL | | |
| #1 | 1 GHz | 2.16 dB |
| #2 | 1.5 GHz | 0.68 dB |
| #3 | 2 GHz | 0.33 dB |
| #4 | 4 GHz | 0.64 dB |
| #5 | 4.75 GHz | 1.53 dB |
| #6 | 5 GHz | 2.39 dB |

| CURRENT DRAW | |
|--------------|--------|
| + 15 V @ | 0.5 mA |
| - 15 V @ | 0.5 mA |

| VSWR | | |
|---------|----------|---------------|
| dB VSWR | | |
| #1 | 1 GHz | -4.94 -3.61:1 |
| #2 | 1.5 GHz | -9.67 -1.98:1 |
| #3 | 2 GHz | -17.9 -1.29:1 |
| #4 | 4 GHz | -17.9 -1.29:1 |
| #5 | 4.75 GHz | -9.85 -1.95:1 |
| #6 | 5 GHz | -6.10 -2.96:1 |

PLANAR MONOLITHICS INDUSTRIES, INC.

CORPORATE & ENGINEERING OFFICES: 1112 PERKIOMENVILLE ROAD, PERKIOMENVILLE, PA 18074
 SALES & MANUFACTURING OFFICE: 7311-G GROVE ROAD, FREDERICK, MD 21704
 TEL No: 301-662-4700 * FAX No: 301-662-4938 * E-MAIL: AMCPMI@AOL.COM

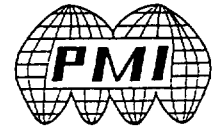

INSERTION LOSS AND RETURN LOSS

J1-J2 LOGIC "1"

AS MEASURED OVER 1.0 TO 5.0 GHz

7/29/97 BG

J1-J2 LOGIC "1"
 INSERTION / VSWR

PS-90-2040
 PMI SAMPLE
 S/N PM170512

CH1: A - 2.95 dB REF - 3.00 dB CH2: B - 6.95 dB REF - 9.54 dB
 1.0dB/ 5.0dB/

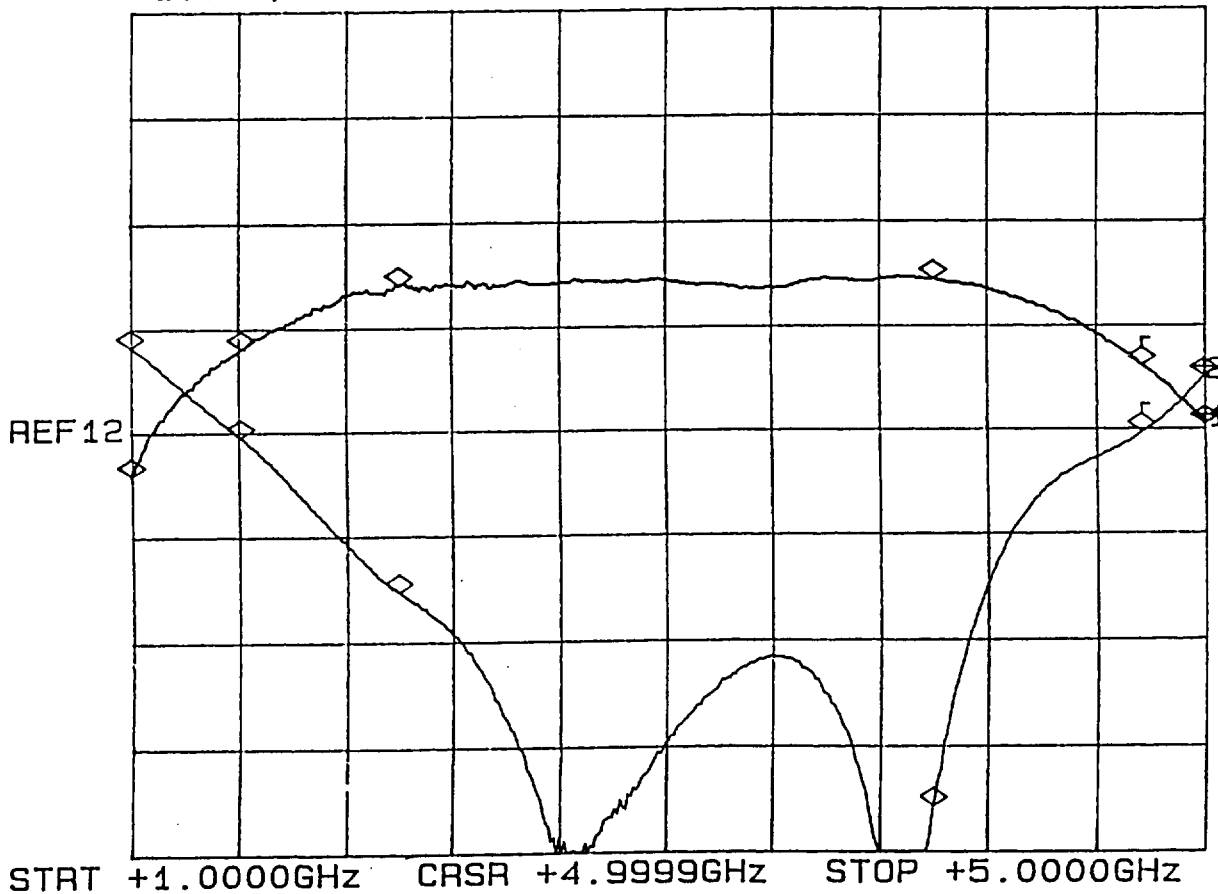

| | | <u>VSWR</u> | |
|----|----------|-------------|---------|
| | | dB | VSWR |
| #1 | 1 GHz | -5.45 | -3.29:1 |
| #2 | 1.41 GHz | -9.78 | -1.96:1 |
| #3 | 2 GHz | -17.2 | -1.32:1 |
| #4 | 4 GHz | -27.6 | -1.09:1 |
| #5 | 4.77 GHz | -9.70 | -1.97:1 |
| #6 | 5 GHz | -6.94 | -2.63:1 |

| <u>CURRENT DRAW</u> | |
|---------------------|--------|
| +15 V @ | 67 mA |
| -15 V @ | 1.5 mA |

| <u>MARKERS</u> | |
|----------------|------------------|
| IL | |
| #1 | 1 GHz 3.44 dB |
| #2 | 1.41 GHz 2.21 dB |
| #3 | 2 GHz 1.60 dB |
| #4 | 4 GHz 1.57 dB |
| #5 | 4.77 GHz 2.40 dB |
| #6 | 5 GHz 2.98 dB |

PLANAR MONOLITHICS INDUSTRIES, INC.

CORPORATE & ENGINEERING OFFICES: 1112 PERKIOMENVILLE ROAD, PERKIOMENVILLE, PA 18074
 SALES & MANUFACTURING OFFICE: 7311-G GROVE ROAD, FREDERICK, MD 21704
 TEL No: 301-662-4700 • FAX No: 301-662-4938 • E-MAIL: AMCPMI@AOL.COM

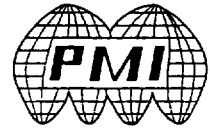

INSERTION LOSS AND RETURN LOSS

J2-J1 LOGIC "0"

AS MEASURED OVER 1.0 TO 5.0 GHz

7/29/97 BG

J2-J1 LOGIC "0"
 INSERTION / VSWR

PS-90-2040
 PMI SAMPLE
 S/N PM70512

CH1: A - 2.39 dB CH2: B - 6.00 dB
 1.0dB/ REF - 3.00 dB 5.0dB/ REF - 9.54 dB

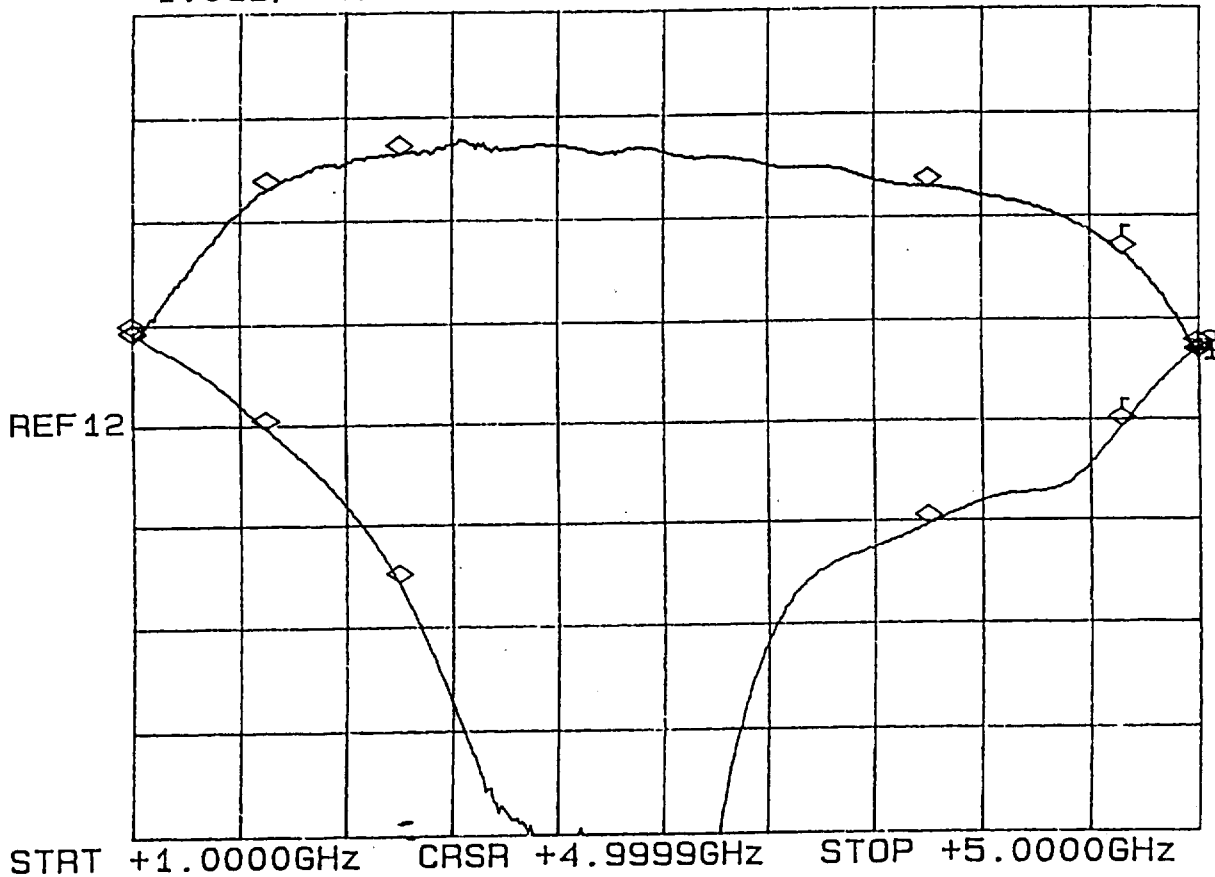

| MARKERS | |
|---------|------------------|
| IL | |
| #1 | 1 GHz 2.15 dB |
| #2 | 1.5 GHz 0.66 dB |
| #3 | 2 GHz 0.33 dB |
| #4 | 4 GHz 0.68 dB |
| #5 | 4.72 GHz 1.36 dB |
| #6 | 5 GHz 2.37 dB |

| CURRENT DRAW | |
|-----------------|--|
| + 15 V @ 0.5 mA | |
| - 15 V @ 0.5 mA | |

| VSWR | | |
|------|----------------|---------|
| | dB | VSWR |
| #1 | 1 GHz -4.92 | -3.62:1 |
| #2 | 1.5 GHz -9.78 | -1.96:1 |
| #3 | 2 GHz -17.4 | -1.31:1 |
| #4 | 4 GHz -14.7 | -1.45:1 |
| #5 | 4.72 GHz -9.73 | -1.97:1 |
| #6 | 5 GHz -5.99 | -3.01:1 |

PLANAR MONOLITHICS INDUSTRIES, INC.

CORPORATE & ENGINEERING OFFICES: 1112 PERKIOMENVILLE ROAD, PERKIOMENVILLE, PA 18074
 SALES & MANUFACTURING OFFICE: 7311-G GROVE ROAD, FREDERICK, MD 21704
 TEL No: 301-662-4700 * FAX No: 301-662-4938 * E-MAIL: AMCPMI@AOL.COM

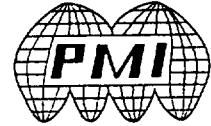

INSERTION LOSS AND RETURN LOSS

J2-J1 LOGIC "1"

AS MEASURED OVER 1.0 TO 5.0 GHz

7/29/97 BG

J2-J1 LOGIC "1"
 INSERTION / VSWR

PS-90-2040
 PMI SAMPLE
 S/N PM70512

CH1: A - 2.93 dB CH2: B - 7.39 dB
 1.0dB/ REF -- 3.00 dB 5.0dB/ REF - 9.54 dB

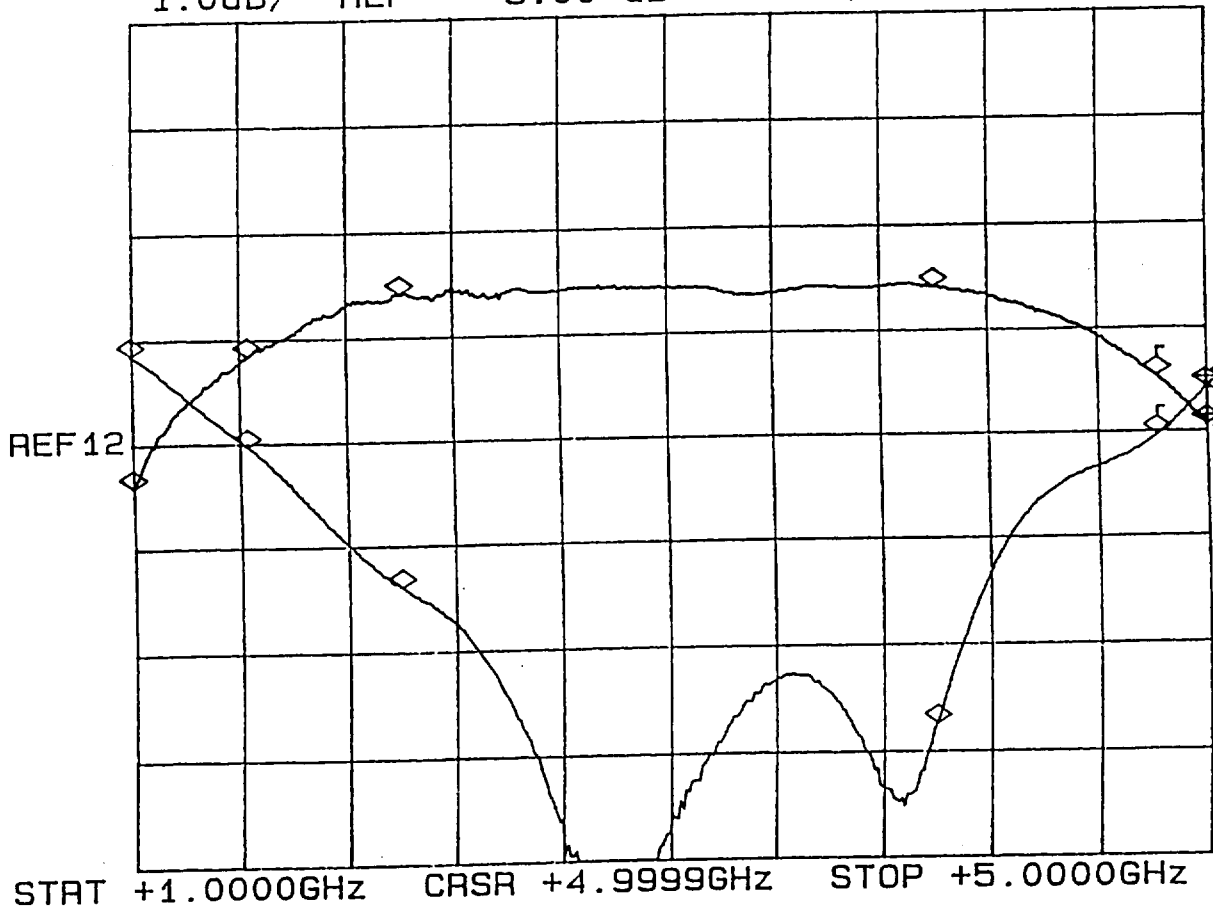

| MARKERS | |
|---------|------------------|
| IL | |
| #1 | 1 GHz 3.40 dB |
| #2 | 1.43 GHz 2.17 dB |
| #3 | 2 GHz 1.57 dB |
| #4 | 4 GHz 1.58 dB |
| #5 | 4.82 GHz 2.46 dB |
| #6 | 5 GHz 2.94 dB |

| CURRENT DRAW | |
|--------------|----------|
| +15 V | @ 67 mA |
| -15 V | @ 1.5 mA |

| VSWR | | |
|------|----------------|---------|
| | dB | VSWR |
| #1 | 1 GHz -5.20 | -3.44:1 |
| #2 | 1.43 GHz -9.67 | -1.98:1 |
| #3 | 2 GHz -16.5 | -1.35:1 |
| #4 | 4 GHz -23.3 | -1.15:1 |
| #5 | 4.82 GHz -9.64 | -1.98:1 |
| #6 | 5 GHz -7.37 | -2.50:1 |

PLANAR MONOLITHICS INDUSTRIES, INC.

CORPORATE & ENGINEERING OFFICES: 1112 PERKIOMENVILLE ROAD, PERKIOMENVILLE, PA 18074
 SALES & MANUFACTURING OFFICE: 7311-G GROVE ROAD, FREDERICK, MD 21704
 TEL No: 301-662-4700 • FAX No: 301-662-4938 • E-MAIL: AMCPMI@AOL.COM

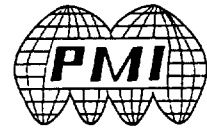

INSERTION LOSS AND RETURN LOSS
J1-J2 LOGIC "0"
 AS MEASURED OVER 0.01 TO 18.0 GHz

7/29/97 BG

J1-J2 LOGIC "0"
 INSERTION / VSWR

PS-90-2040
 PMI SAMPLE
 S/N PM70512

CH1: A - 6.91 dB REF - 3.00 dB CH2: B - 2.62 dB REF - 9.54 dB
 1.0dB/ 5.0dB/

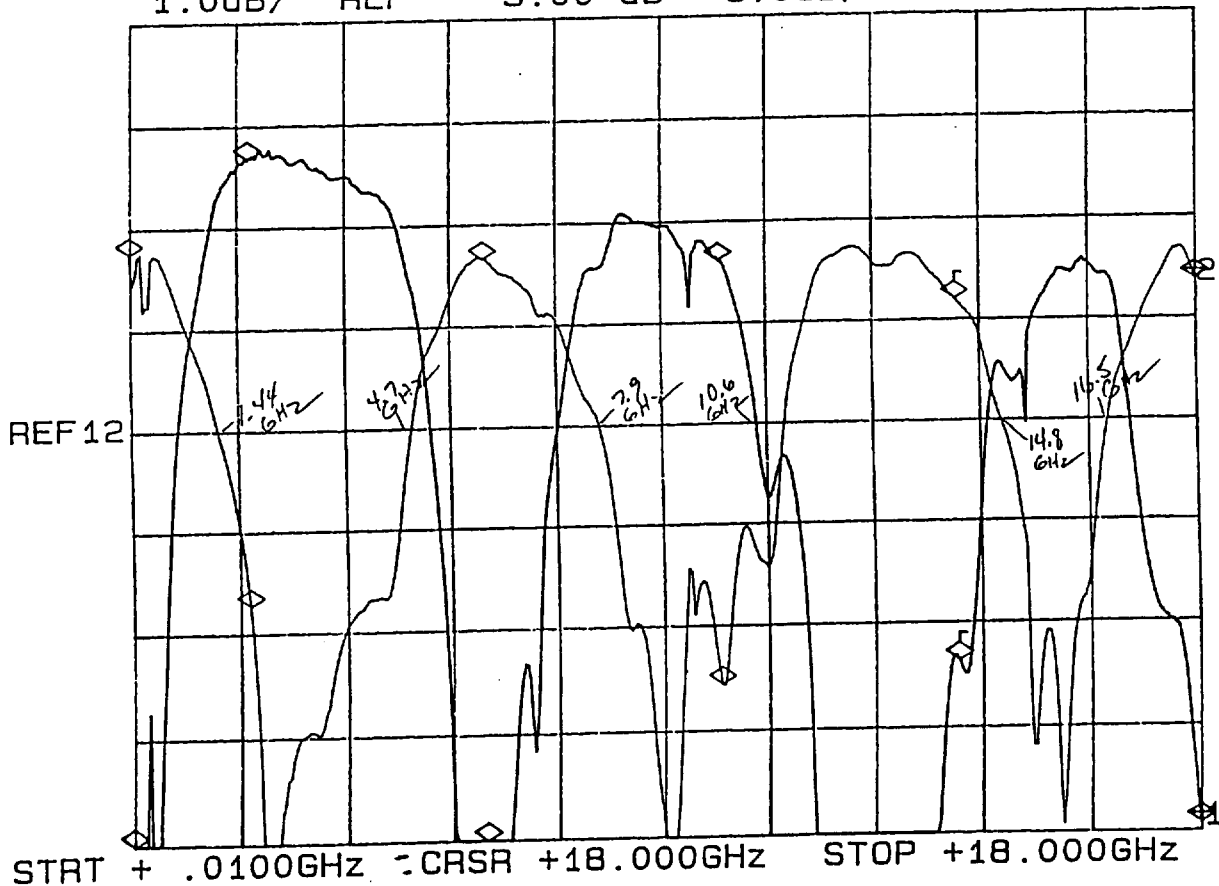

| MARKERS | | |
|---------|--------|---------|
| | IL | |
| #1 | 10 MHz | 15.6 dB |
| #2 | 2 GHz | 0.32 dB |
| #3 | 6 GHz | 16.2 dB |
| #4 | 10 GHz | 1.34 dB |
| #5 | 14 GHz | 5.32 dB |
| #6 | 18 GHz | 6.82 Db |

CURRENT DRAW
 +15 V @ 0.5 mA
 -15 V @ 0.5 mA

| VSWR | | |
|------|--------|----------------|
| | dB | VSWR |
| #1 | 10 MHz | -0.70 -24.83:1 |
| #2 | 2 GHz | -18.1 -1.28:1 |
| #3 | 6 GHz | -1.20 -14.50:1 |
| #4 | 10 GHz | -22.5 -1.16:1 |
| #5 | 14 GHz | -3.48 -5.06:1 |
| #6 | 18 GHz | -2.55 -6.86:1 |

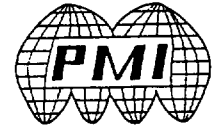

INSERTION LOSS AND RETURN LOSS
J1-J2 LOGIC "1"

AS MEASURED OVER 0.01 TO 18.0 GHz

7/29/97 BG

J1-J2 LOGIC "1"
 INSERTION / VSWR

1'S-90-2040
 PMI SAMPLE
 S/N PM170512

CH1: A - 26.16 dB REF - 3.00 dB
 1.0dB/ CH2: B - 1.21 dB REF - 9.54 dB
 5.0dB/

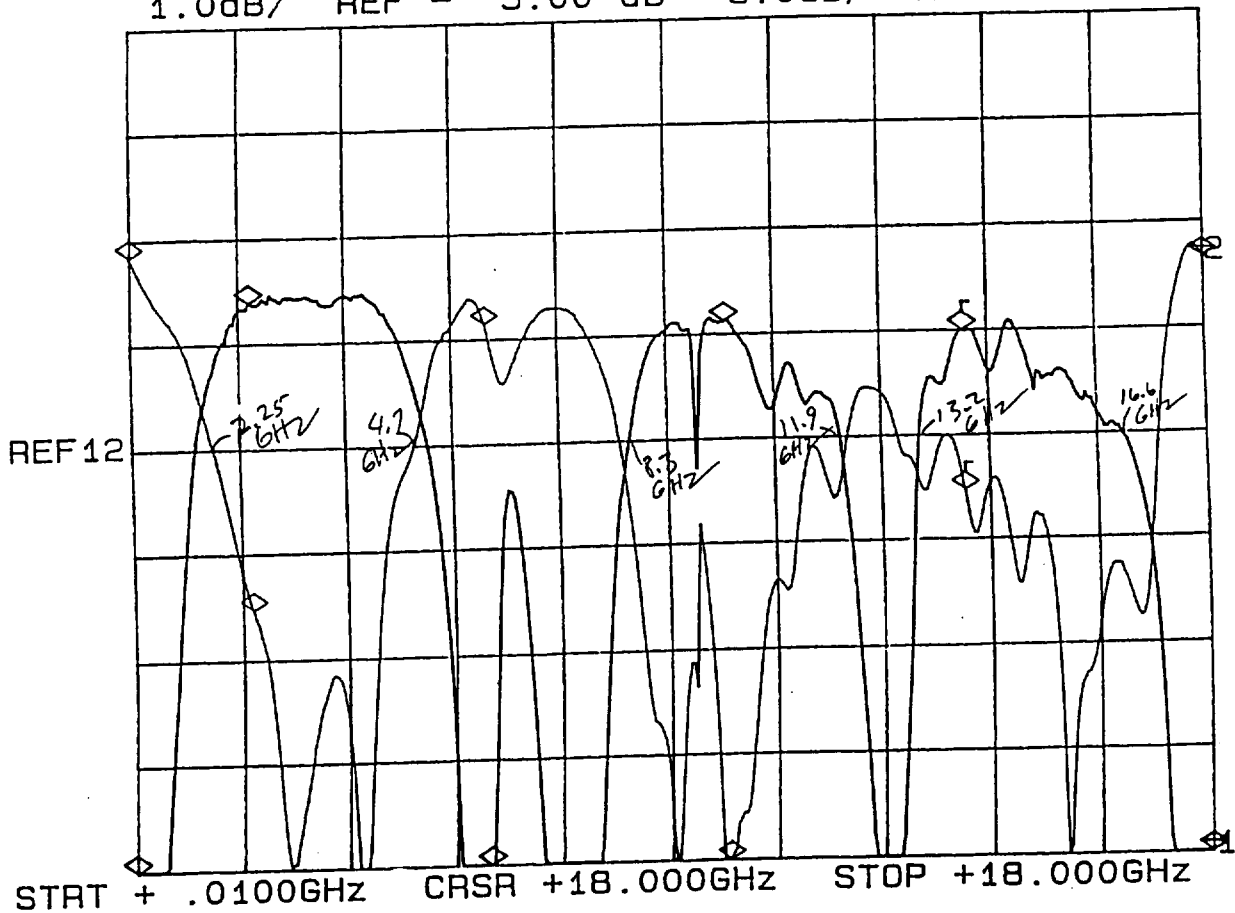

| MARKERS | |
|---------|----------------|
| IL | |
| #1 | 10 MHz 28.2 dB |
| #2 | 2 GHz 1.58 dB |
| #3 | 6 GHz 9.21 dB |
| #4 | 10 GHz 1.88 dB |
| #5 | 14 GHz 1.96 dB |
| #6 | 18 GHz 26.0 dB |

| CURRENT DRAW | |
|--------------|----------|
| +15 V | @ 67 mA |
| -15 V | @ 1.5 mA |

| VSWR | | |
|------|--------|----------------|
| | dB | VSWR |
| #1 | 10 MHz | -0.34 -51.10:1 |
| #2 | 2 GHz | -17.2 -1.32:1 |
| #3 | 6 GHz | -3.83 -4.61:1 |
| #4 | 10 GHz | -30.4 -1.06:1 |
| #5 | 14 GHz | -12.2 -1.65:1 |
| #6 | 18 GHz | -1.23 -14.15:1 |

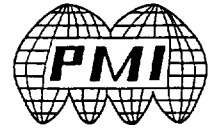

INSERTION LOSS AND RETURN LOSS

J2-J1 LOGIC "0"

AS MEASURED OVER 0.01 TO 18.0 GHz

7/29/97 BG

J2-J1 LOGIC "0"
 INSERTION / VSWR

PS-90-2040
 PMI SAMPLE
 S/N PM170512

CH1: A - 7.17 dB CH2: B - 3.55 dB
 1.0dB/ REF - 3.00 dB 5.0dB/ REF - 9.54 dB

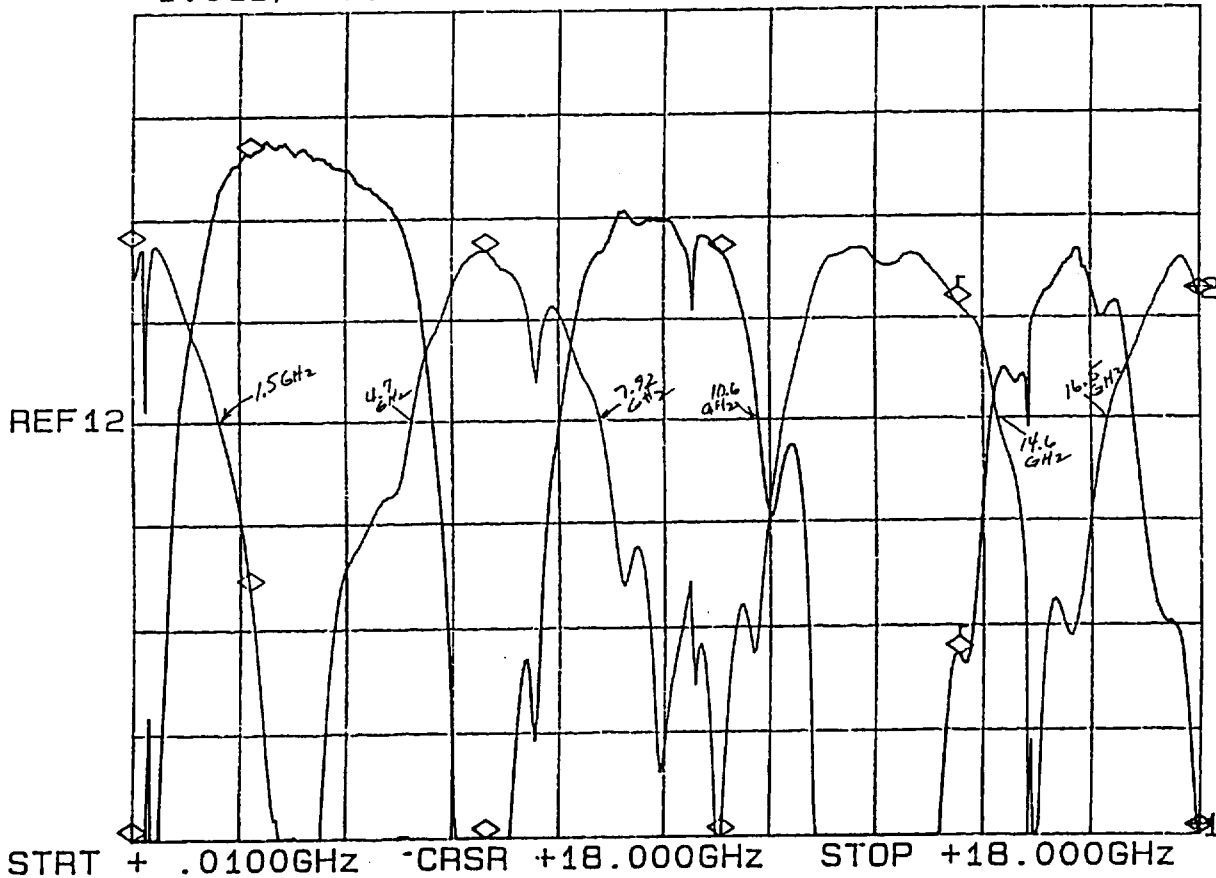

MARKERS

| # | Freq | IL |
|----|--------|---------|
| #1 | 10 MHz | 15.6 dB |
| #2 | 2 GHz | 0.36 dB |
| #3 | 6 GHz | 19.2 dB |
| #4 | 10 GHz | 1.32 dB |
| #5 | 14 GHz | 5.26 dB |
| #6 | 18 GHz | 7.17 Db |

CURRENT DRAW

+ 15 V @ 0.5 mA
 - 15 V @ 0.5 mA

VSWR

| # | Freq | dB | VSWR |
|----|--------|-------|----------|
| #1 | 10 MHz | -0.76 | -22.87:1 |
| #2 | 2 GHz | -17.6 | -1.30:1 |
| #3 | 6 GHz | -1.14 | -15.26:1 |
| #4 | 10 GHz | -29.9 | -1.07:1 |
| #5 | 14 GHz | -3.88 | -4.55:1 |
| #6 | 18 GHz | -3.59 | -4.91:1 |

PLANAR MONOLITHICS INDUSTRIES, INC.

CORPORATE & ENGINEERING OFFICES: 1112 PERKIOMENVILLE ROAD, PERKIOMENVILLE, PA 18074
 SALES & MANUFACTURING OFFICE: 7311-G GROVE ROAD, FREDERICK, MD 21704
 TEL No: 301-662-4700 • FAX No: 301-662-4938 • E-MAIL: AMCPMI@AOL.COM

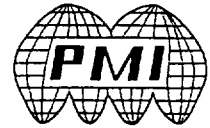

INSERTION LOSS AND RETURN LOSS
J2-J1 LOGIC "1"
 AS MEASURED OVER 0.01 TO 18.0 GHz

7/29/97 BG

J2-J1 LOGIC "1"
 INSERTION / VSWR

PS-90-2040
 PMI SAMPLE
 S/N PA170512

CH1: A - 26.40 dB REF - 3.00 dB
 1.0dB/
 CH2: B - 1.55 dB REF - 9.54 dB
 5.0dB/

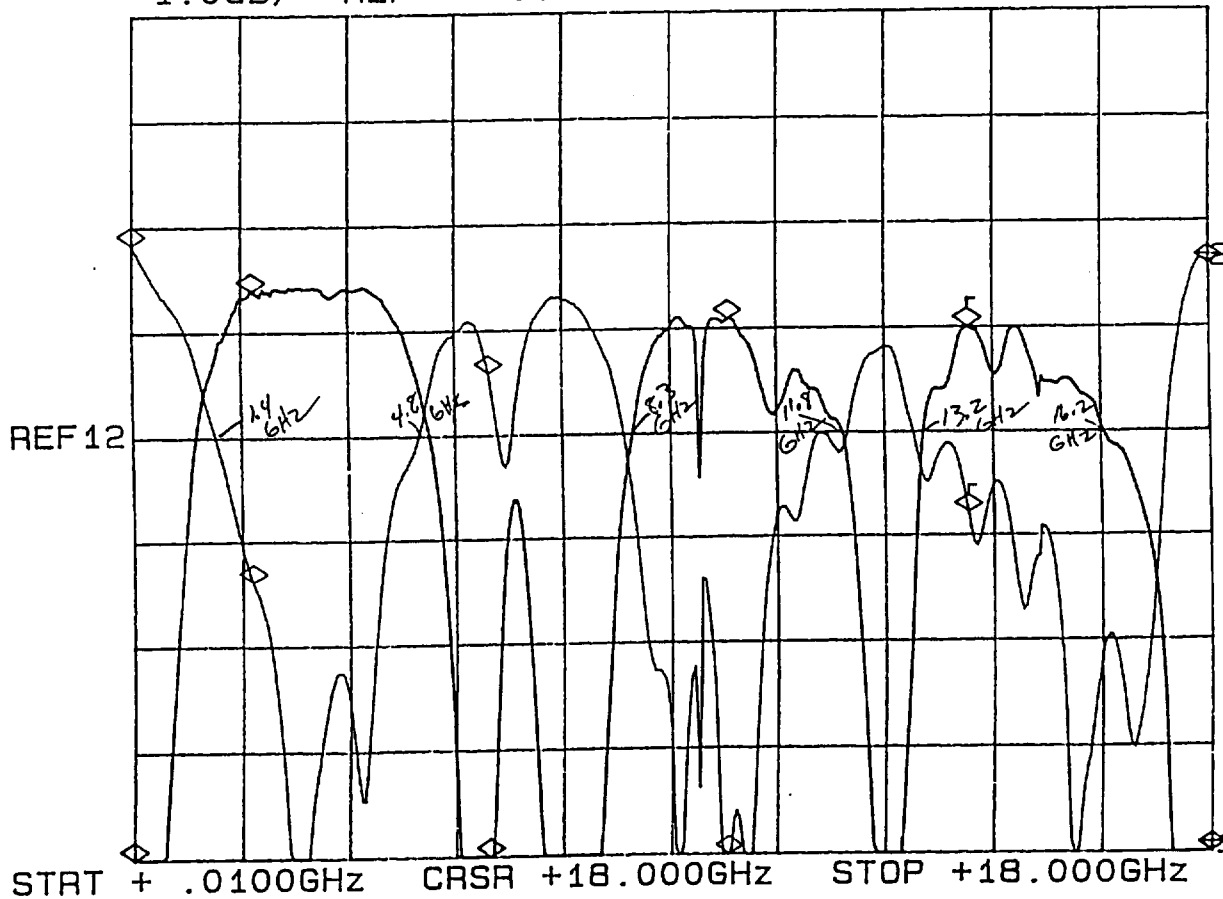

| MARKERS | | |
|---------|--------|---------|
| | IL | |
| #1 | 10 MHz | 28.2 dB |
| #2 | 2 GHz | 1.58 dB |
| #3 | 6 GHz | 9.21 dB |
| #4 | 10 GHz | 1.88 dB |
| #5 | 14 GHz | 1.96 dB |
| #6 | 18 GHz | 26.0 dB |

| CURRENT DRAW | |
|--------------|----------|
| +15 V | @ 67 mA |
| -15 V | @ 1.5 mA |

| VSWR | | |
|------|--------|----------------|
| | dB | VSWR |
| #1 | 10 MHz | -0.31 -56.04:1 |
| #2 | 2 GHz | -16.5 -1.35:1 |
| #3 | 6 GHz | -6.71 -2.72:1 |
| #4 | 10 GHz | -32.0 -1.05:1 |
| #5 | 14 GHz | -13.4 -1.54:1 |
| #6 | 18 GHz | -1.55 -11.24:1 |

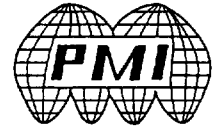

TYPICAL TEST DATA
 AS MEASURED FROM 2.0 TO 4.0 GHz

FORM: PS-1/0993



PHASE SHIFTER TEST DATA

JOBNO: 99705 MODELNO: PS-90-2040 SERIALNO: PM70512
 CUSTOMER: PMI TECHNICIAN: B Gray
 SPECIFICATION: _____ FREQUENCY RANGE: 2.0-4.0 GHz

| INSERTION LOSS | VSWR | LOGIC |
|-----------------|--------|---------------------|
| J1-J2 - 0.70 dB | -17.99 | '0' + 0.5mA - 0.5mA |
| J1-J2 - 1.69 dB | -17.20 | '1' + 65mA - 1.5mA |
| J2-J1 - 0.74 dB | -14.90 | '0' + 0.5mA - 0.5mA |
| J2-J2 - 1.67 dB | -16.45 | '1' + 65mA - 1.5mA |
| | | |
| | | |
| | | |
| | | |
| | | |

NOTE: ANY ADDITIONAL TEST DATA WRITE ON BACK PAGE.

TESTED BY: B Gray
 QA/QC: [Signature]
 DATED: 7/29/97



CARRIER SUPPRESSION @ 3.1 GHz
FOR PS-90-2040

AS MEASURED BY YOGESH PATEL OF NAVAL AVIONICS WARFARE CENTER, POINT MUGU, CA.

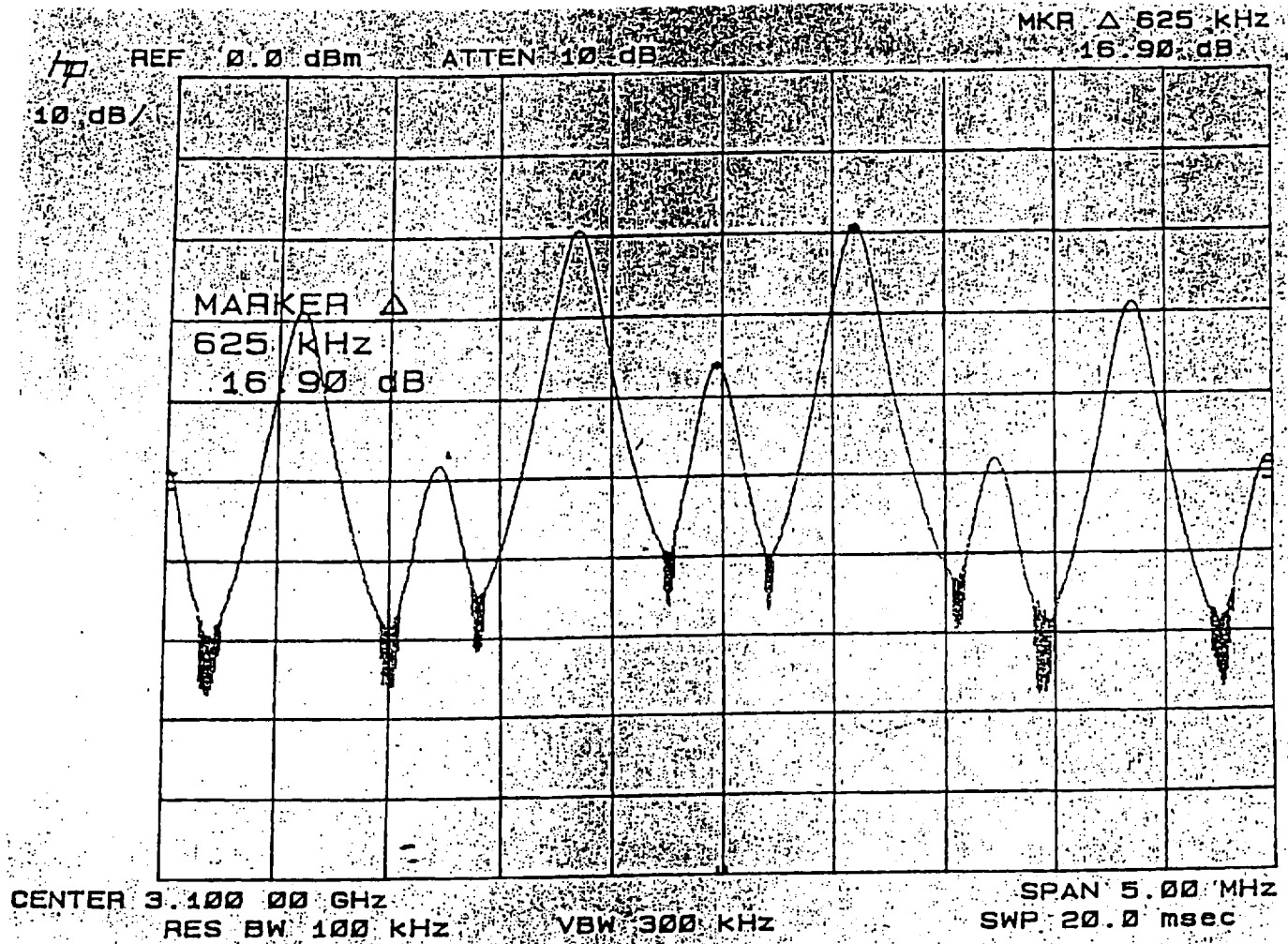

PLANAR MONOLITHICS INDUSTRIES, INC.

CORPORATE & ENGINEERING OFFICES: 1112 PERKIOMENVILLE ROAD, PERKIOMENVILLE, PA 18074
SALES & MANUFACTURING OFFICE: 7311-G GROVE ROAD, FREDERICK, MD 21704
TEL No: 301-662-4700 • FAX No: 301-662-4938 • E-MAIL: AMCPMI@AOL.COM

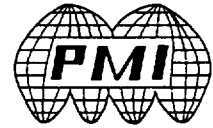

CARRIER SUPPRESSION @ 3.1 GHz
FOR PS-90-2040

AS MEASURED BY YOGESH PATEL OF NAVAL AVIONICS WARFARE CENTER, POINT MUGU, CA.

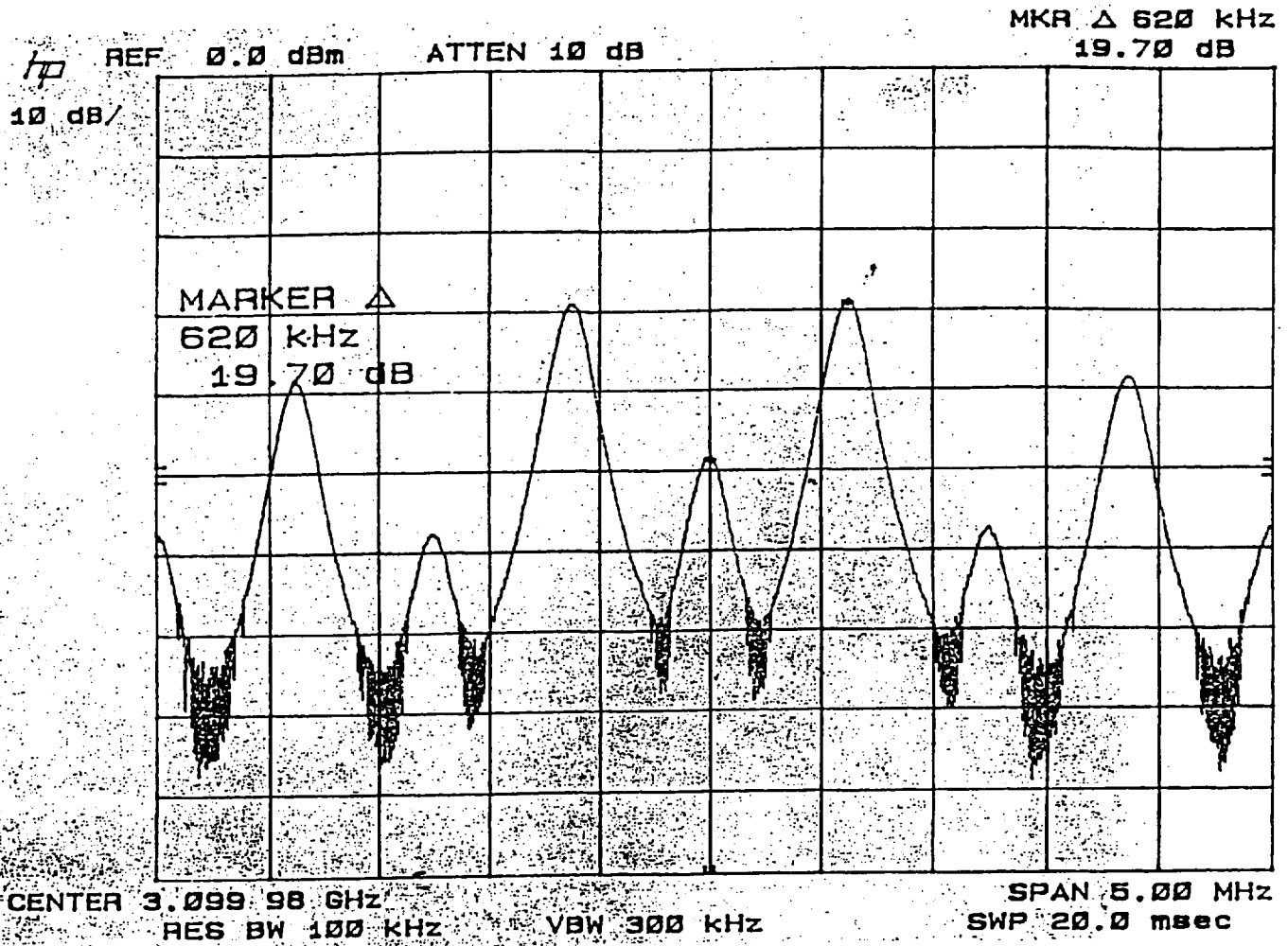

PLANAR MONOLITHICS INDUSTRIES, INC.

CORPORATE & ENGINEERING OFFICES: 1112 PERKIOMENVILLE ROAD, PERKIOMENVILLE, PA 18074
SALES & MANUFACTURING OFFICE: 7311-G GROVE ROAD, FREDERICK, MD 21704
TEL No: 301-662-4700 • FAX No: 301-662-4938 • E-MAIL: AMCPMI@AOL.COM

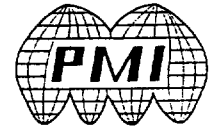

CARRIER SUPPRESSION @ 3.1 GHz
FOR PS-90-2040

SERIAL NUMBER: PM70512, AS MEASURED BY PMI

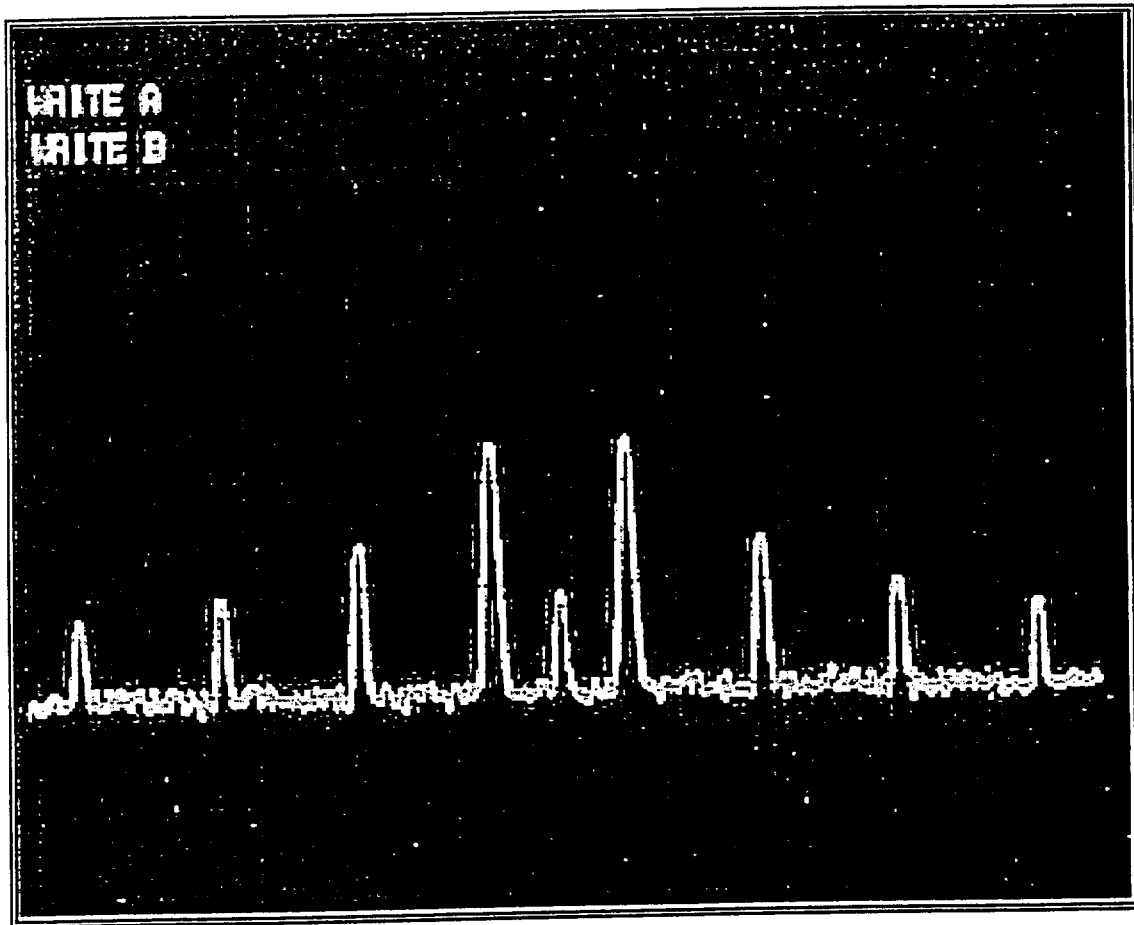

- ◆ 625 KHz PULSE
- ◆ 1.6 μ S PULSE WIDTH
- ◆ SPECTRUM ANALYSER SETTING :
 - ▶ 500 MHz FREQUENCY SPAN
 - ▶ RESOLUTION BANDWIDTH OF 30 MHz
 - ▶ CENTER FREQUENCY 3.1 Ghz
 - ▶ 10 dB PER DIVISION

PLANAR MONOLITHICS INDUSTRIES, INC.

CORPORATE & ENGINEERING OFFICES: 1112 PERKIOMENVILLE ROAD, PERKIOMENVILLE, PA 18074
SALES & MANUFACTURING OFFICE: 7311-G GROVE ROAD, FREDERICK, MD 21704
TEL No: 301-662-4700 • FAX No: 301-662-4938 • E-MAIL: AMCPMI@AOL.COM



TEST DATA

ON

6.0 TO 18.0 GHz

MINIATURE

SINGLE BALANCED

(DOUBLE BALANCED ALSO AVAILABLE)

+ 90°/-90° OR + 0°/-180°

**BI-PHASE MODULATOR/SHIFTER
WITH TTL CONTROL LOGIC**

(ECL CONTROL LOGIC ALSO AVAILABLE)

PMI MODEL NO:

PS-90-8018

(6.0 TO 18.0 GHz, 10.1 TO 10.9 GHz)

SERIAL NO: MC30984

DESIGNED

BY

A. K. GORWARA

TESTED

BY

R. AFABLE

REPORTED

BY

P. WOOD

MARCH 13, 1998

PLANAR MONOLITHICS INDUSTRIES, INC.

CORPORATE & ENGINEERING OFFICES: 1112 PERKIOMENVILLE ROAD, PERKIOMENVILLE, PA 18074

SALES & MANUFACTURING OFFICE: 7311-G GROVE ROAD, FREDERICK, MD 21704

TEL No: 301-662-4700 • FAX No: 301-662-4938 • E-MAIL: AMCPMI@AOL.COM



INSERTION LOSS AND RETURN LOSS

J1-J2 LOGIC "0"

SERIAL NUMBER: MC30984
AS MEASURED OVER 2.0 TO 18.0 GHz
READINGS TAKEN AT 18.0 GHz

CH1: A -M - 1.59 dB CH2: B -M - 12.29 dB
1.0 dB/ REF - 2.50 dB 5.0 dB/ REF - 9.94 dB

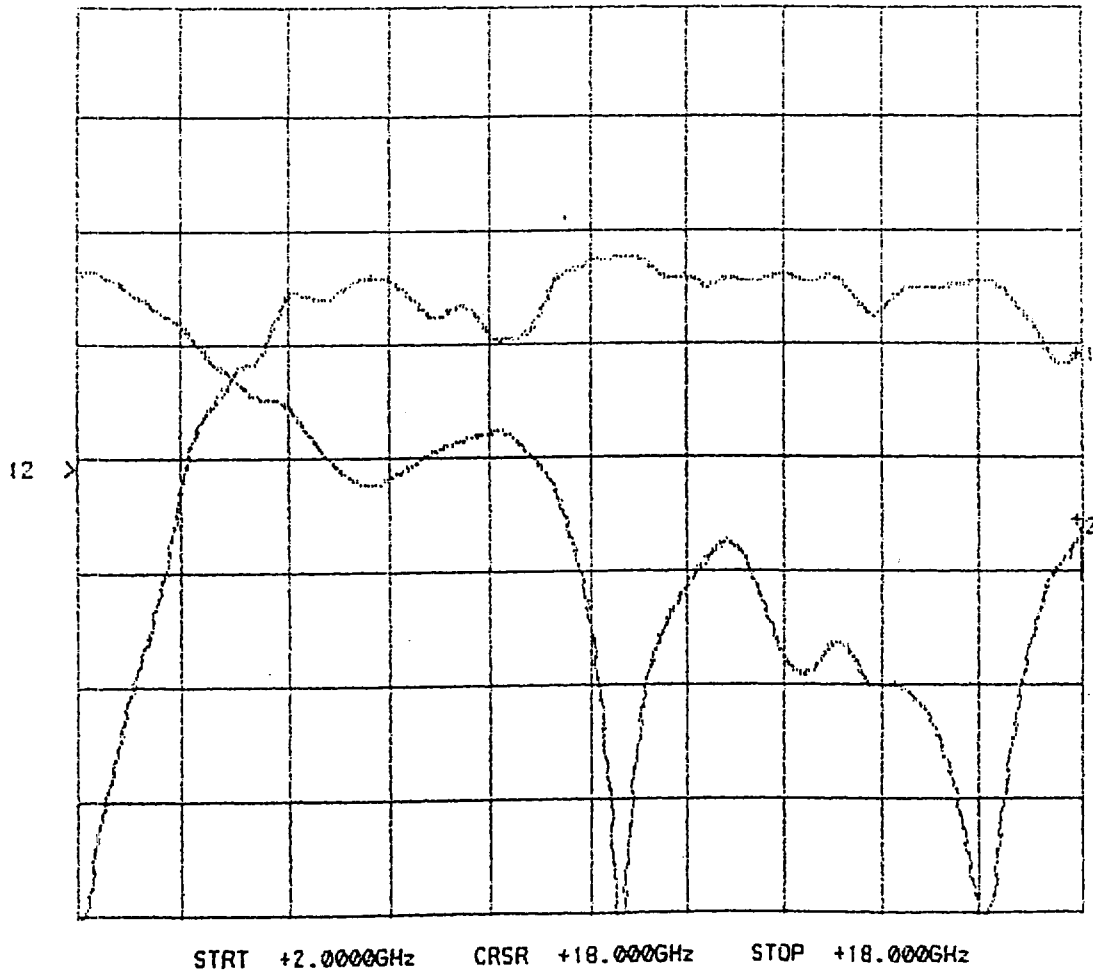

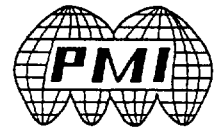

INSERTION LOSS AND RETURN LOSS

J1-J2 LOGIC "1"

SERIAL NUMBER: MC30984

AS MEASURED OVER 2.0 TO 18.0 GHz

READINGS TAKEN AT 18.0 GHz

| | | | | | |
|-------------|---|---------|-------------|---|----------|
| CH1: A -M | - | 2.62 dB | CH2: B -M | - | 12.47 dB |
| 1.0 dB/ REF | - | 2.50 dB | 5.0 dB/ REF | - | 9.54 dB |

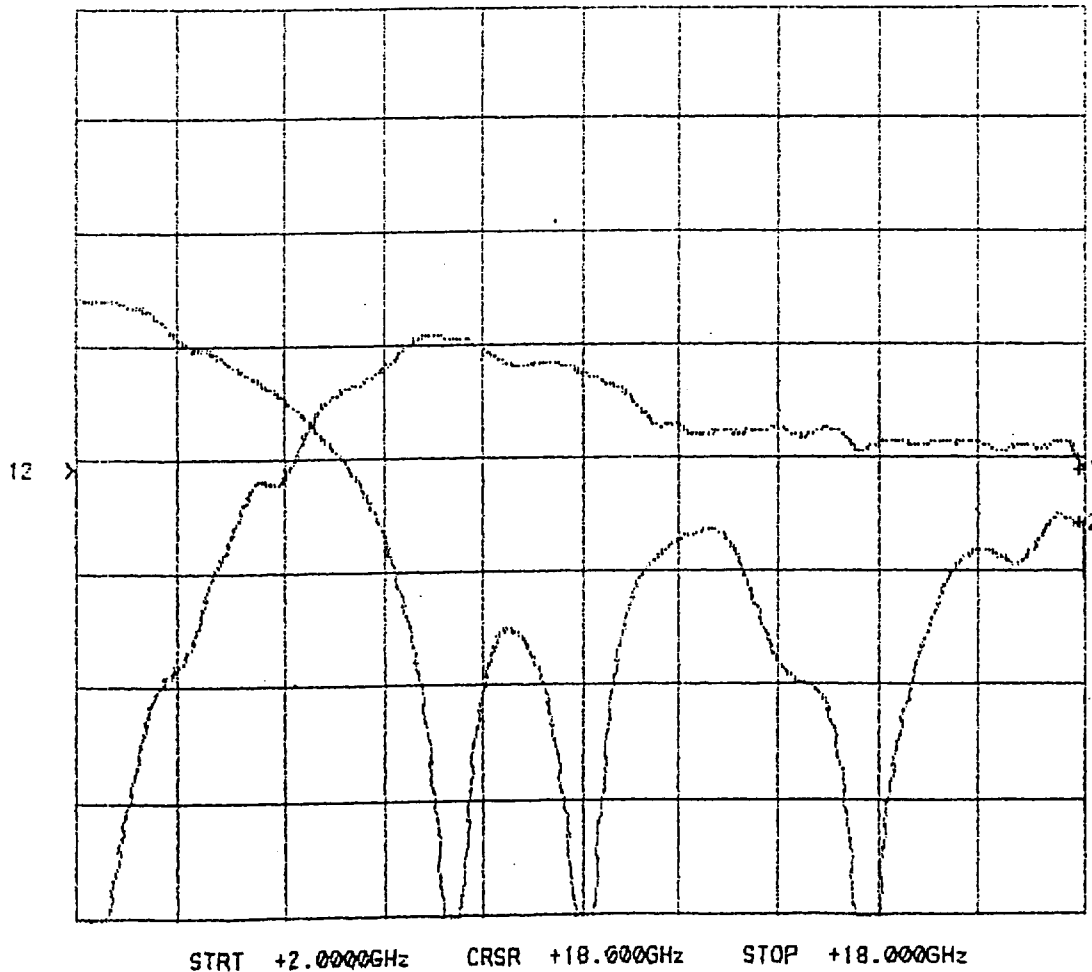

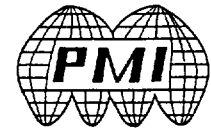

INSERTION LOSS AND RETURN LOSS

J1-J2 LOGIC "0"

SERIAL NUMBER: MC30984
AS MEASURED OVER 2.0 TO 18.0 GHz
READINGS TAKEN AT 6.0 GHz

| | | | | | |
|-------------|---|---------|-------------|---|---------|
| CH1: A -M | - | 1.04 dB | CH2: B -M | - | 9.74 dB |
| 1.0 dB/ REF | - | 2.50 dB | 5.0 dB/ REF | - | 9.54 dB |

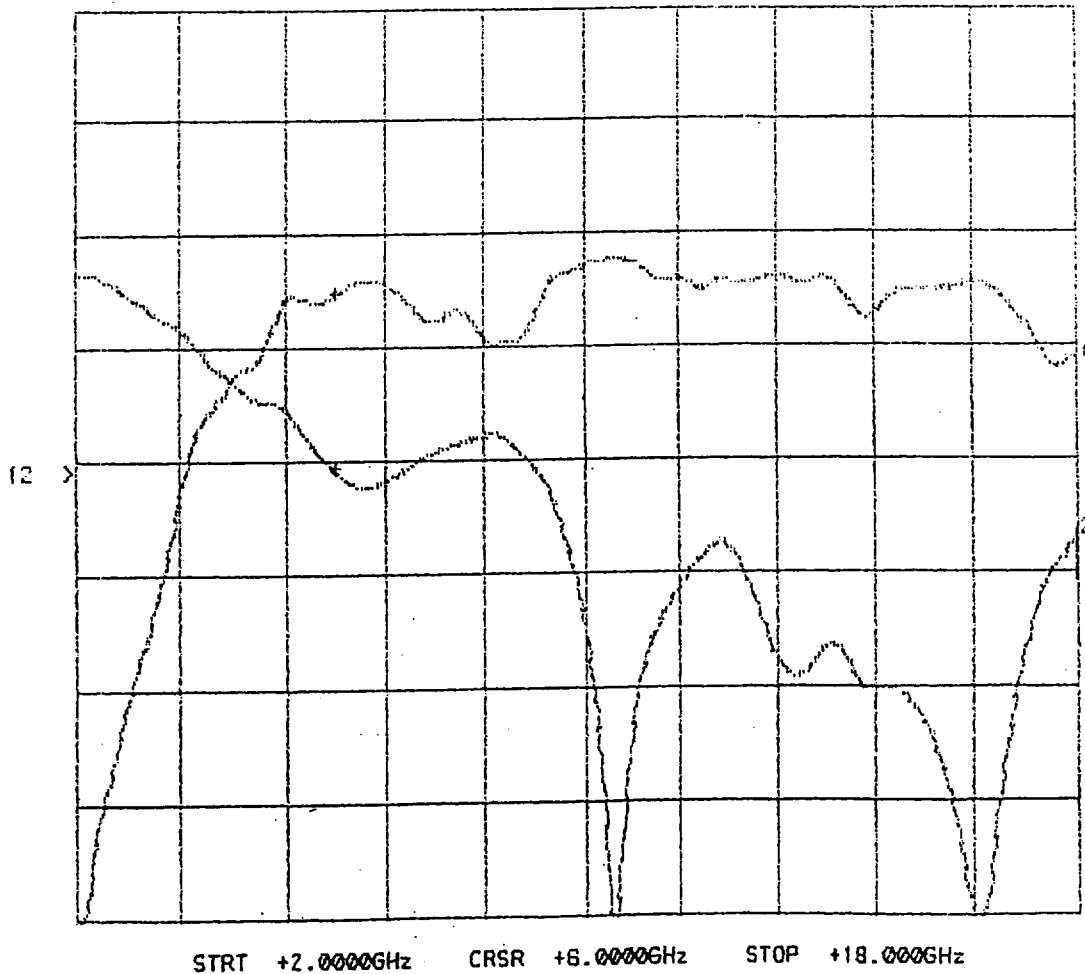

PLANAR MONOLITHICS INDUSTRIES, INC.

CORPORATE & ENGINEERING OFFICES: 1112 PERKIOMENVILLE ROAD, PERKIOMENVILLE, PA 18074
SALES & MANUFACTURING OFFICE: 7311-G GROVE ROAD, FREDERICK, MD 21704
TEL No: 301-662-4700 • FAX No: 301-662-4938 • E-MAIL: AMCPMI@AOL.COM

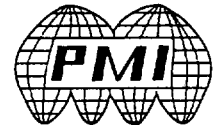

INSERTION LOSS AND RETURN LOSS

J1-J2 LOGIC "1"

SERIAL NUMBER: MC30984
AS MEASURED OVER 2.0 TO 18.0 GHz
READINGS TAKEN AT 6.0 GHz

| | | | | | |
|-------------|---|---------|-------------|---|---------|
| CH1: A -M | - | 1.96 dB | CH2: S -M | - | 9.87 dB |
| 1.0 dB/ REF | - | 2.50 dB | 5.0 dB/ REF | - | 9.54 dB |

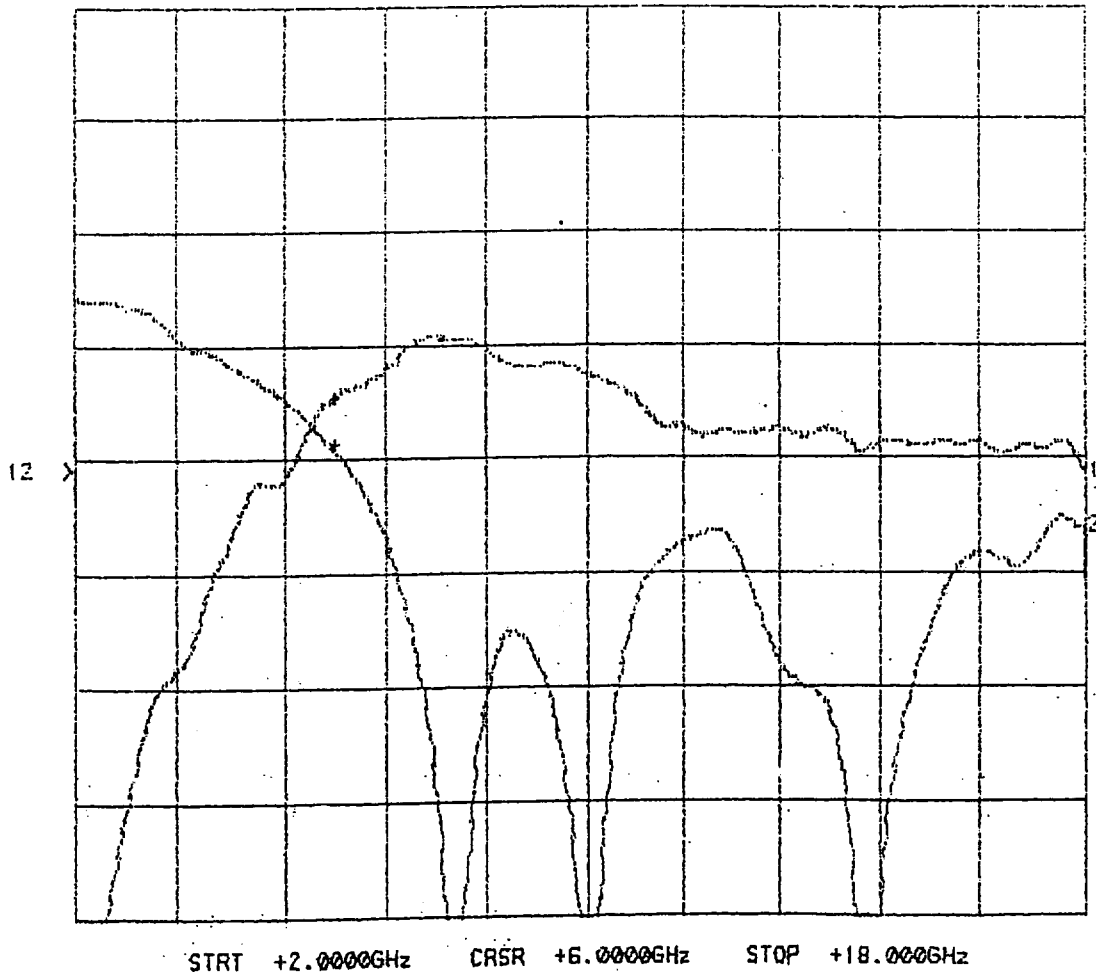

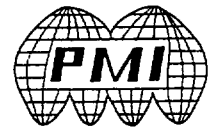

INSERTION LOSS AND RETURN LOSS

J2-J1 LOGIC "0"

SERIAL NUMBER: MC30984
AS MEASURED OVER 2.0 TO 18.0 GHz
READINGS TAKEN AT 18.0 GHz

CH1: A -M S - 1.60 dB CH2: B -M REF - 15.00 dB
1.0 dB/ REF - 2.50 dB 5.0 dB/ REF - 0.04 dB

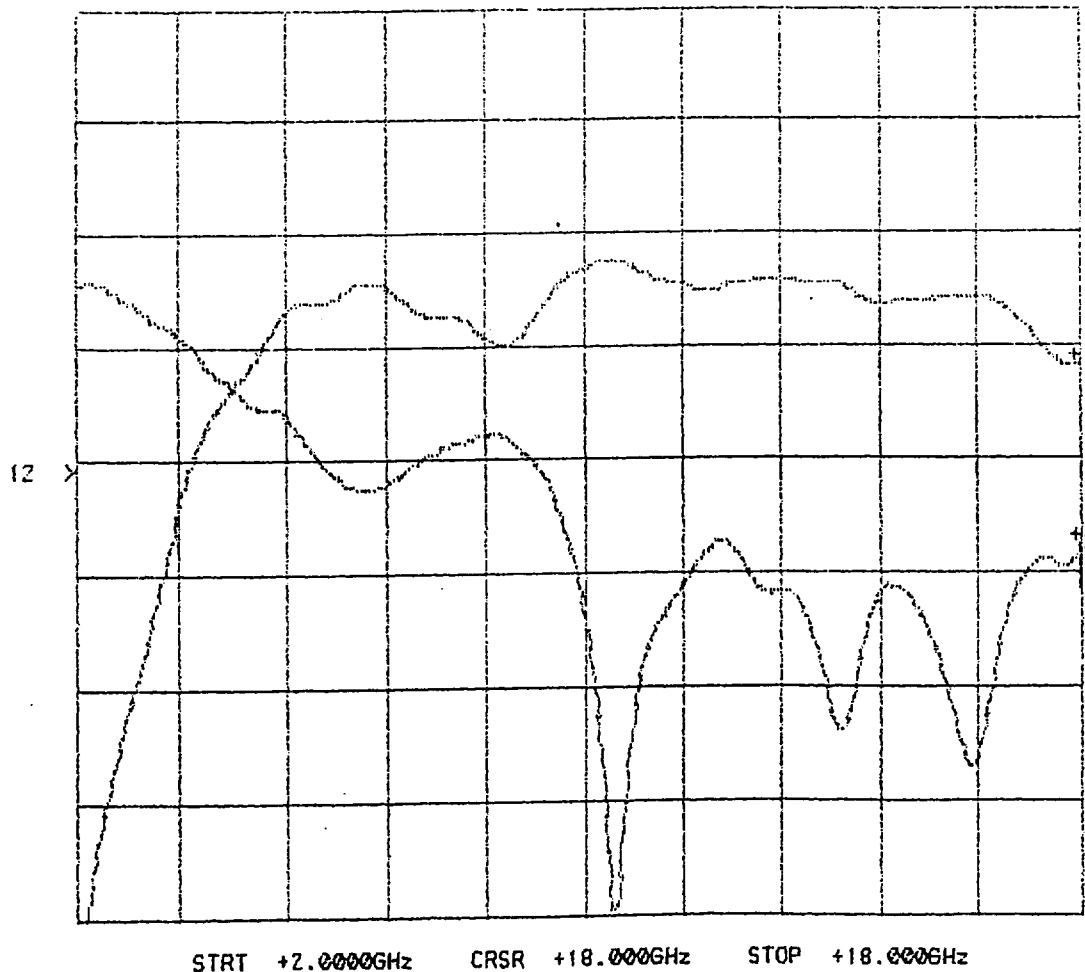

PLANAR MONOLITHICS INDUSTRIES, INC.

CORPORATE & ENGINEERING OFFICES: 1112 PERKIOMENVILLE ROAD, PERKIOMENVILLE, PA 18074
SALES & MANUFACTURING OFFICE: 7311-G GROVE ROAD, FREDERICK, MD 21704
TEL No: 301-662-4700 • FAX No: 301-662-4938 • E-MAIL: AMCPMI@AOL.COM



INSERTION LOSS AND RETURN LOSS
J2-J1 LOGIC "1"

SERIAL NUMBER: MC30984
AS MEASURED OVER 2.0 TO 18.0 GHz
READINGS TAKEN AT 18.0 GHz

CH1: A -M S - 2.56 dB CH2: B -M - 15.65 dB
1.0 dB/ REF - 2.50 dB 5.0 dB/ REF - 9.54 dB

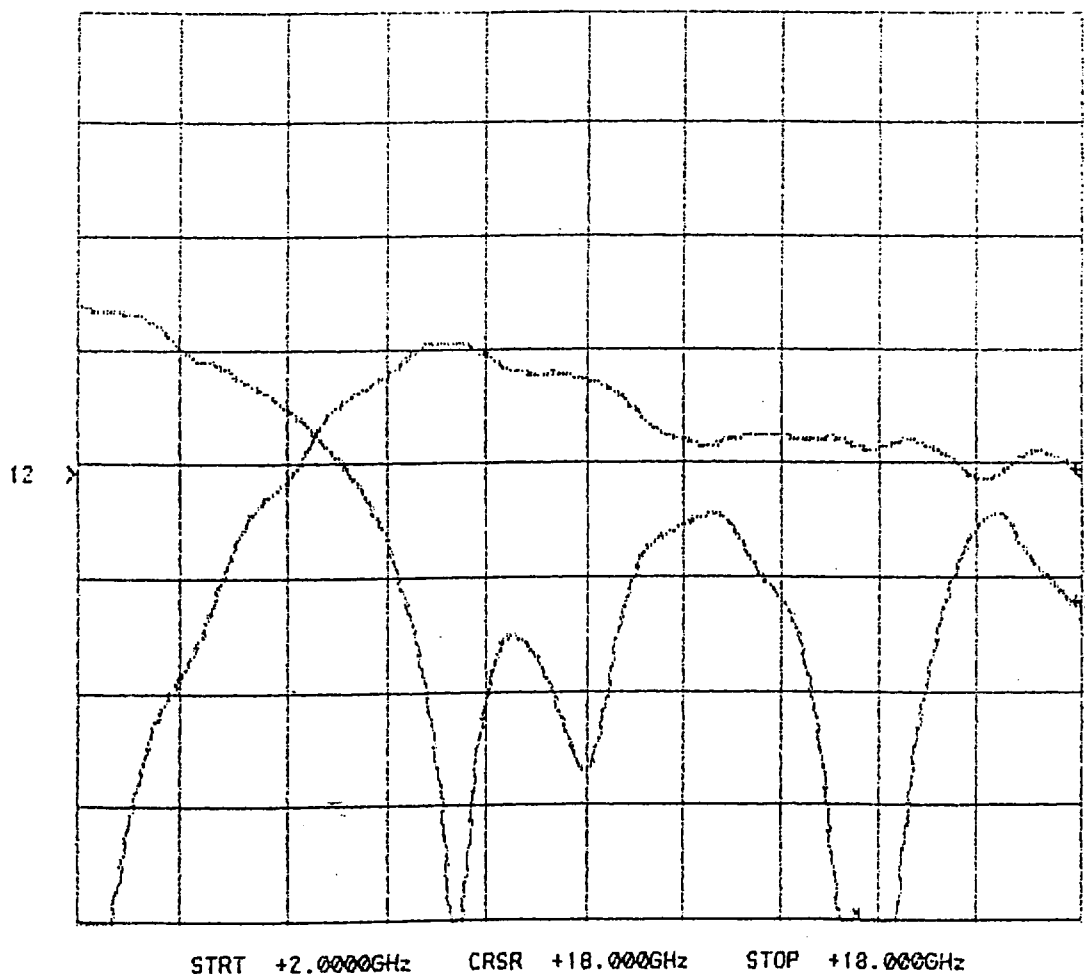



INSERTION LOSS AND RETURN LOSS

J2-J1 LOGIC "0"

SERIAL NUMBER: MC30984

AS MEASURED OVER 2.0 TO 18.0 GHz

READINGS TAKEN AT 6.0 GHz

CH1: A -M S - 1.04 dB CH2: B -M - 10.01 dB
1.0 dB/ REF - 2.50 dB 5.0 dB/ REF - 9.54 dB

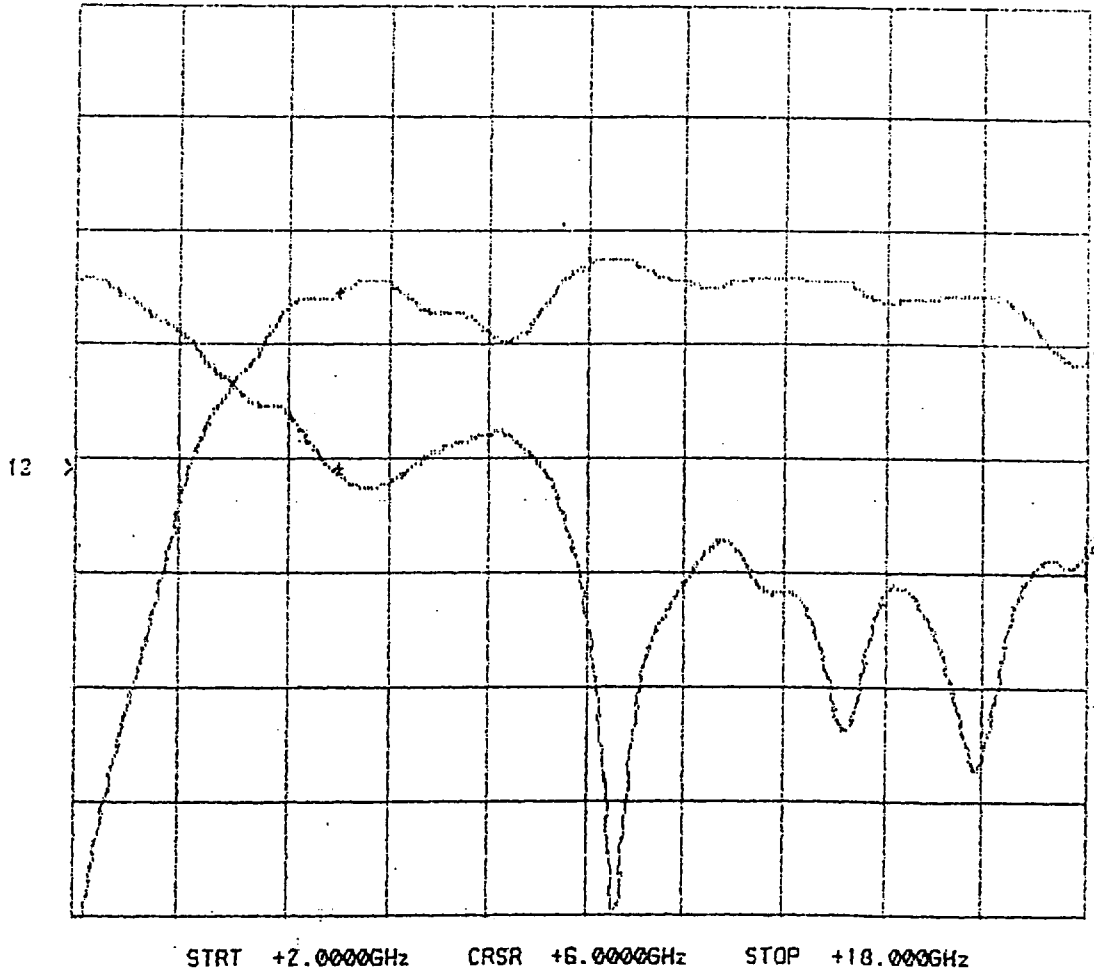

PLANAR MONOLITHICS INDUSTRIES, INC.

CORPORATE & ENGINEERING OFFICES: 1112 PERKIOMENVILLE ROAD, PERKIOMENVILLE, PA 18074

SALES & MANUFACTURING OFFICE: 7311-G GROVE ROAD, FREDERICK, MD 21704

TEL No: 301-662-4700 • FAX No: 301-662-4938 • E-MAIL: AMCPMI@AOL.COM



INSERTION LOSS AND RETURN LOSS

J2-J1 LOGIC "1"

SERIAL NUMBER: MC30984
AS MEASURED OVER 2.0 TO 18.0 GHz
READINGS TAKEN AT 6.0 GHz

CH1: A -M S - 2.01 dB CH2: B -M - 9.95 dB
1.0 dB/ REF - 2.50 dB 5.0 dB/ REF - 9.54 dB

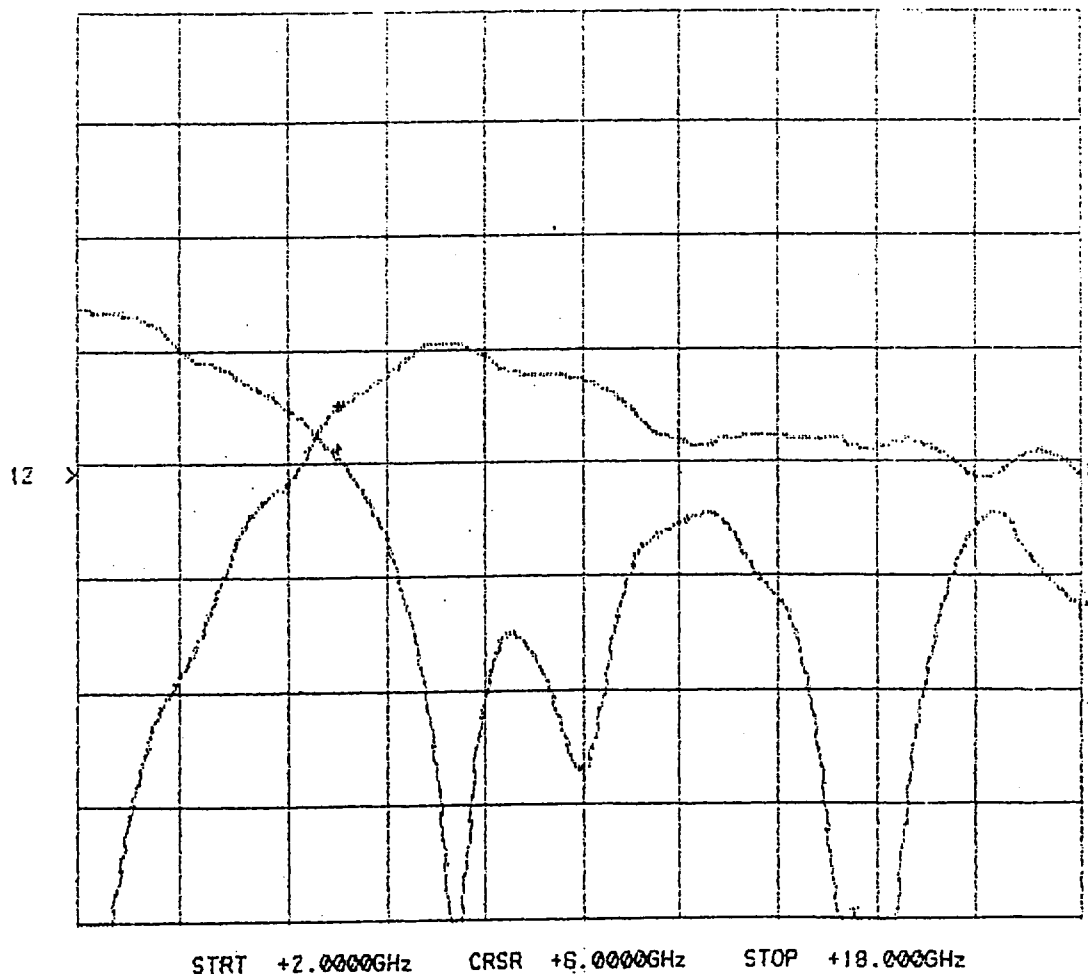

PLANAR MONOLITHICS INDUSTRIES, INC.

CORPORATE & ENGINEERING OFFICES: 1112 PERKIOMENVILLE ROAD, PERKIOMENVILLE, PA 18074
SALES & MANUFACTURING OFFICE: 7311-G GROVE ROAD, FREDERICK, MD 21704
TEL No: 301-662-4700 • FAX No: 301-662-4938 • E-MAIL: AMCPMI@AOL.COM



INSERTION LOSS AND RETURN LOSS

J1-J2 LOGIC "0"

SERIAL NUMBER: MC30984
AS MEASURED OVER 10.1 TO 10.9 GHz
READINGS TAKEN AT 10.9 GHz

| | | | | | |
|-------------|---|---------|-------------|---|----------|
| CH1: A -M | - | .78 dB | CH2: B -M | - | 18.95 dB |
| 1.0 dB/ REF | - | 2.50 dB | 5.0 dB/ REF | - | 3.54 dB |

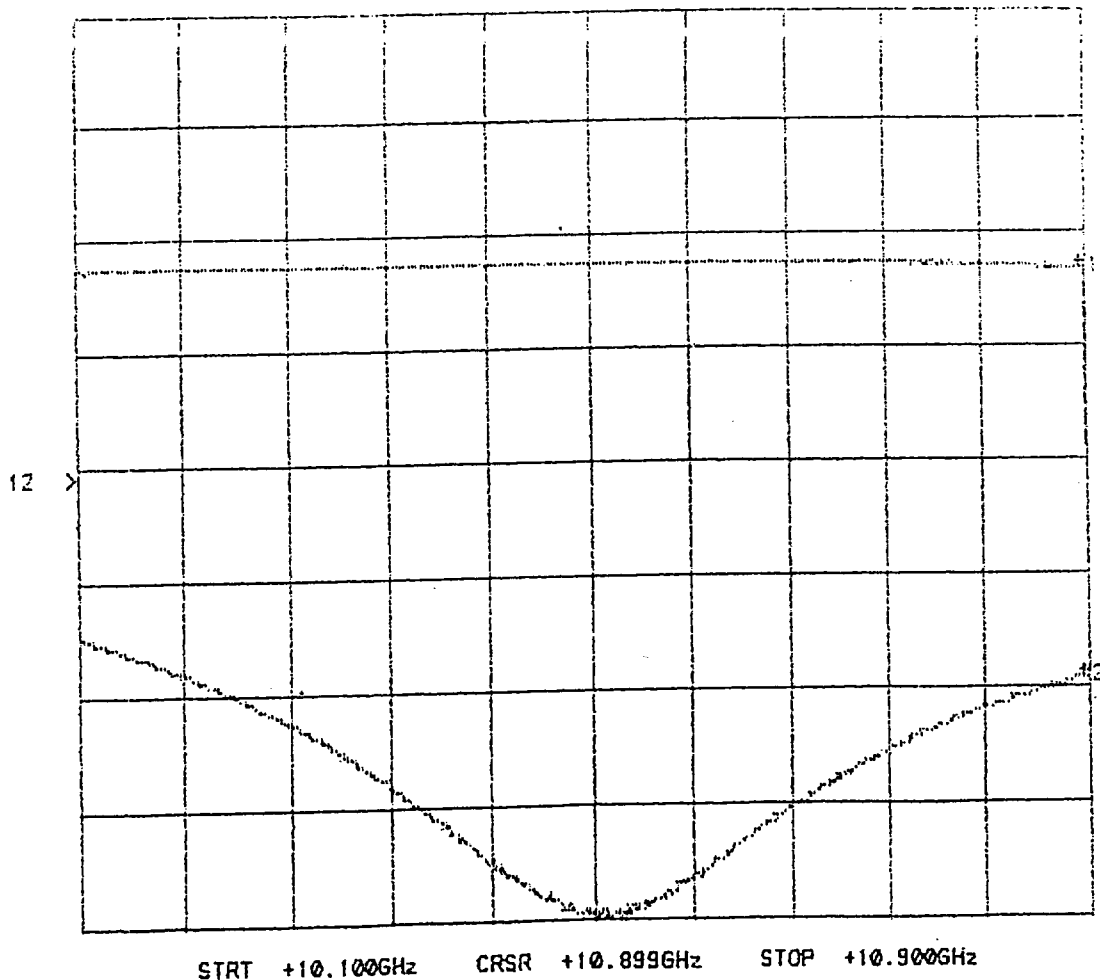



INSERTION LOSS AND RETURN LOSS

J1-J2 LOGIC "1"

SERIAL NUMBER: MC30984
AS MEASURED OVER 10.1 TO 10.9 GHz
READINGS TAKEN AT 10.9 GHz

CH1: A -M - 2.02 dB CH2: B -M - 13.53 dB
1.0 dB/ REF - 2.50 dB 5.0 dB/ REF - 9.54 dB

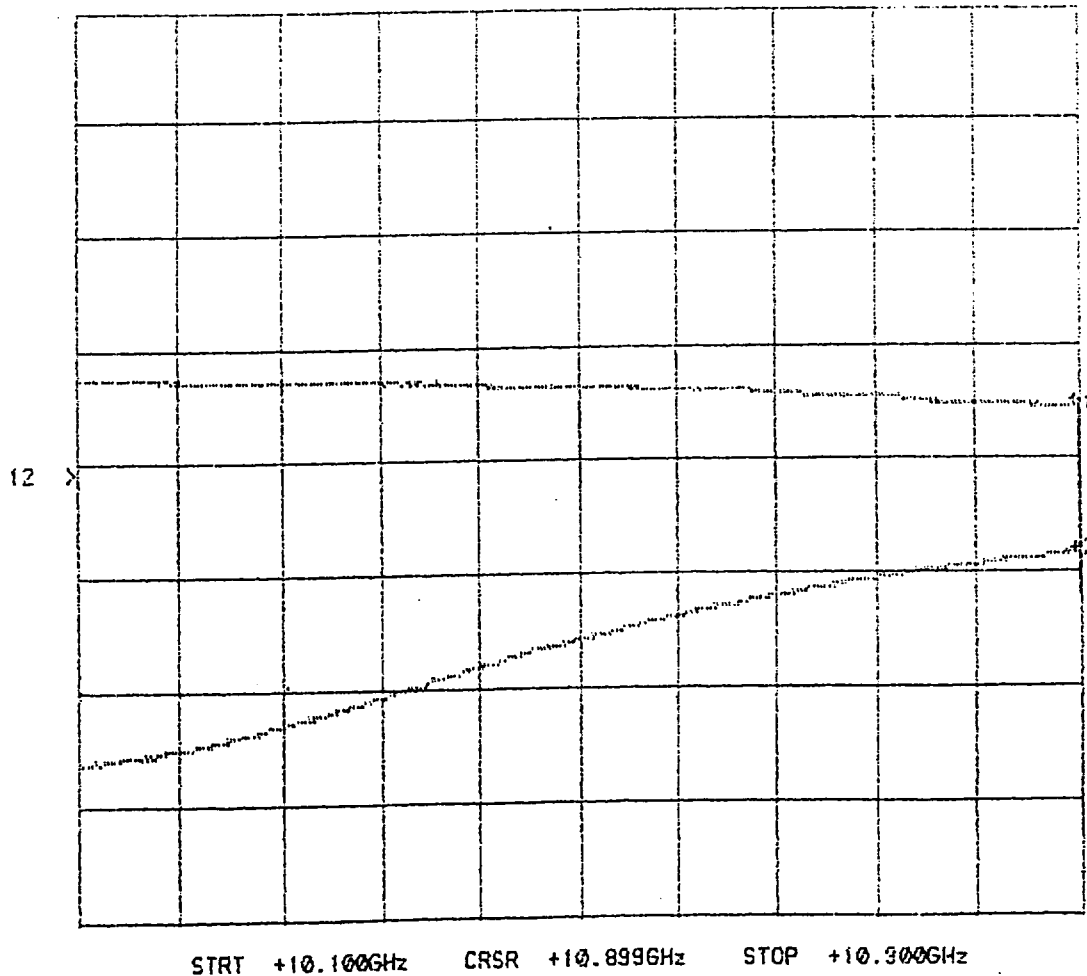

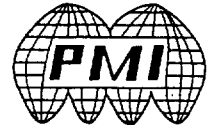

TYPICAL TEST DATA
 AS MEASURED FROM 10.2 TO 10.8 GHz

FORM: PS-1/0993



PHASE SHIFTER TEST DATA

JOBNO: 308194-2E MODELNO: PS-90 SERIALNO: MC30984
 CUSTOMER: Martin Marietta TECHNICIAN: R.A.
 SPECIFICATION: _____ FREQUENCY RANGE: 10.2 - 10.8 GHz

| INSERTION LOSS | VSWR | LOGIC |
|----------------|-----------|-------|
| J1-J2 0.78 dB | -18.98 dB | "1" |
| J1-J2 2.02 dB | -13.63 dB | "0" |
| | | |
| | | |
| | | |
| | | |
| | | |
| | | |
| | | |

NOTE: ANY ADDITIONAL TEST DATA WRITE ON BACK PAGE.

TESTED BY: f. f. f.
 QA/QC: _____
 DATED: _____



TEST DATA

ON

6.0 TO 18.0 GHz

MINIATURE

SINGLE BALANCED

(DOUBLE BALANCED ALSO AVAILABLE)

$+90^\circ/-90^\circ$ OR $+0^\circ/-180^\circ$

BI-PHASE MODULATOR/SHIFTER
WITH TTL CONTROL LOGIC

(ECL CONTROL LOGIC ALSO AVAILABLE)

PMI MODEL NO:

PS-90-8018

(6.0 TO 18.0 GHz, 10.1 TO 10.9 GHz)

SERIAL NO: MC30986

DESIGNED

BY

A. K. GORWARA

TESTED

BY

R. AFABLE

REPORTED

BY

P. WOOD

MARCH 13, 1998

PLANAR MONOLITHICS INDUSTRIES, INC.

CORPORATE & ENGINEERING OFFICES: 1112 PERKIOMENVILLE ROAD, PERKIOMENVILLE, PA 18074
SALES & MANUFACTURING OFFICE: 7311-G GROVE ROAD, FREDERICK, MD 21704
TEL No: 301-662-4700 • FAX No: 301-662-4938 • E-MAIL: AMCPMI@AOL.COM

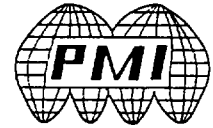

INSERTION LOSS AND RETURN LOSS

J1-J2 LOGIC "0"

SERIAL NUMBER: MC30986
AS MEASURED OVER 2.0 TO 18.0 GHz
READINGS TAKEN AT 18.0 GHz

| | | | | | |
|-------------|---|---------|-------------|---|----------|
| CH1: A -M | - | 1.95 dB | CH2: B -M | - | 12.57 dB |
| 1.0 dB/ REF | - | 2.50 dB | 5.0 dB/ REF | - | 9.54 dB |

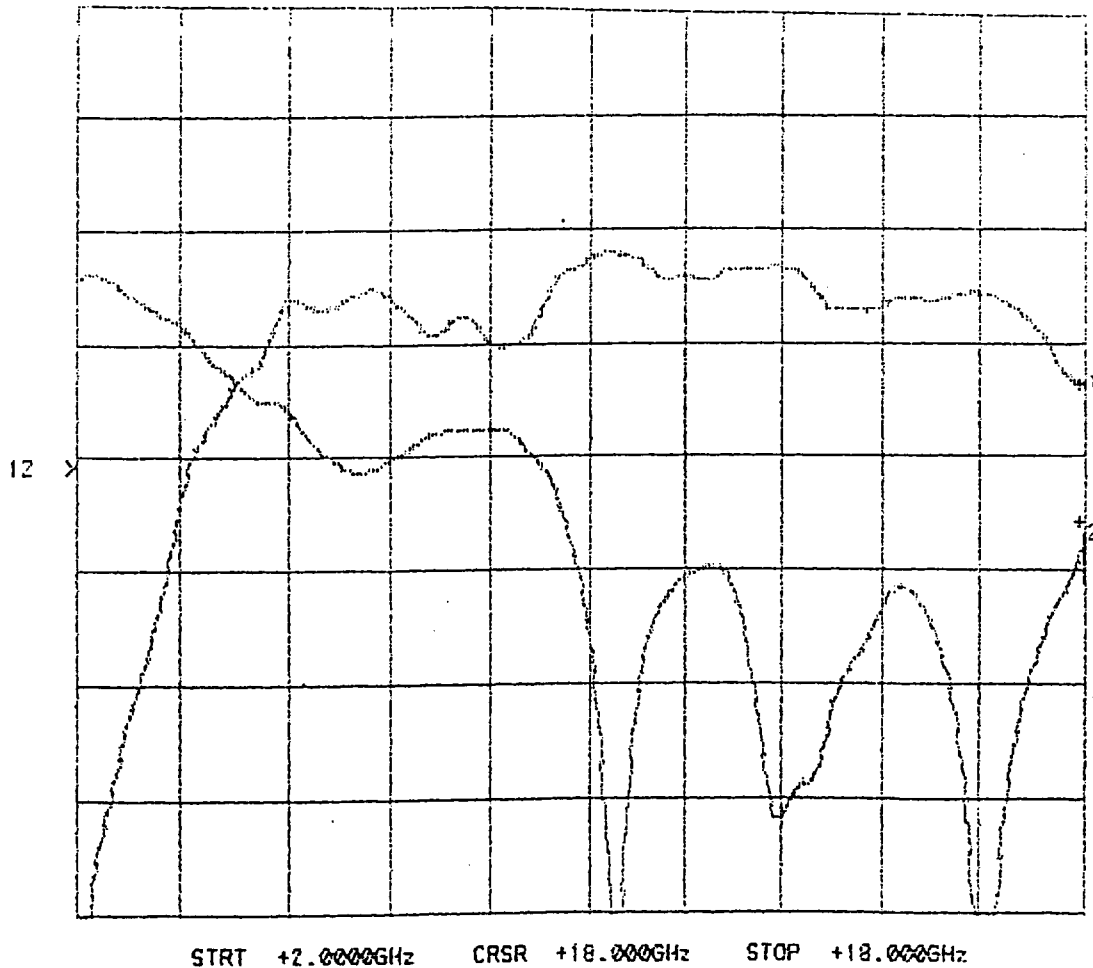

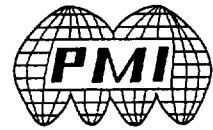

INSERTION LOSS AND RETURN LOSS

J1-J2 LOGIC "1"

SERIAL NUMBER: MC30986
AS MEASURED OVER 2.0 TO 18.0 GHz
READINGS TAKEN AT 18.0 GHz

CH1: A -M - 2.89 dB CH2: B -M - 15.98 dB
1.0 dB/ REF - 2.50 dB 5.0 dB/ REF - 9.54 dB

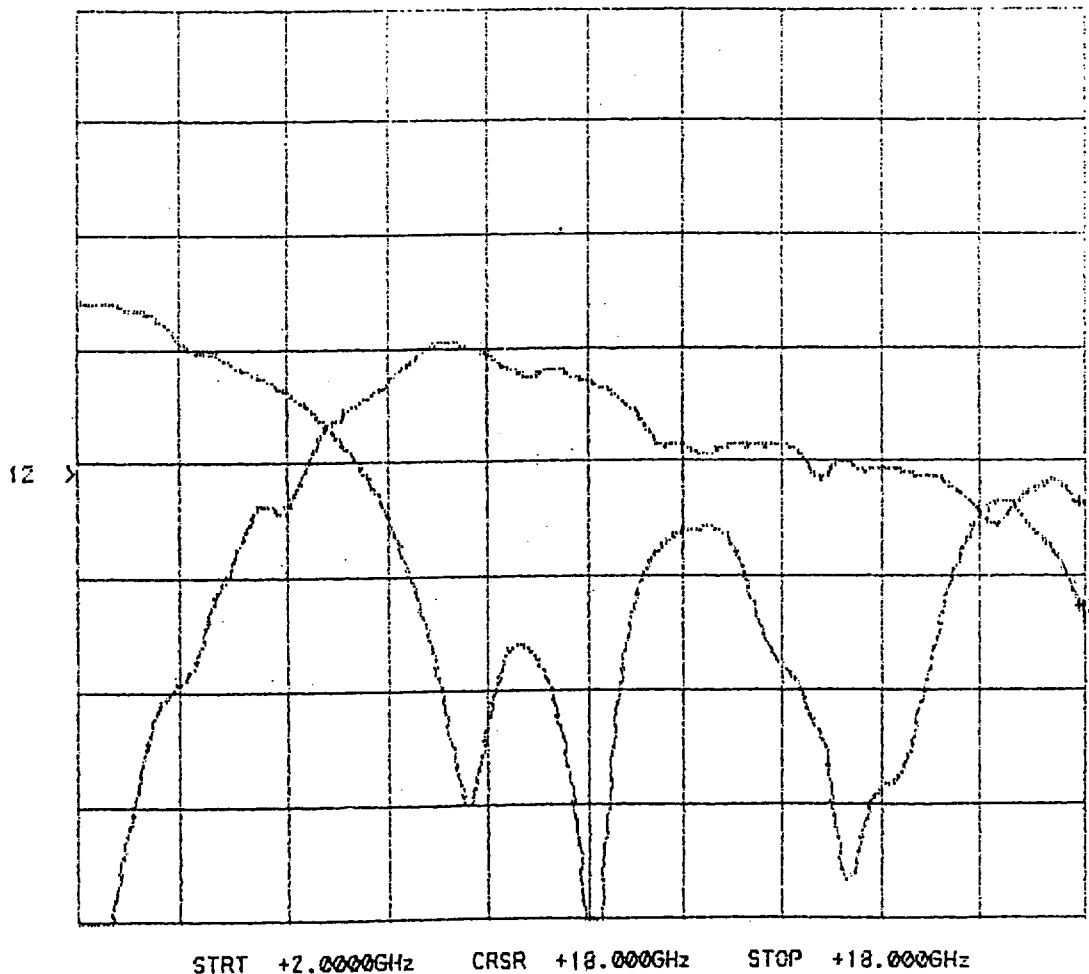

PLANAR MONOLITHICS INDUSTRIES, INC.

CORPORATE & ENGINEERING OFFICES: 1112 PERKIOMENVILLE ROAD, PERKIOMENVILLE, PA 18074
SALES & MANUFACTURING OFFICE: 7311-G GROVE ROAD, FREDERICK, MD 21704
TEL No: 301-662-4700 • FAX No: 301-662-4938 • E-MAIL: AMCPMI@AOL.COM



INSERTION LOSS AND RETURN LOSS

J1-J2 LOGIC "0"

SERIAL NUMBER: MC30986
AS MEASURED OVER 2.0 TO 18.0 GHz
READINGS TAKEN AT 6.0 GHz

CH1: A -M - 1.12 dB CH2: B -M - 9.55 dB
1.0 dB/ REF - 2.50 dB 5.0 dB/ REF - 9.54 dB

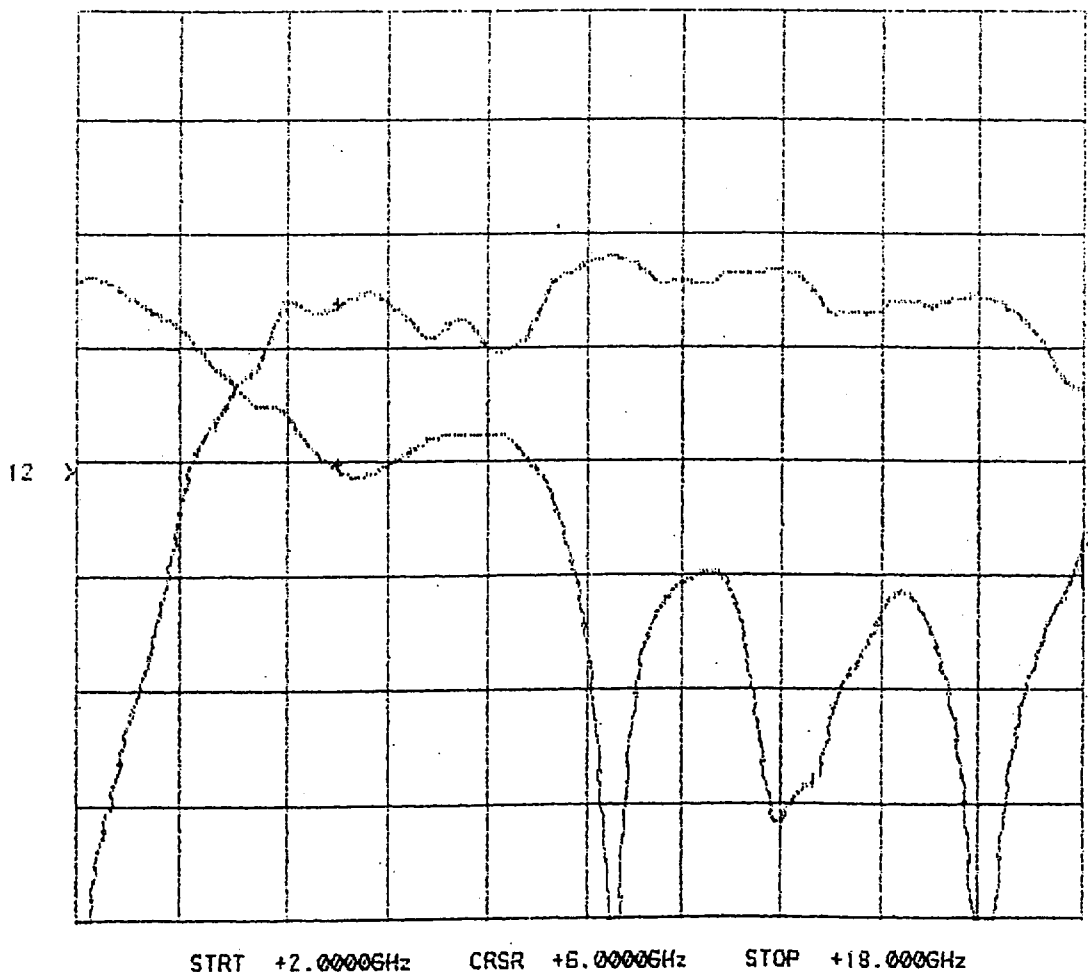

PLANAR MONOLITHICS INDUSTRIES, INC.

CORPORATE & ENGINEERING OFFICES: 1112 PERKIOMENVILLE ROAD, PERKIOMENVILLE, PA 18074
SALES & MANUFACTURING OFFICE: 7311-G GROVE ROAD, FREDERICK, MD 21704
TEL No: 301-662-4700 • FAX No: 301-662-4938 • E-MAIL: AMCPMI@AOL.COM

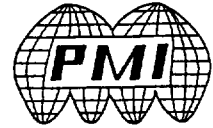

INSERTION LOSS AND RETURN LOSS

J1-J2 LOGIC "1"

SERIAL NUMBER: MC30986
AS MEASURED OVER 2.0 TO 18.0 GHz
READINGS TAKEN AT 6.0 GHz

CH1: A -M - 2.14 dB CH2: B -M - 6.17 dB
1.0 dB/ REF - 2.50 dB 5.0 dB/ REF - 8.64 dB

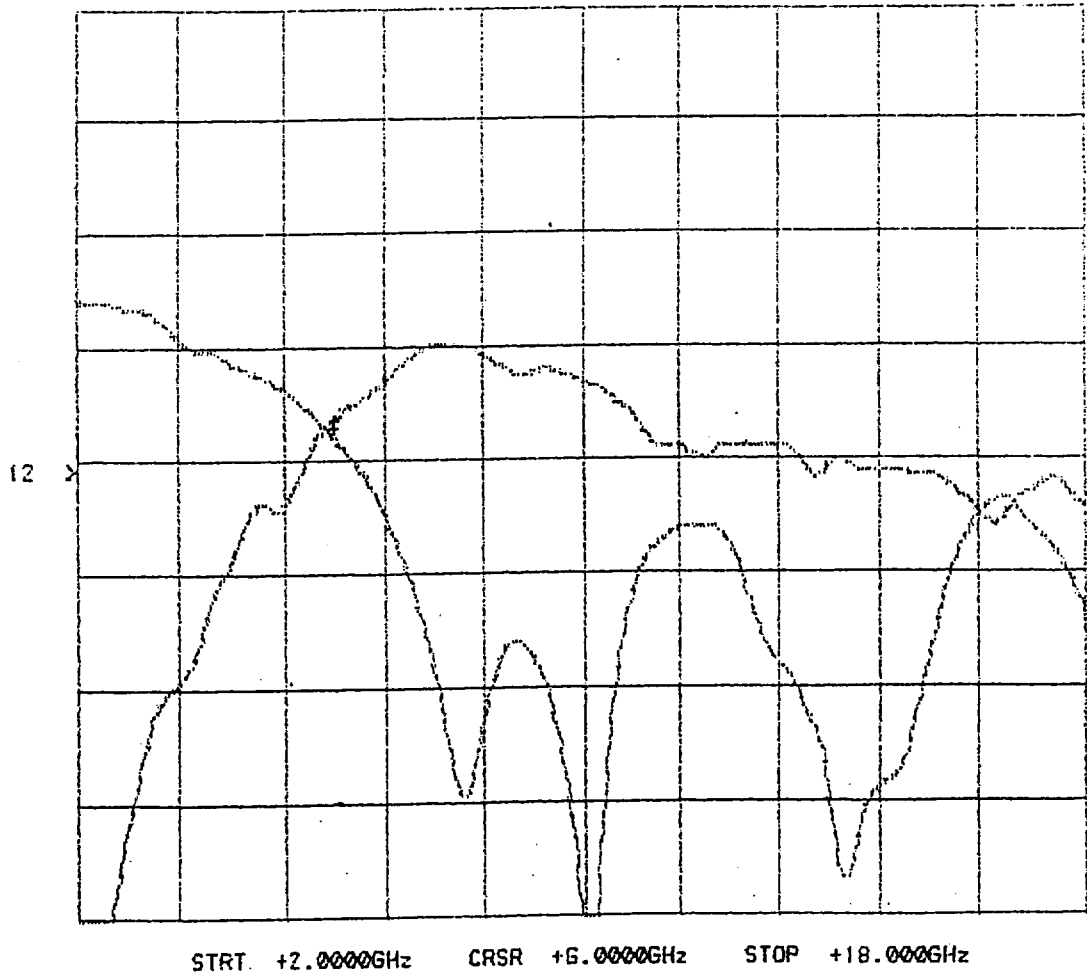

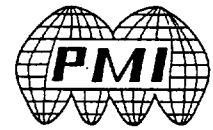

INSERTION LOSS AND RETURN LOSS

J2-J1 LOGIC "0"

SERIAL NUMBER: MC30986
AS MEASURED OVER 2.0 TO 18.0 GHz
READINGS TAKEN AT 18.0 GHz

| | | | | | |
|-------------|---|---------|-------------|---|----------|
| CH1: A -M | - | 1.83 dB | CH2: B -M | - | 11.92 dB |
| 1.0 dB/ REF | - | 2.50 dB | 5.0 dB/ REF | - | 9.54 dB |

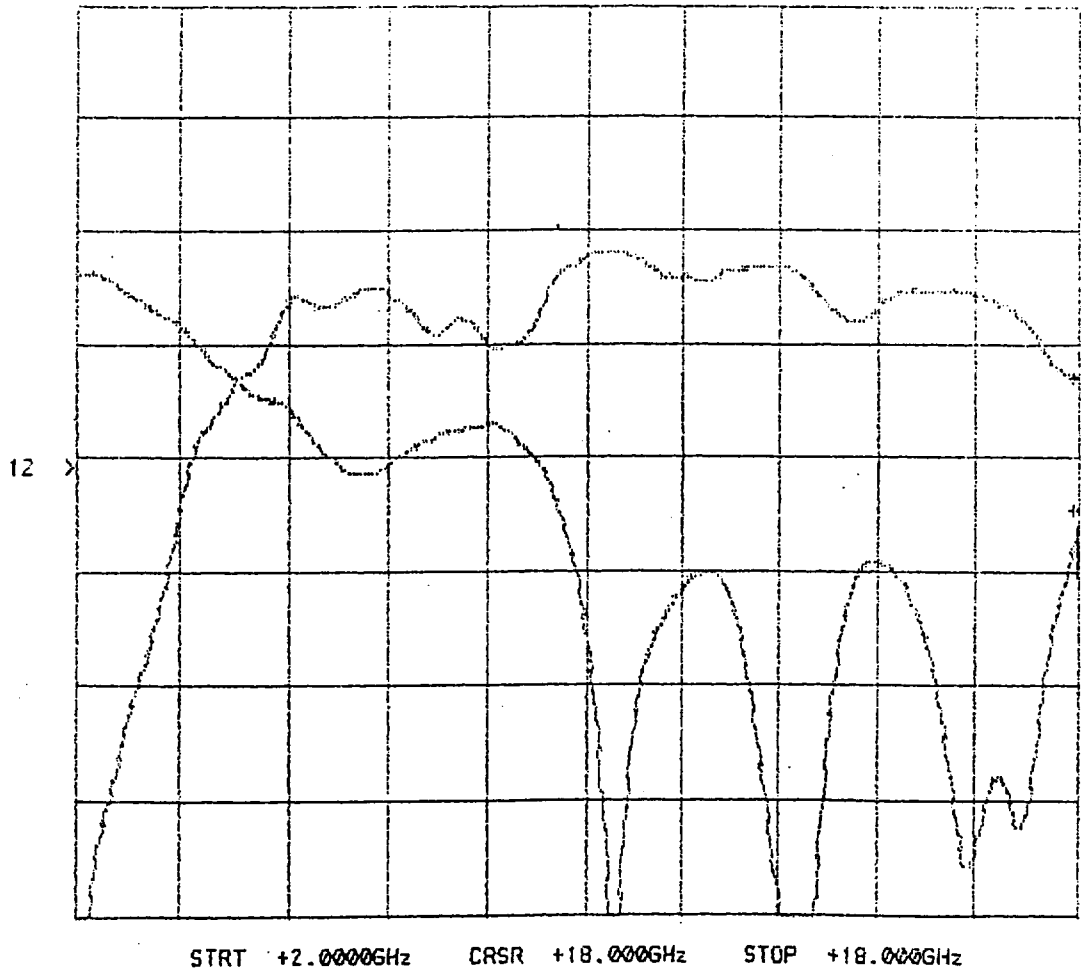

PLANAR MONOLITHICS INDUSTRIES, INC.

CORPORATE & ENGINEERING OFFICES: 1112 PERKIOMENVILLE ROAD, PERKIOMENVILLE, PA 18074
SALES & MANUFACTURING OFFICE: 7311-G GROVE ROAD, FREDERICK, MD 21704
TEL No: 301-662-4700 • FAX No: 301-662-4938 • E-MAIL: AMCPMI@AOL.COM



INSERTION LOSS AND RETURN LOSS

J2-J1 LOGIC "1"

SERIAL NUMBER: MC30986

AS MEASURED OVER 2.0 TO 18.0 GHz

READINGS TAKEN AT 18.0 GHz

| | | | | | |
|-------------|---|---------|-------------|---|----------|
| CH1: A -M | - | 2.90 dB | CH2: B -M | - | 12.23 dB |
| 1.0 dB/ REF | - | 2.50 dB | 5.0 dB/ REF | - | 8.54 dB |

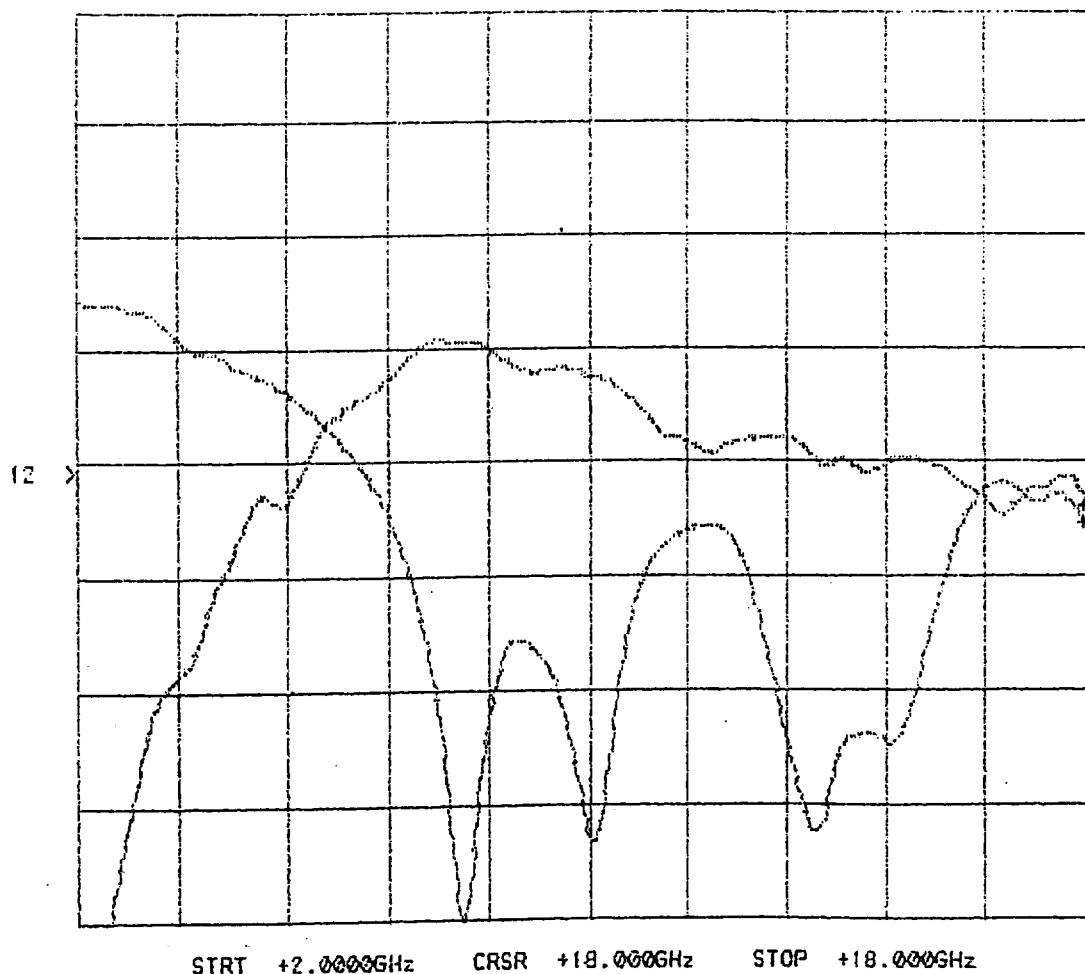

PLANAR MONOLITHICS INDUSTRIES, INC.

CORPORATE & ENGINEERING OFFICES: 1112 PERKIOMENVILLE ROAD, PERKIOMENVILLE, PA 18074

SALES & MANUFACTURING OFFICE: 7311-G GROVE ROAD, FREDERICK, MD 21704

TEL No: 301-662-4700 • FAX No: 301-662-4938 • E-MAIL: AMCPMI@AOL.COM



INSERTION LOSS AND RETURN LOSS

J2-J1 LOGIC "0"

SERIAL NUMBER: MC30986
AS MEASURED OVER 2.0 TO 18.0 GHz
READINGS TAKEN AT 6.0 GHz

| | | | | | |
|-------------|---|---------|-------------|---|---------|
| CH1: A -M | - | 1.10 dB | CH2: B -M | - | 9.63 dB |
| 1.0 dB/ REF | - | 2.50 dB | 5.0 dB/ REF | - | 9.94 dB |

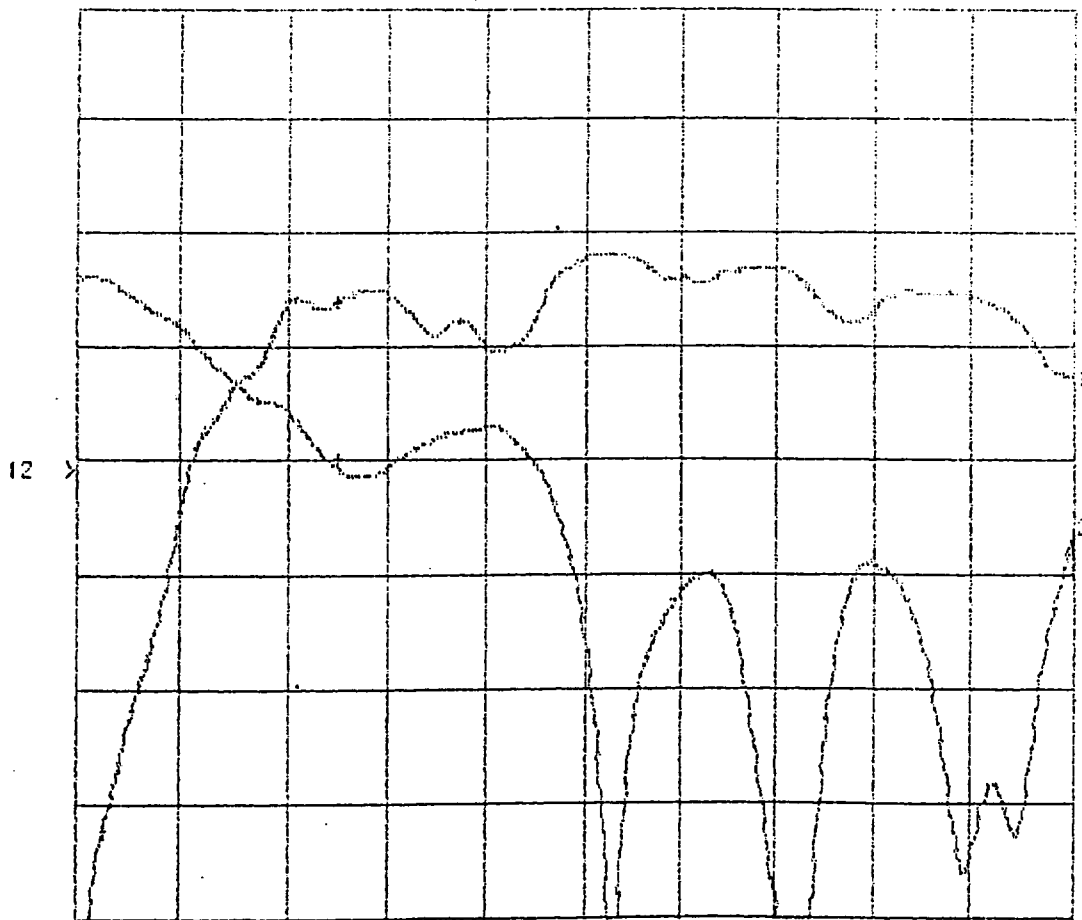

STRT +2.0000GHz CRSR +6.0000GHz STOP +18.000GHz

PLANAR MONOLITHICS INDUSTRIES, INC.

CORPORATE & ENGINEERING OFFICES: 1112 PERKIOMENVILLE ROAD, PERKIOMENVILLE, PA 18074

SALES & MANUFACTURING OFFICE: 7311-G GROVE ROAD, FREDERICK, MD 21704

TEL No: 301-662-4700 • FAX No: 301-662-4938 • E-MAIL: AMCPMI@AOL.COM



INSERTION LOSS AND RETURN LOSS

J2-J1 LOGIC "1"

SERIAL NUMBER: MC30986
AS MEASURED OVER 2.0 TO 18.0 GHz
READINGS TAKEN AT 6.0 GHz

| | | | | | |
|-------------|---|---------|-------------|---|---------|
| CH1: A -M | - | 2.10 dB | CH2: B -M | - | 8.13 dB |
| 1.0 dB/ REF | - | 2.50 dB | 5.0 dB/ REF | - | 8.54 dB |

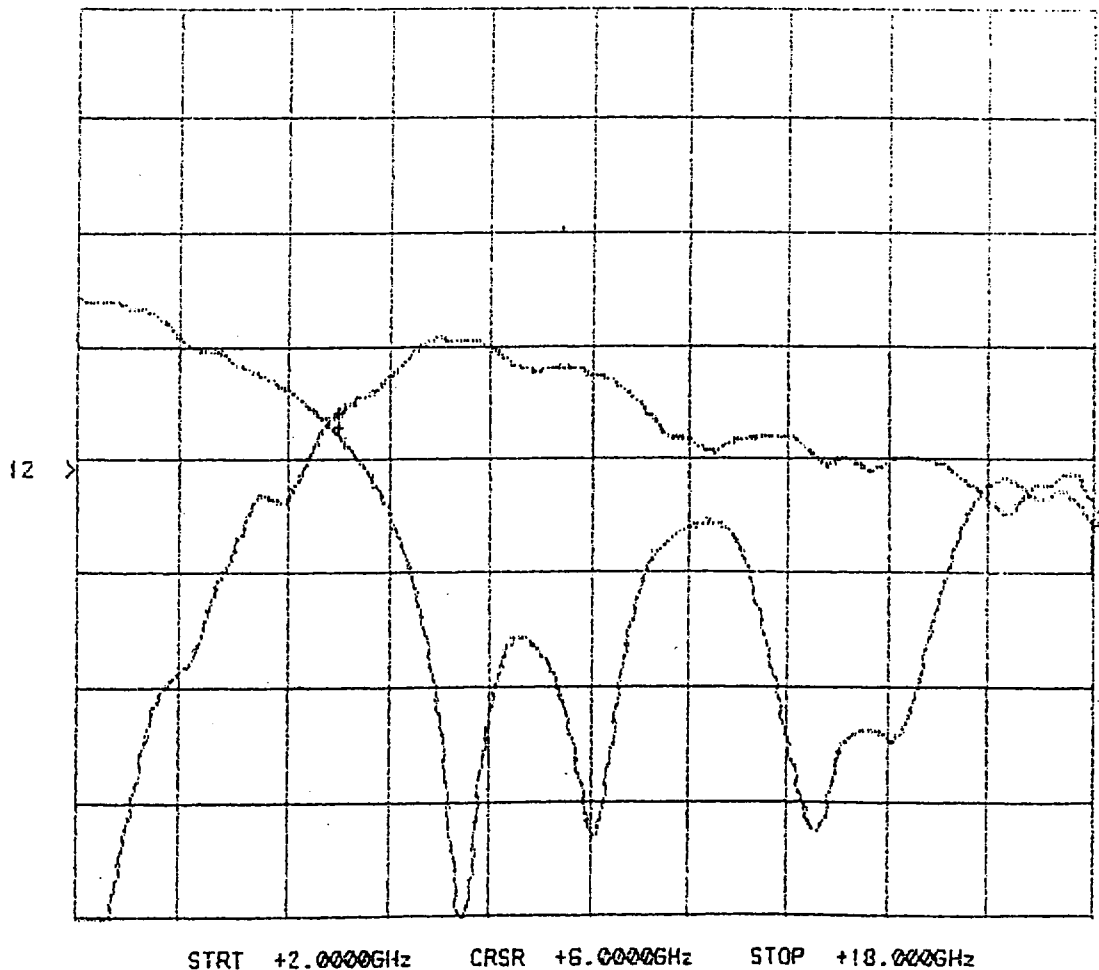

PLANAR MONOLITHICS INDUSTRIES, INC.

CORPORATE & ENGINEERING OFFICES: 1112 PERKIOMENVILLE ROAD, PERKIOMENVILLE, PA 18074
SALES & MANUFACTURING OFFICE: 7311-G GROVE ROAD, FREDERICK, MD 21704
TEL No: 301-662-4700 * FAX No: 301-662-4938 * E-MAIL: AMCPMI@AOL.COM



INSERTION LOSS AND RETURN LOSS

J1-J2 LOGIC "0"

SERIAL NUMBER: MC30986
AS MEASURED OVER 10.1 TO 10.9 GHz
READINGS TAKEN AT 10.9 GHz

CH1: A -M - 1.92 dB
1.0 dB/ REF - 2.50 dB
CH2: B -M - 19.37 dB
5.0 dB/ REF - 9.54 dB

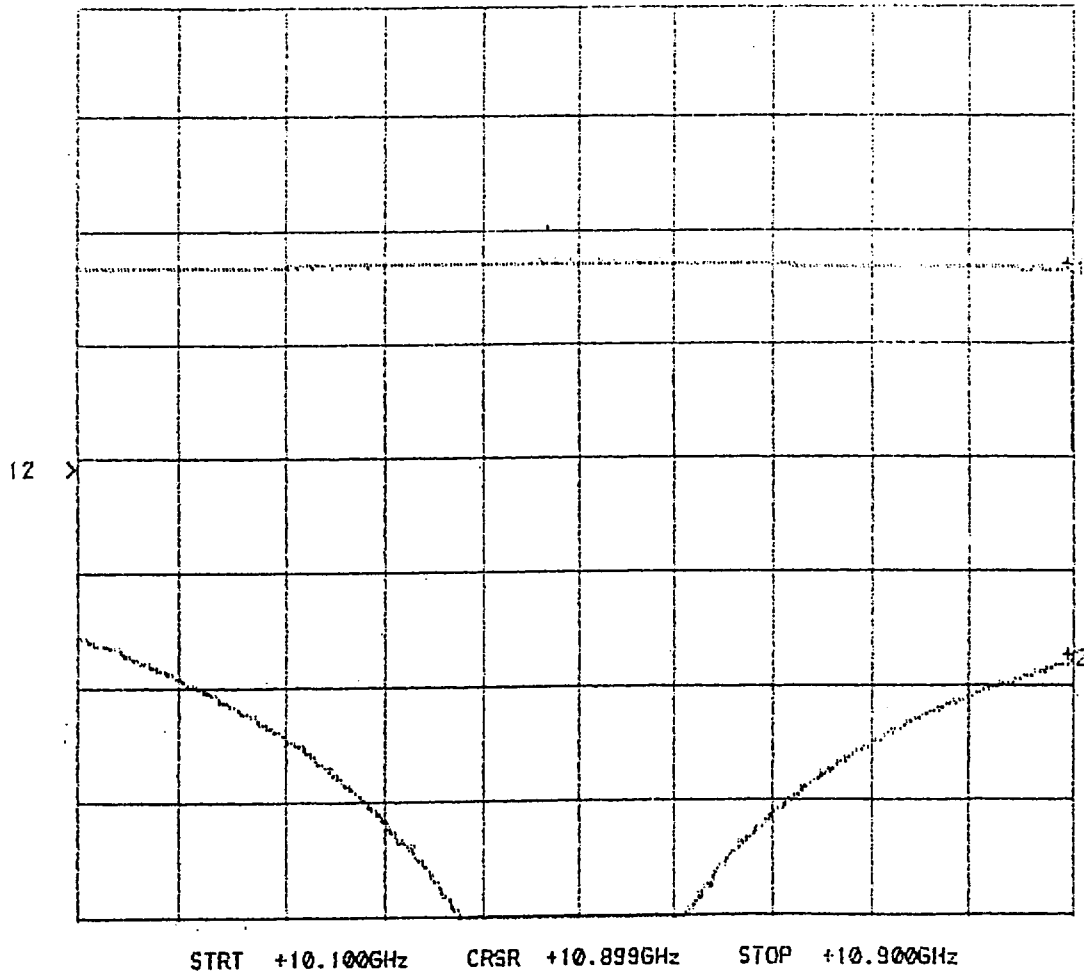

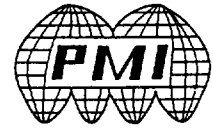

INSERTION LOSS AND RETURN LOSS

J1-J2 LOGIC "1"

SERIAL NUMBER: MC30986
AS MEASURED OVER 10.1 TO 10.9 GHz
READINGS TAKEN AT 10.9 GHz

| | | | | | |
|-------------|---|---------|-------------|---|----------|
| CH1: A -M | - | 2.11 dB | CH2: B -M | - | 14.62 dB |
| 1.0 dB/ REF | - | 2.50 dB | 5.0 dB/ REF | - | 9.54 dB |

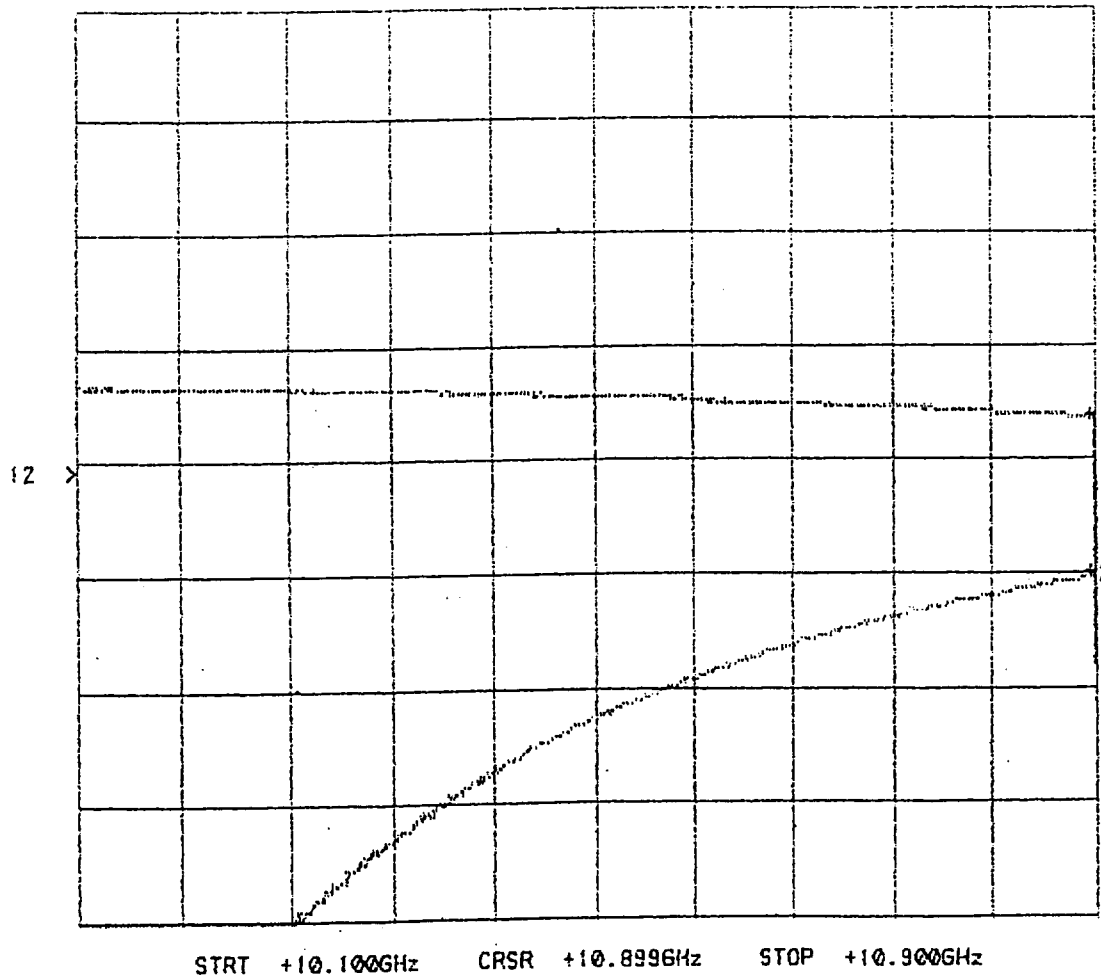

PLANAR MONOLITHICS INDUSTRIES, INC.

CORPORATE & ENGINEERING OFFICES: 1112 PERKIOMENVILLE ROAD, PERKIOMENVILLE, PA 18074
SALES & MANUFACTURING OFFICE: 7311-G GROVE ROAD, FREDERICK, MD 21704
TEL No: 301-662-4700 • FAX No: 301-662-4938 • E-MAIL: AMCPMI@AOL.COM



INSERTION LOSS AND RETURN LOSS

J2-J1 LOGIC "0"

SERIAL NUMBER: MC30986
AS MEASURED OVER 10.1 TO 10.9 GHz
READINGS TAKEN AT 10.9 GHz

| | | | | | |
|-------------|---|---------|-------------|---|----------|
| CH1: A -M | - | 1.78 dB | CH2: B -M | - | 19.26 dB |
| 1.0 dB/ REF | - | 2.50 dB | 5.0 dB/ REF | - | 9.54 dB |

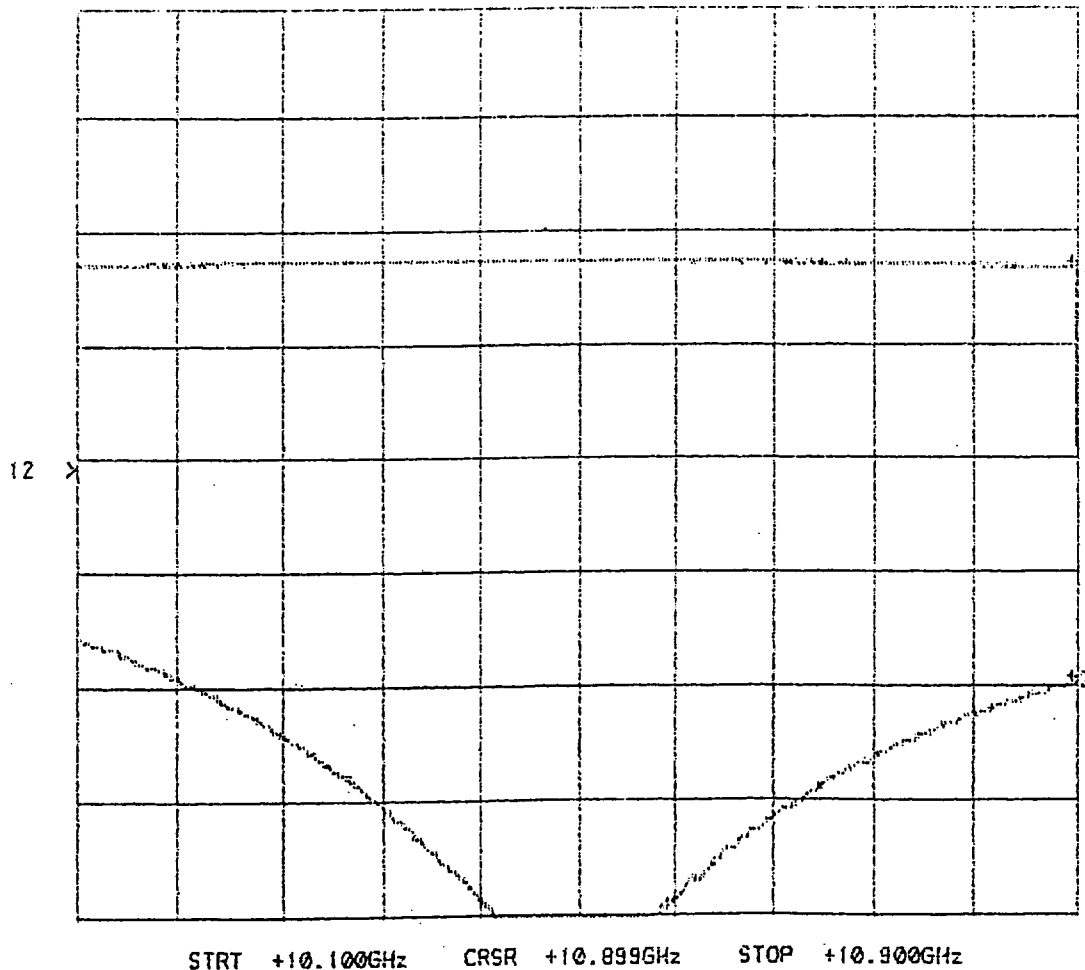

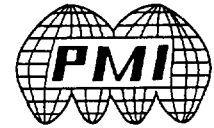

INSERTION LOSS AND RETURN LOSS

J2-J1 LOGIC "1"

SERIAL NUMBER: MC30986
AS MEASURED OVER 10.1 TO 10.9 GHz
READINGS TAKEN AT 10.9 GHz

CH1: A -M - 2.07 dB CH2: B -M - 14.23 dB
1.0 dB/ REF - 2.50 dB 5.0 dB/ REF - 9.54 dB

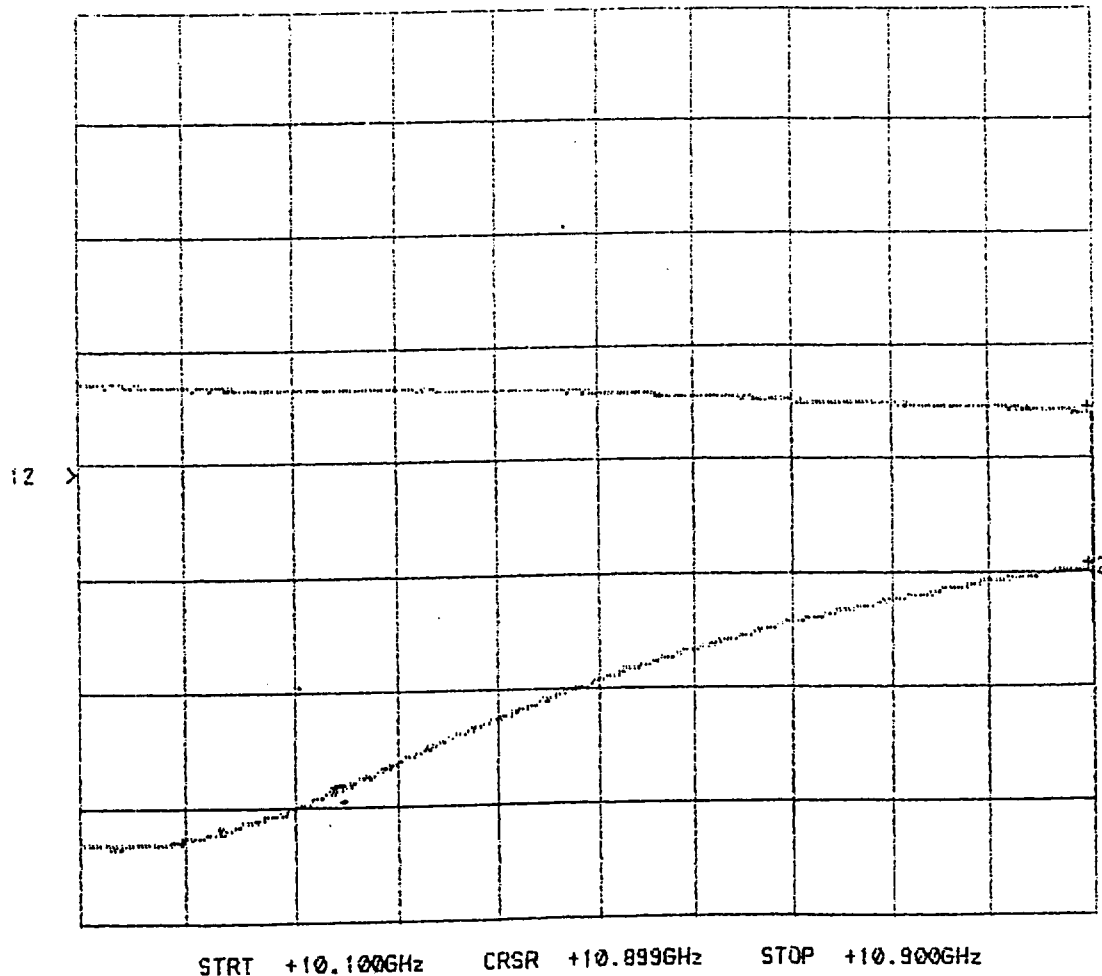

PLANAR MONOLITHICS INDUSTRIES, INC.

CORPORATE & ENGINEERING OFFICES: 1112 PERKIOMENVILLE ROAD, PERKIOMENVILLE, PA 18074
SALES & MANUFACTURING OFFICE: 7311-G GROVE ROAD, FREDERICK, MD 21704
TEL No: 301-662-4700 • FAX No: 301-662-4938 • E-MAIL: AMCPMI@AOL.COM

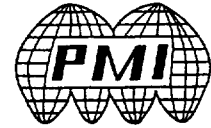

TYPICAL TEST DATA
 AS MEASURED FROM 10.2 TO 10.8 GHz

FORM: PS-1/0993



PHASE SHIFTER TEST DATA

JOBNO: 308194-2E MODELNO: PS-90 SERIALNO: MC30986
 CUSTOMER: Martin Marietta TECHNICIAN: RA
 SPECIFICATION: _____ FREQUENCY RANGE: 10.2 - 10.8 GHz

| INSERTION LOSS | VSWR | LOGIC |
|----------------|-----------|-------|
| J1-J2 0.82 dB | -18.37 dB | "1" |
| J1-J2 2.11 dB | -14.62 dB | "0" |
| | | |
| | | |
| | | |
| | | |
| | | |
| | | |
| | | |

NOTE: ANY ADDITIONAL TEST DATA WRITE ON BACK PAGE.

TESTED BY: *[Signature]*