

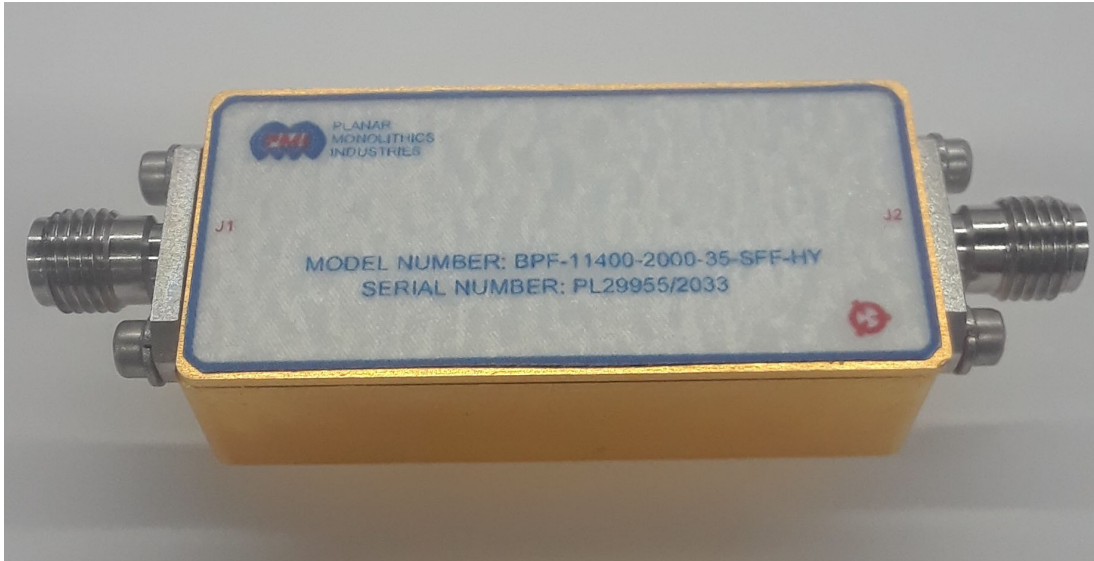

**Typical Characteristics
on
BPF-11400-2000-35-SFF-HY**

PLANAR MONOLITHICS INDUSTRIES MODEL NUMBER BPF-11400-2000-35-SFF-HY IS A BANDPASS FILTER. THE PASSBAND IS FROM 10400 TO 12400 MHz MINIMUM AND THE FILTER HAS THE FOLLOWING SPECIFICATIONS.



**Tested By: E. Kretz
August 10, 2020**

7311-F Grove Road Frederick, MD 21704 USA Phone: (301)662-5019 Fax: (301)662-1731
email: sales@pmi-rf.com



**Typical Characteristics
on
BPF-11400-2000-35-SFF-HY**

Table of Contents

OUTLINE DRAWING ----- Page 3

TEST DATA SUMMARY +23°C----- Page 4

TEST DATA SUMMARY -40°C----- Page 9

TEST DATA SUMMARY +85°C----- Page 14



Typical Characteristics on BPF-11400-2000-35-SFF-HY

OUTLINE DRAWING

ZONE	REV	DESCRIPTION	DATE	APPROVED
	A1	ORIGINAL RELEASE	09/08/00	

DESCRIPTION:
 PLANAR MONOLITHICS INDUSTRIES MODEL NUMBER BPF-11400-2000-35-SFF-HY IS A BANDPASS FILTER. THE PASSBAND IS FROM 10400 TO 12400 MHz MINIMUM AND THE FILTER HAS THE FOLLOWING SPECIFICATIONS.

SPECIFICATIONS:

- PASSBAND FREQUENCY RANGE:..... 10400 TO 12400 MHz MINIMUM
- -3 dB BANDWIDTH:..... 2000 MHz MINIMUM
- -1 dB PASSBAND INSERTION LOSS:..... 5 dB MAXIMUM
- PASSBAND VSWR:..... 2.0:1 MAXIMUM OVER 90% OF PASSBAND
- REJECTION:.....
 -35 dBc MINIMUM 100 - 10000 MHz
 -35 dBc MINIMUM 12900 - 18000 MHz

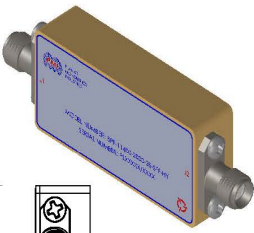
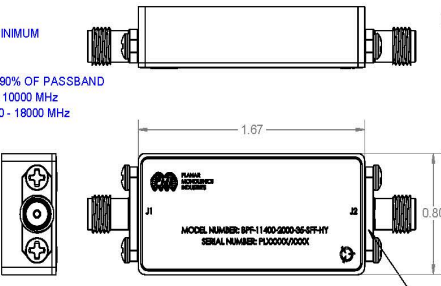
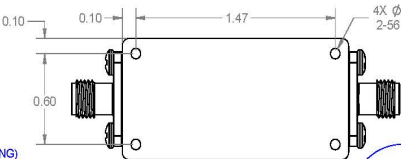
FIELD REPLACEABLE SMA (F) CONNECTORS 2 PLACES

• CONNECTORS:..... SMA FEMALE (FIELD REPLACEABLE)

• SIZE:..... 1.67" X 0.80" X 0.40"

• FINISH:..... GOLD PLATED

ENVIRONMENTAL RATINGS:

- TEMPERATURE:.....
 -45°C TO +85°C (OPERATING)
 -55°C TO +125°C (STORAGE)

NOTE: THE ABOVE SPECIFICATIONS ARE SUBJECT TO CHANGE OR REVISION. SPECIFICATIONS MAY VARY OVER TEMPERATURE.

PMI CONFIDENTIAL AND PROPRIETARY

PLANAR MONOLITHICS INDUSTRIES, INC.																											
<small>7311 GROVE ROAD FREDERICK, MARYLAND 21704 USA TEL: (301) 662-5019 FAX: (301) 662-1731 WWW.PMI-RF.COM</small>	<small>PMI PLANAR MONOLITHICS INDUSTRIES, INC.</small>																										
<table border="1" style="width: 100%; border-collapse: collapse;"> <tr> <th style="width: 50%;">APPROVALS</th> <th style="width: 50%;">DATE</th> </tr> <tr> <td style="text-align: center;">D. DURBIN</td> <td style="text-align: center;">04/03/00</td> </tr> </table>	APPROVALS	DATE	D. DURBIN	04/03/00	<table border="1" style="width: 100%; border-collapse: collapse;"> <tr> <td style="width: 50%;"> <table border="1" style="width: 100%; border-collapse: collapse;"> <tr> <th style="width: 50%;">REVISIONS</th> <th style="width: 50%;">DATE</th> </tr> <tr> <td style="text-align: center;">B</td> <td style="text-align: center;">09/08/00</td> </tr> </table> </td> <td style="width: 50%;"> <table border="1" style="width: 100%; border-collapse: collapse;"> <tr> <td style="width: 50%;"> <table border="1" style="width: 100%; border-collapse: collapse;"> <tr> <th style="width: 50%;">FILE</th> <th style="width: 50%;">TITLE</th> </tr> <tr> <td style="text-align: center;">BPF-11400-2000-35-SFF-HY</td> <td style="text-align: center;">OUTLINE DRAWING</td> </tr> </table> </td> <td style="width: 50%;"> <table border="1" style="width: 100%; border-collapse: collapse;"> <tr> <td style="width: 50%;"> <table border="1" style="width: 100%; border-collapse: collapse;"> <tr> <th style="width: 50%;">PART NO.</th> <th style="width: 50%;">DRAW NO.</th> </tr> <tr> <td style="text-align: center;">27038560</td> <td style="text-align: center;">A1</td> </tr> </table> </td> <td style="width: 50%;"> <table border="1" style="width: 100%; border-collapse: collapse;"> <tr> <th style="width: 50%;">SCALE</th> <th style="width: 50%;">SHEET</th> </tr> <tr> <td style="text-align: center;">2:1</td> <td style="text-align: center;">1 OF 1</td> </tr> </table> </td> </tr> </table> </td> </tr> </table> </td> </tr> </table>	<table border="1" style="width: 100%; border-collapse: collapse;"> <tr> <th style="width: 50%;">REVISIONS</th> <th style="width: 50%;">DATE</th> </tr> <tr> <td style="text-align: center;">B</td> <td style="text-align: center;">09/08/00</td> </tr> </table>	REVISIONS	DATE	B	09/08/00	<table border="1" style="width: 100%; border-collapse: collapse;"> <tr> <td style="width: 50%;"> <table border="1" style="width: 100%; border-collapse: collapse;"> <tr> <th style="width: 50%;">FILE</th> <th style="width: 50%;">TITLE</th> </tr> <tr> <td style="text-align: center;">BPF-11400-2000-35-SFF-HY</td> <td style="text-align: center;">OUTLINE DRAWING</td> </tr> </table> </td> <td style="width: 50%;"> <table border="1" style="width: 100%; border-collapse: collapse;"> <tr> <td style="width: 50%;"> <table border="1" style="width: 100%; border-collapse: collapse;"> <tr> <th style="width: 50%;">PART NO.</th> <th style="width: 50%;">DRAW NO.</th> </tr> <tr> <td style="text-align: center;">27038560</td> <td style="text-align: center;">A1</td> </tr> </table> </td> <td style="width: 50%;"> <table border="1" style="width: 100%; border-collapse: collapse;"> <tr> <th style="width: 50%;">SCALE</th> <th style="width: 50%;">SHEET</th> </tr> <tr> <td style="text-align: center;">2:1</td> <td style="text-align: center;">1 OF 1</td> </tr> </table> </td> </tr> </table> </td> </tr> </table>	<table border="1" style="width: 100%; border-collapse: collapse;"> <tr> <th style="width: 50%;">FILE</th> <th style="width: 50%;">TITLE</th> </tr> <tr> <td style="text-align: center;">BPF-11400-2000-35-SFF-HY</td> <td style="text-align: center;">OUTLINE DRAWING</td> </tr> </table>	FILE	TITLE	BPF-11400-2000-35-SFF-HY	OUTLINE DRAWING	<table border="1" style="width: 100%; border-collapse: collapse;"> <tr> <td style="width: 50%;"> <table border="1" style="width: 100%; border-collapse: collapse;"> <tr> <th style="width: 50%;">PART NO.</th> <th style="width: 50%;">DRAW NO.</th> </tr> <tr> <td style="text-align: center;">27038560</td> <td style="text-align: center;">A1</td> </tr> </table> </td> <td style="width: 50%;"> <table border="1" style="width: 100%; border-collapse: collapse;"> <tr> <th style="width: 50%;">SCALE</th> <th style="width: 50%;">SHEET</th> </tr> <tr> <td style="text-align: center;">2:1</td> <td style="text-align: center;">1 OF 1</td> </tr> </table> </td> </tr> </table>	<table border="1" style="width: 100%; border-collapse: collapse;"> <tr> <th style="width: 50%;">PART NO.</th> <th style="width: 50%;">DRAW NO.</th> </tr> <tr> <td style="text-align: center;">27038560</td> <td style="text-align: center;">A1</td> </tr> </table>	PART NO.	DRAW NO.	27038560	A1	<table border="1" style="width: 100%; border-collapse: collapse;"> <tr> <th style="width: 50%;">SCALE</th> <th style="width: 50%;">SHEET</th> </tr> <tr> <td style="text-align: center;">2:1</td> <td style="text-align: center;">1 OF 1</td> </tr> </table>	SCALE	SHEET	2:1	1 OF 1
APPROVALS	DATE																										
D. DURBIN	04/03/00																										
<table border="1" style="width: 100%; border-collapse: collapse;"> <tr> <th style="width: 50%;">REVISIONS</th> <th style="width: 50%;">DATE</th> </tr> <tr> <td style="text-align: center;">B</td> <td style="text-align: center;">09/08/00</td> </tr> </table>	REVISIONS	DATE	B	09/08/00	<table border="1" style="width: 100%; border-collapse: collapse;"> <tr> <td style="width: 50%;"> <table border="1" style="width: 100%; border-collapse: collapse;"> <tr> <th style="width: 50%;">FILE</th> <th style="width: 50%;">TITLE</th> </tr> <tr> <td style="text-align: center;">BPF-11400-2000-35-SFF-HY</td> <td style="text-align: center;">OUTLINE DRAWING</td> </tr> </table> </td> <td style="width: 50%;"> <table border="1" style="width: 100%; border-collapse: collapse;"> <tr> <td style="width: 50%;"> <table border="1" style="width: 100%; border-collapse: collapse;"> <tr> <th style="width: 50%;">PART NO.</th> <th style="width: 50%;">DRAW NO.</th> </tr> <tr> <td style="text-align: center;">27038560</td> <td style="text-align: center;">A1</td> </tr> </table> </td> <td style="width: 50%;"> <table border="1" style="width: 100%; border-collapse: collapse;"> <tr> <th style="width: 50%;">SCALE</th> <th style="width: 50%;">SHEET</th> </tr> <tr> <td style="text-align: center;">2:1</td> <td style="text-align: center;">1 OF 1</td> </tr> </table> </td> </tr> </table> </td> </tr> </table>	<table border="1" style="width: 100%; border-collapse: collapse;"> <tr> <th style="width: 50%;">FILE</th> <th style="width: 50%;">TITLE</th> </tr> <tr> <td style="text-align: center;">BPF-11400-2000-35-SFF-HY</td> <td style="text-align: center;">OUTLINE DRAWING</td> </tr> </table>	FILE	TITLE	BPF-11400-2000-35-SFF-HY	OUTLINE DRAWING	<table border="1" style="width: 100%; border-collapse: collapse;"> <tr> <td style="width: 50%;"> <table border="1" style="width: 100%; border-collapse: collapse;"> <tr> <th style="width: 50%;">PART NO.</th> <th style="width: 50%;">DRAW NO.</th> </tr> <tr> <td style="text-align: center;">27038560</td> <td style="text-align: center;">A1</td> </tr> </table> </td> <td style="width: 50%;"> <table border="1" style="width: 100%; border-collapse: collapse;"> <tr> <th style="width: 50%;">SCALE</th> <th style="width: 50%;">SHEET</th> </tr> <tr> <td style="text-align: center;">2:1</td> <td style="text-align: center;">1 OF 1</td> </tr> </table> </td> </tr> </table>	<table border="1" style="width: 100%; border-collapse: collapse;"> <tr> <th style="width: 50%;">PART NO.</th> <th style="width: 50%;">DRAW NO.</th> </tr> <tr> <td style="text-align: center;">27038560</td> <td style="text-align: center;">A1</td> </tr> </table>	PART NO.	DRAW NO.	27038560	A1	<table border="1" style="width: 100%; border-collapse: collapse;"> <tr> <th style="width: 50%;">SCALE</th> <th style="width: 50%;">SHEET</th> </tr> <tr> <td style="text-align: center;">2:1</td> <td style="text-align: center;">1 OF 1</td> </tr> </table>	SCALE	SHEET	2:1	1 OF 1						
REVISIONS	DATE																										
B	09/08/00																										
<table border="1" style="width: 100%; border-collapse: collapse;"> <tr> <th style="width: 50%;">FILE</th> <th style="width: 50%;">TITLE</th> </tr> <tr> <td style="text-align: center;">BPF-11400-2000-35-SFF-HY</td> <td style="text-align: center;">OUTLINE DRAWING</td> </tr> </table>	FILE	TITLE	BPF-11400-2000-35-SFF-HY	OUTLINE DRAWING	<table border="1" style="width: 100%; border-collapse: collapse;"> <tr> <td style="width: 50%;"> <table border="1" style="width: 100%; border-collapse: collapse;"> <tr> <th style="width: 50%;">PART NO.</th> <th style="width: 50%;">DRAW NO.</th> </tr> <tr> <td style="text-align: center;">27038560</td> <td style="text-align: center;">A1</td> </tr> </table> </td> <td style="width: 50%;"> <table border="1" style="width: 100%; border-collapse: collapse;"> <tr> <th style="width: 50%;">SCALE</th> <th style="width: 50%;">SHEET</th> </tr> <tr> <td style="text-align: center;">2:1</td> <td style="text-align: center;">1 OF 1</td> </tr> </table> </td> </tr> </table>	<table border="1" style="width: 100%; border-collapse: collapse;"> <tr> <th style="width: 50%;">PART NO.</th> <th style="width: 50%;">DRAW NO.</th> </tr> <tr> <td style="text-align: center;">27038560</td> <td style="text-align: center;">A1</td> </tr> </table>	PART NO.	DRAW NO.	27038560	A1	<table border="1" style="width: 100%; border-collapse: collapse;"> <tr> <th style="width: 50%;">SCALE</th> <th style="width: 50%;">SHEET</th> </tr> <tr> <td style="text-align: center;">2:1</td> <td style="text-align: center;">1 OF 1</td> </tr> </table>	SCALE	SHEET	2:1	1 OF 1												
FILE	TITLE																										
BPF-11400-2000-35-SFF-HY	OUTLINE DRAWING																										
<table border="1" style="width: 100%; border-collapse: collapse;"> <tr> <th style="width: 50%;">PART NO.</th> <th style="width: 50%;">DRAW NO.</th> </tr> <tr> <td style="text-align: center;">27038560</td> <td style="text-align: center;">A1</td> </tr> </table>	PART NO.	DRAW NO.	27038560	A1	<table border="1" style="width: 100%; border-collapse: collapse;"> <tr> <th style="width: 50%;">SCALE</th> <th style="width: 50%;">SHEET</th> </tr> <tr> <td style="text-align: center;">2:1</td> <td style="text-align: center;">1 OF 1</td> </tr> </table>	SCALE	SHEET	2:1	1 OF 1																		
PART NO.	DRAW NO.																										
27038560	A1																										
SCALE	SHEET																										
2:1	1 OF 1																										

7311-F Grove Road Frederick, MD 21704 USA Phone: (301)662-5019 Fax: (301)662-1731
 email: sales@pmi-rf.com



**Typical Characteristics
on
BPF-11400-2000-35-SFF-HY**

TEST DATA SUMMARY +23°C

TEST ITEM NO.	PARAMETERS	SPECIFIED VALUE	Test Results	QA QC
1	Passband	10.4 To 12.4 GHz	10.4 To 12.4 GHz	
2	Passband Flatness	3 dB MAX	1.84 dB	
3	Rejection	-35 dBc MIN 0.1 - 10.0 GHz -35 dBc MIN 12.8 - 18.0 GHz	-54.24 @ 0.1 - 10.0 GHz -49.52 @ 12.8 - 18.0 GHz	
4	Passband VSWR:	2.0:1 MAX	1.67:1	
5	Insertion Loss (1 dB PASSBAND):	5.0 dB MAX	2.93 dB	



Typical Characteristics on BPF-11400-2000-35-SFF-HY

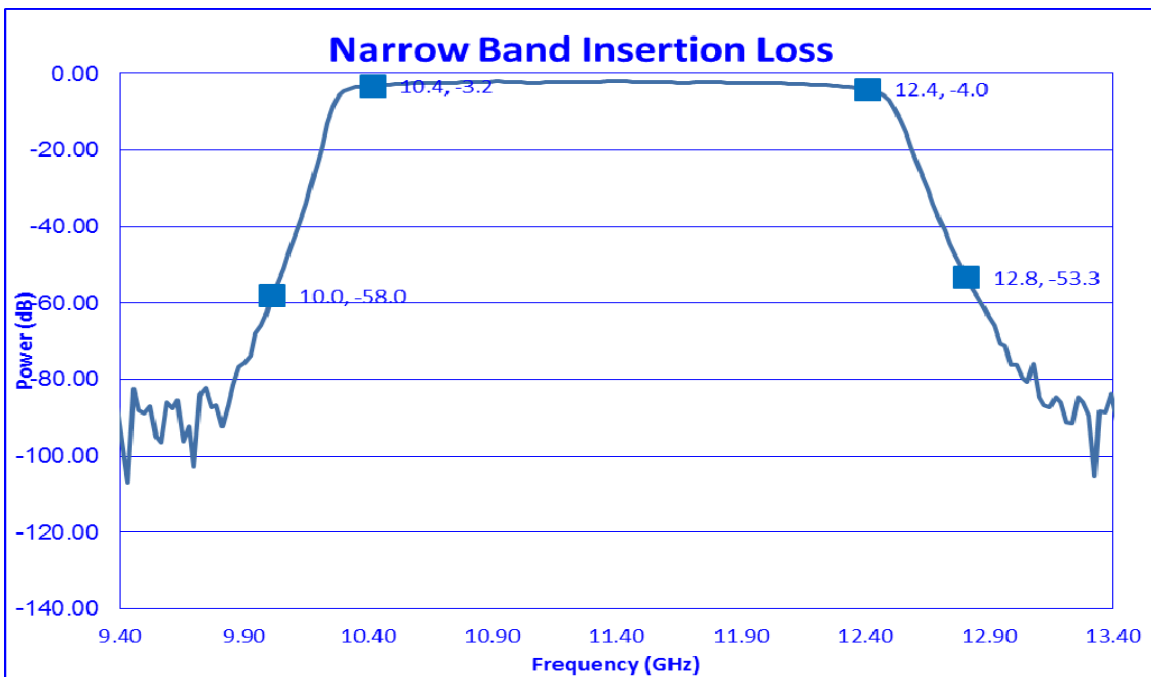
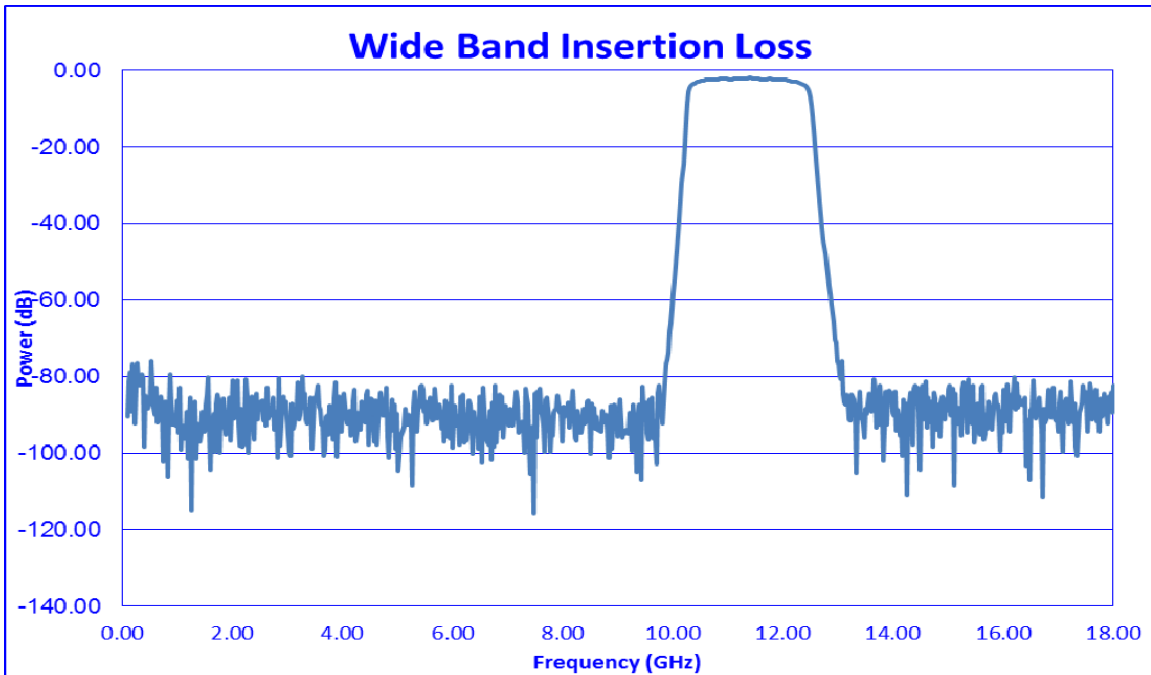



Typical Characteristics on BPF-11400-2000-35-SFF-HY

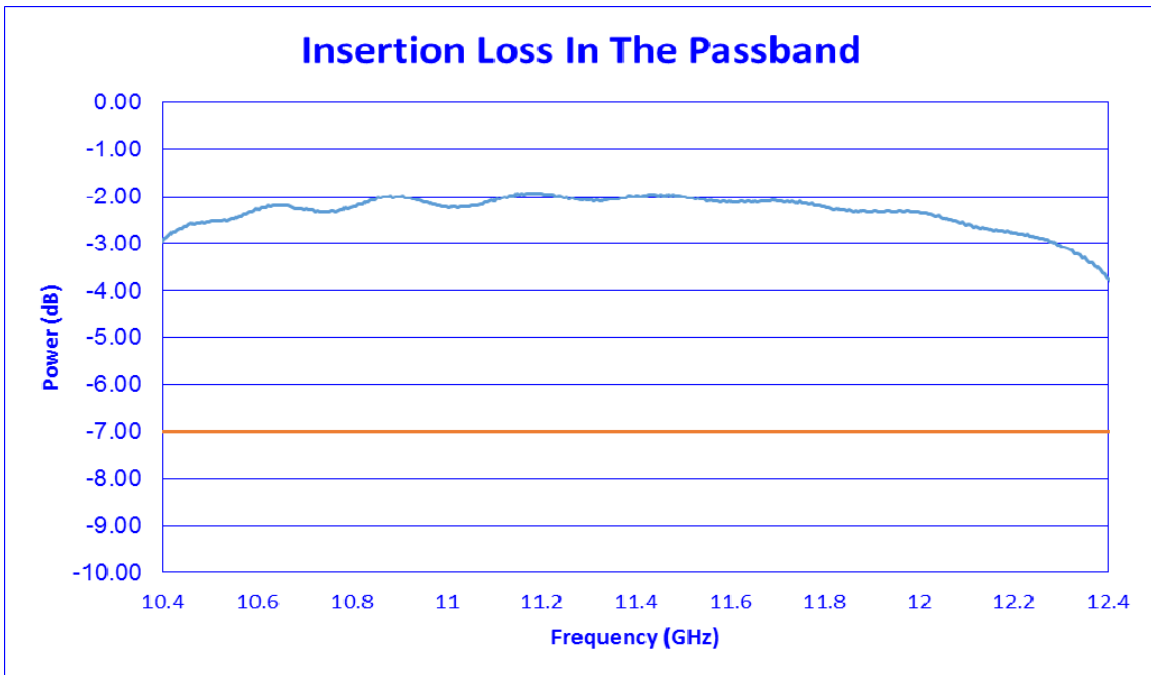
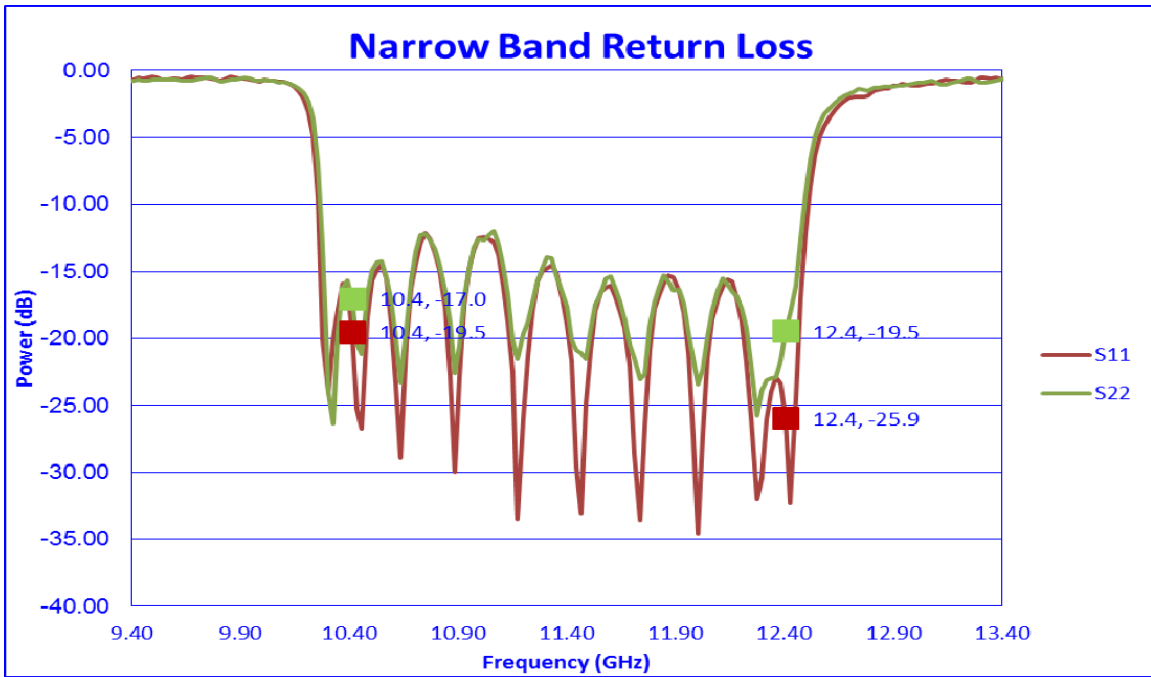



Typical Characteristics on BPF-11400-2000-35-SFF-HY

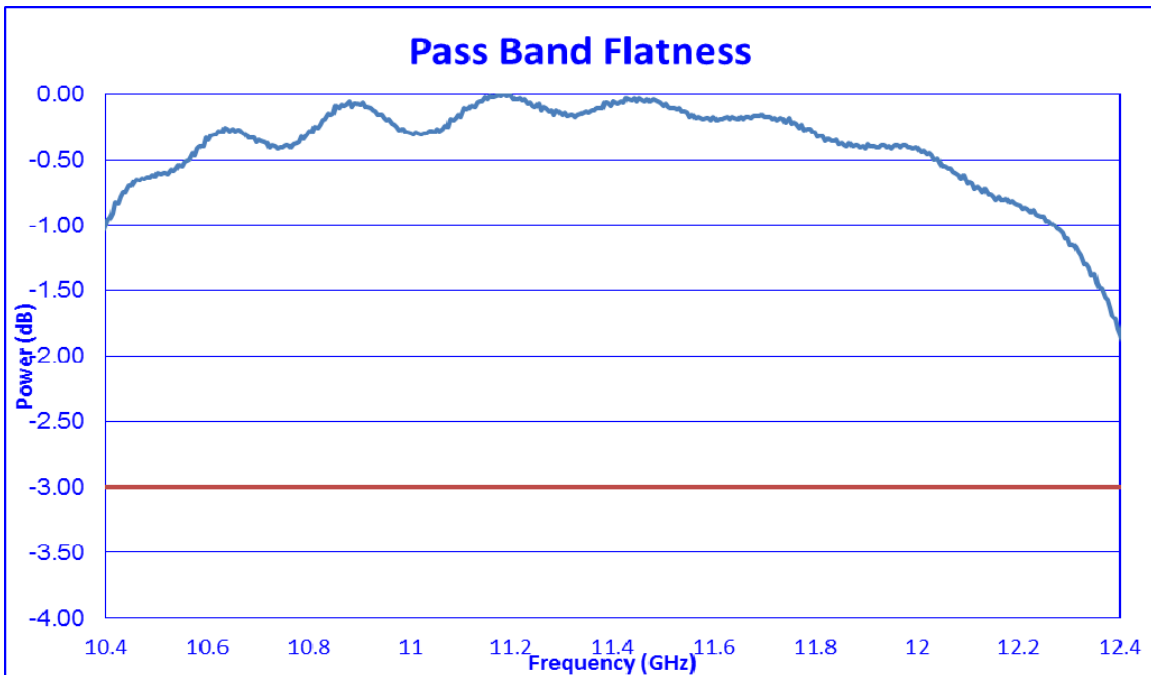
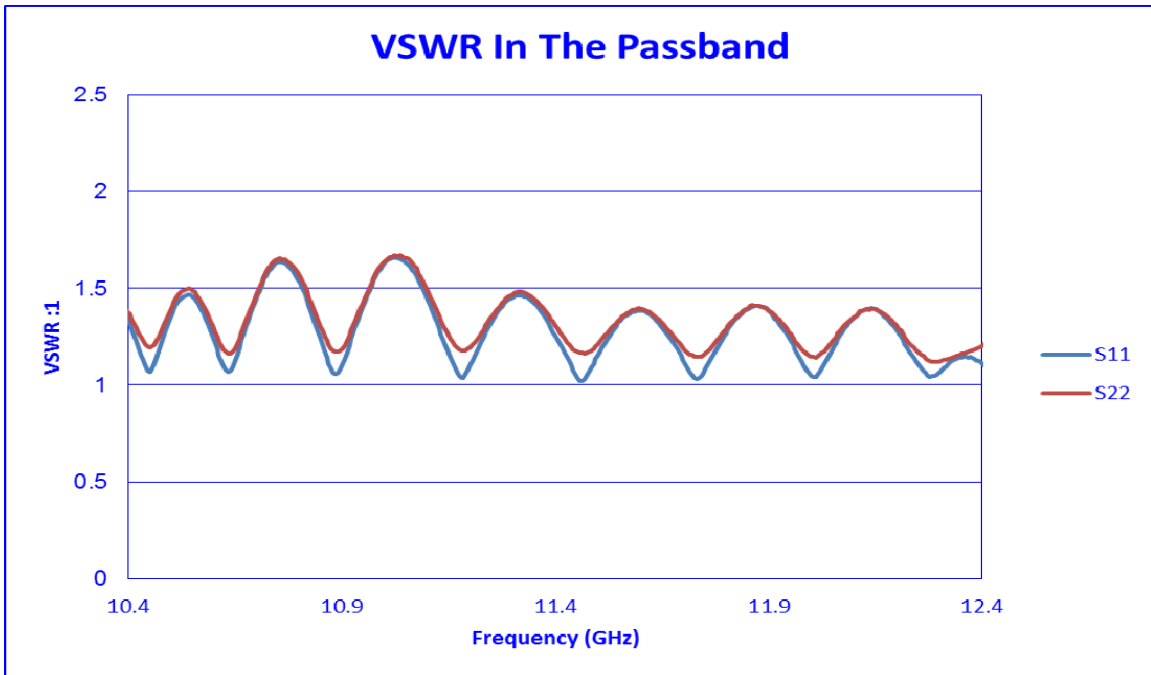



**Typical Characteristics
on
BPF-11400-2000-35-SFF-HY**

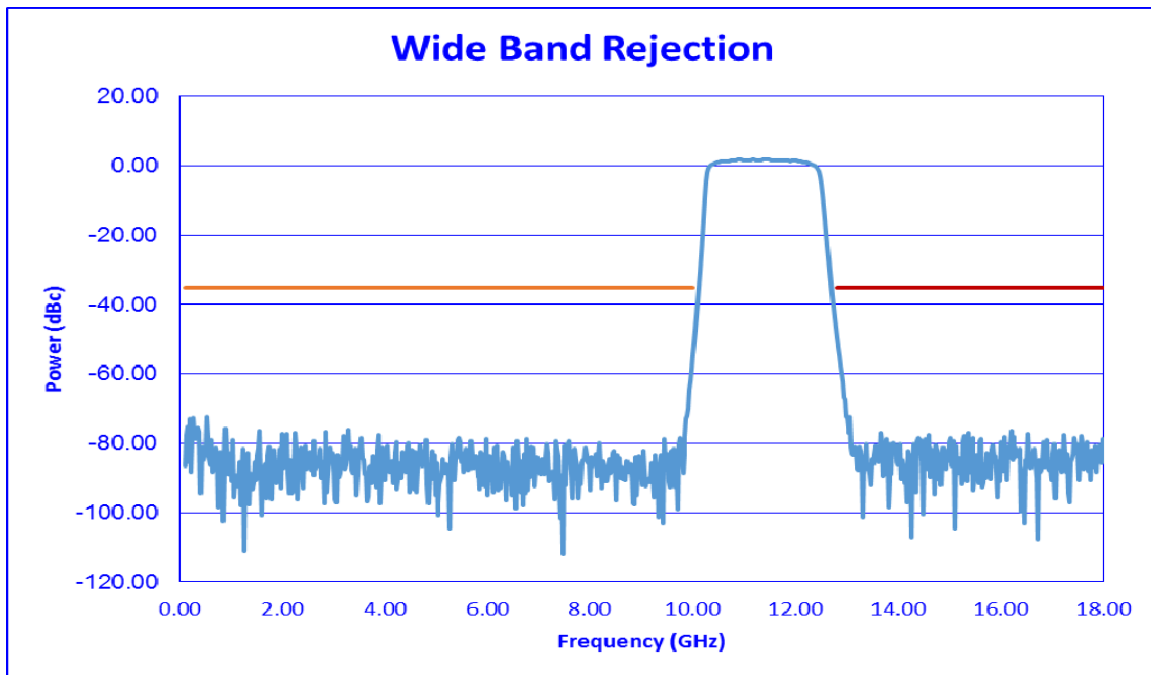



Typical Characteristics
on
BPF-11400-2000-35-SFF-HY

TEST DATA SUMMARY -40°C

TEST ITEM NO.	PARAMETERS	SPECIFIED VALUE	Test Results	QA QC
1	Passband	10.4 To 12.4 GHz	10.4 To 12.4 GHz	
2	Passband Flatness	3 dB MAX	1.32 dB	
3	Rejection	-35 dBc MIN 0.1 - 10.0 GHz -35 dBc MIN 12.8 - 18.0 GHz	-60.46 @ 0.1 - 10.0 GHz -44.12 @ 12.8 - 18.0 GHz	
4	Passband VSWR:	2.0:1 MAX	1.68:1	
5	Insertion Loss (1 dB PASSBAND):	5.0 dB MAX	2.74 dB	



Typical Characteristics on BPF-11400-2000-35-SFF-HY

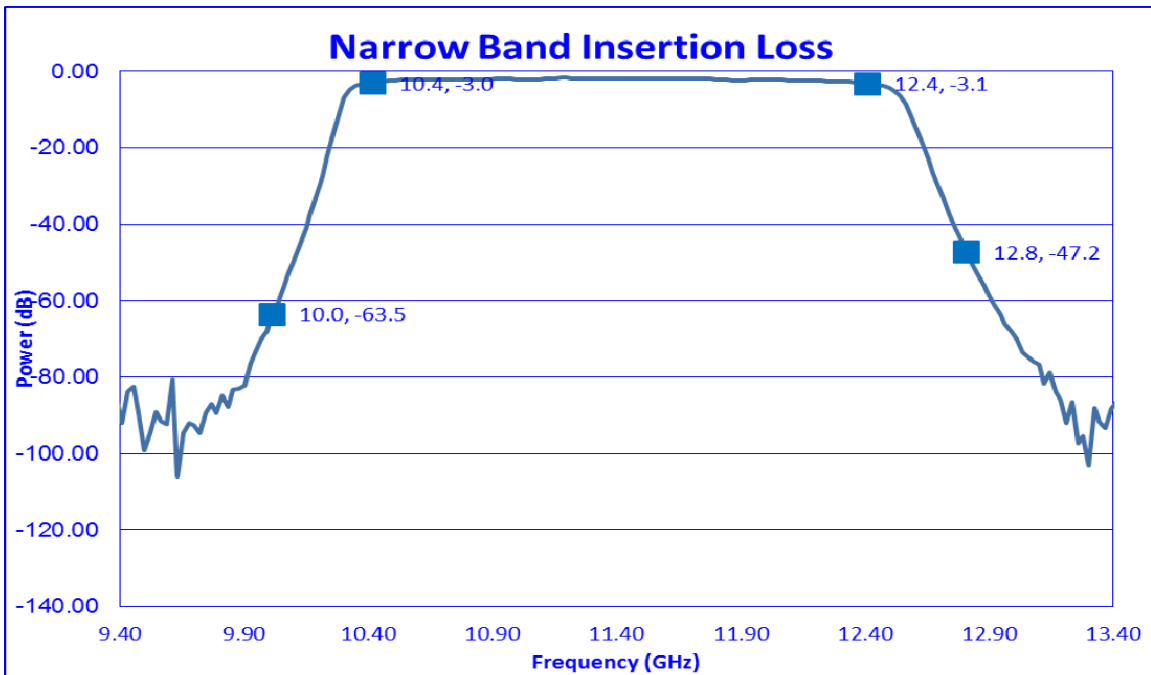
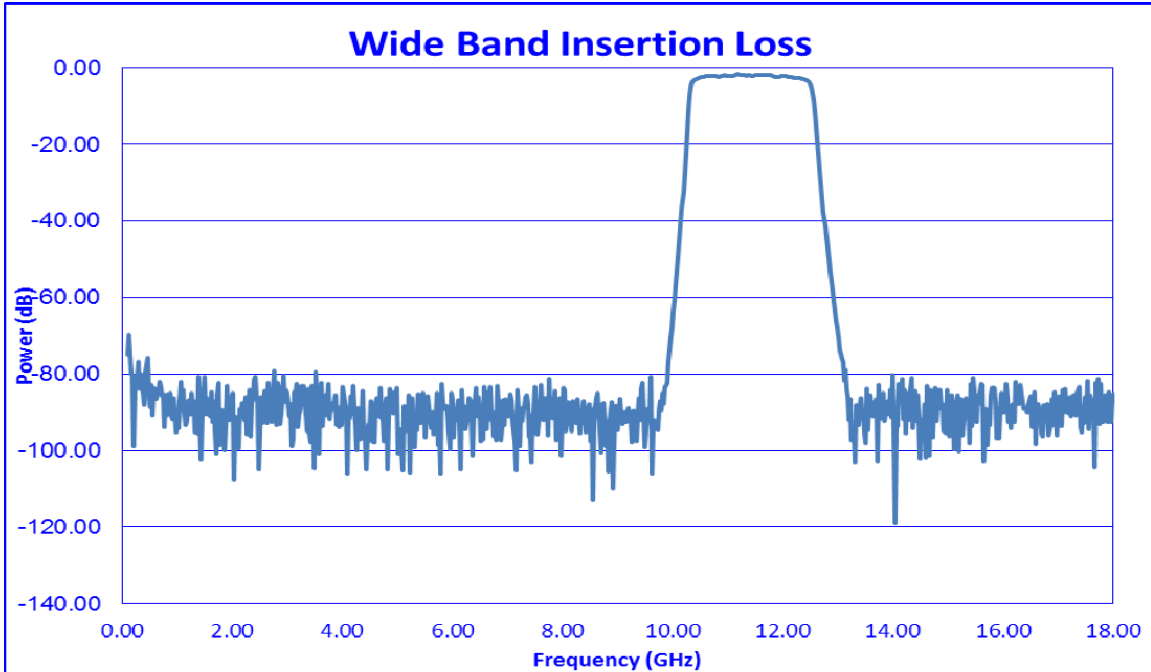

7311-F Grove Road Frederick, MD 21704 USA Phone: (301)662-5019 Fax: (301)662-1731
email: sales@pmi-rf.com



Typical Characteristics on BPF-11400-2000-35-SFF-HY

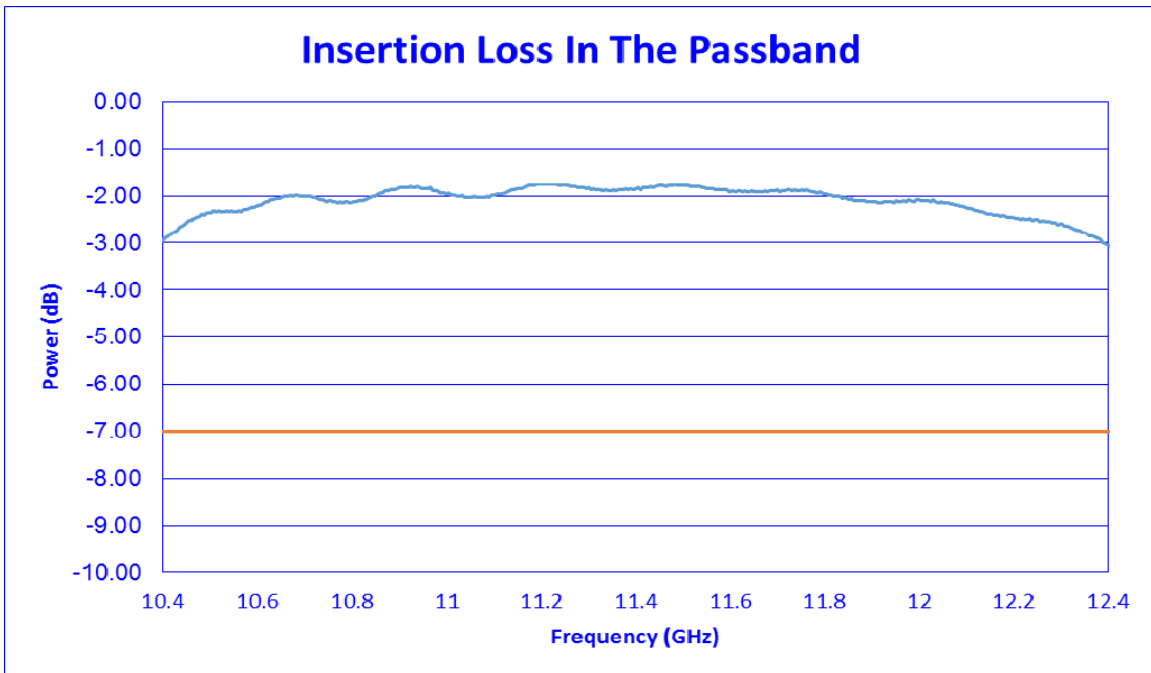
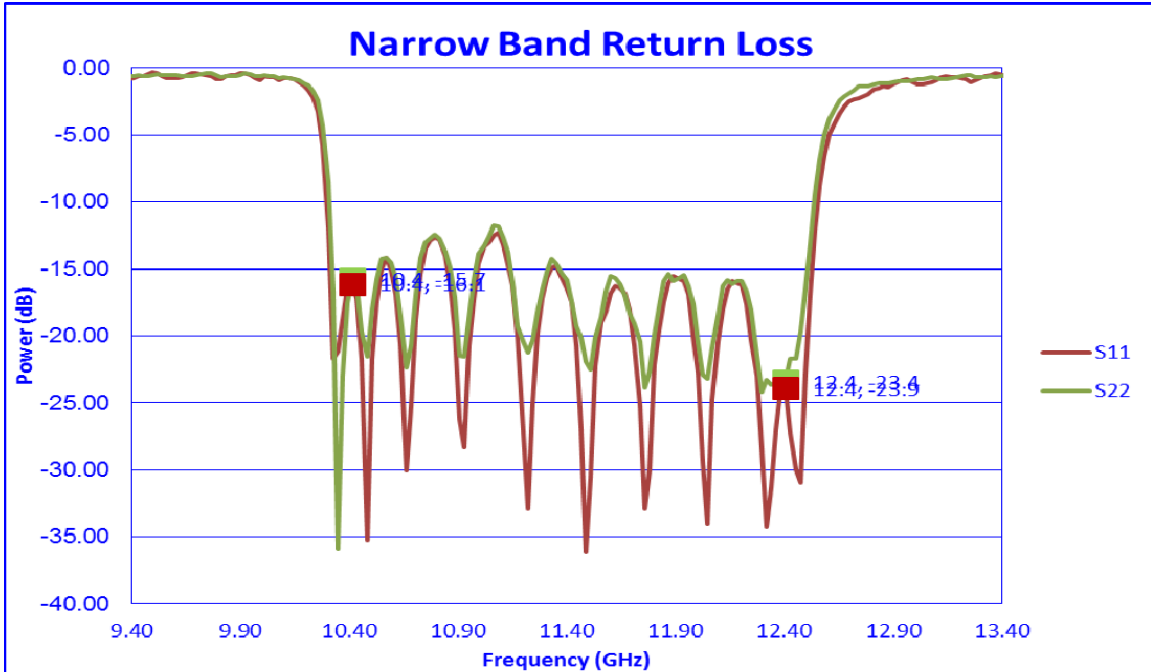



Typical Characteristics on BPF-11400-2000-35-SFF-HY

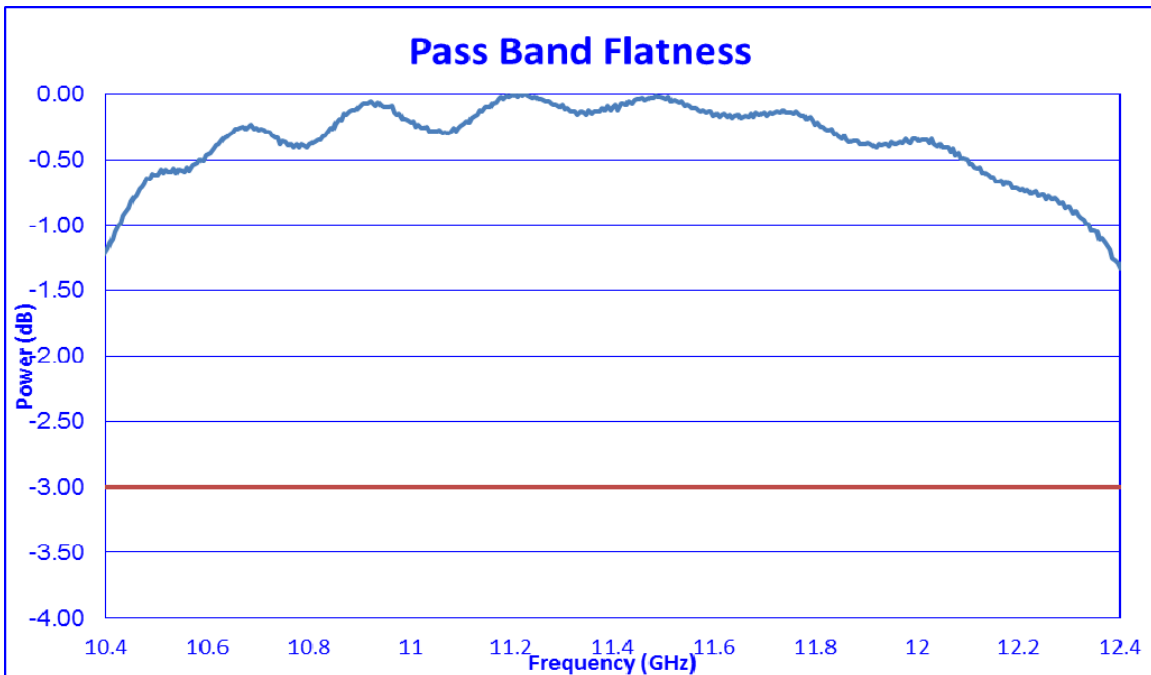
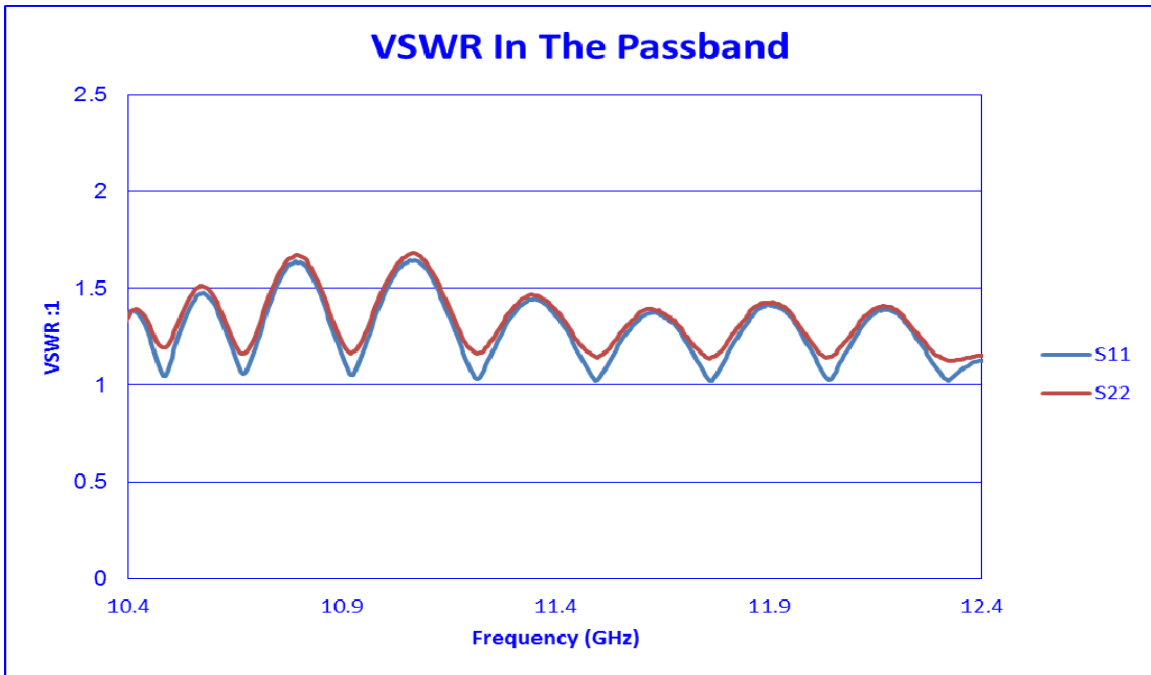



**Typical Characteristics
on
BPF-11400-2000-35-SFF-HY**

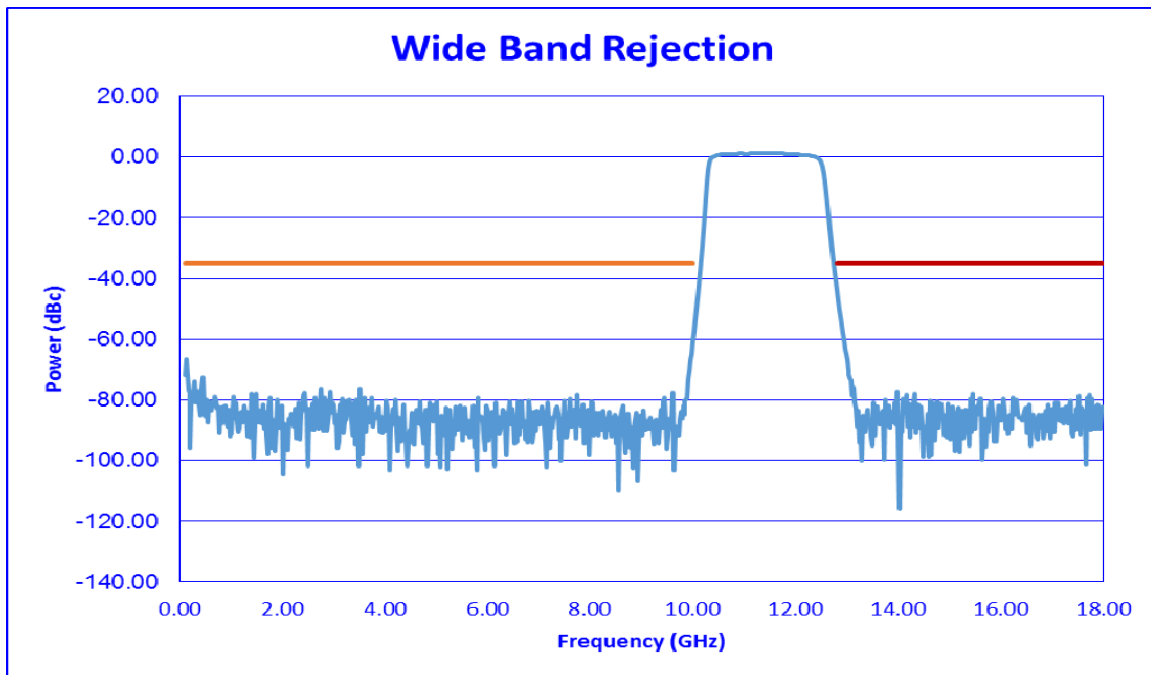



Typical Characteristics
on
BPF-11400-2000-35-SFF-HY

TEST DATA SUMMARY +85°C

TEST ITEM NO.	PARAMETERS	SPECIFIED VALUE	Test Results	QA QC
1	Passband	10.4 To 12.4 GHz	10.4 To 12.4 GHz	
2	Passband Flatness	3 dB MAX	2.72 dB	
3	Rejection	-35 dBc MIN 0.1 - 10.0 GHz -35 dBc MIN 12.8 - 18.0 GHz	-49.01 @ 0.1 - 10.0 GHz -54.98 @ 12.8 - 18.0 GHz	
4	Passband VSWR:	2.0:1 MAX	1.71:1	
5	Insertion Loss (1 dB PASSBAND):	5.0 dB MAX	3.3 dB	



Typical Characteristics on BPF-11400-2000-35-SFF-HY

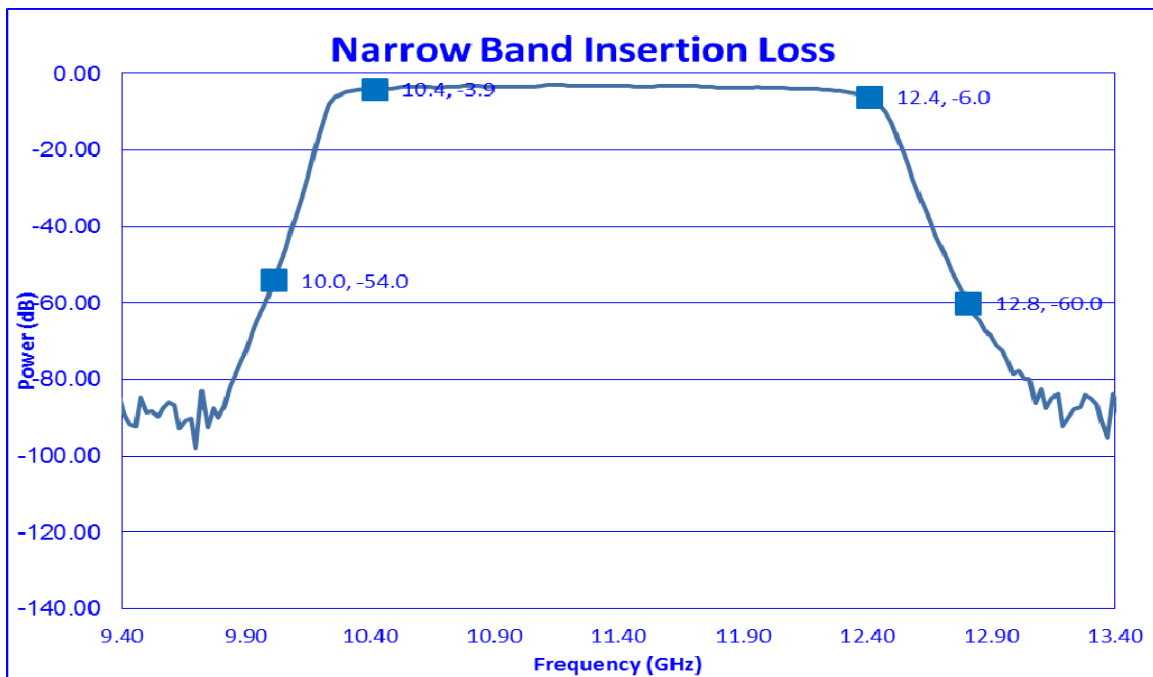
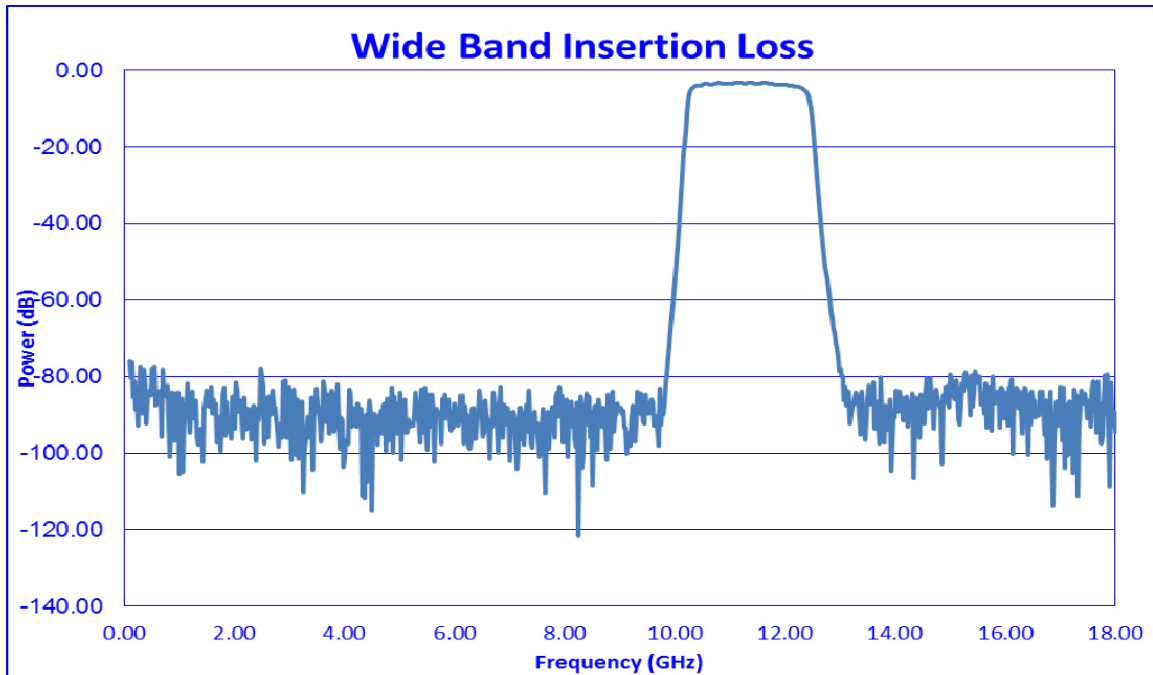



Typical Characteristics on BPF-11400-2000-35-SFF-HY

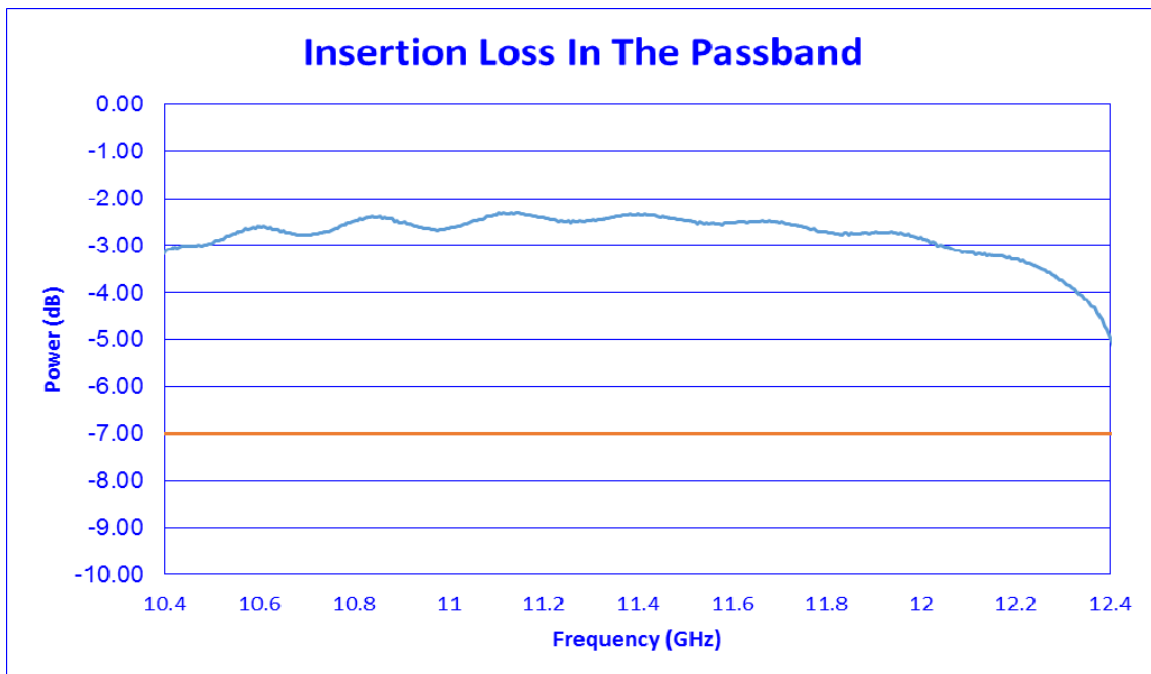
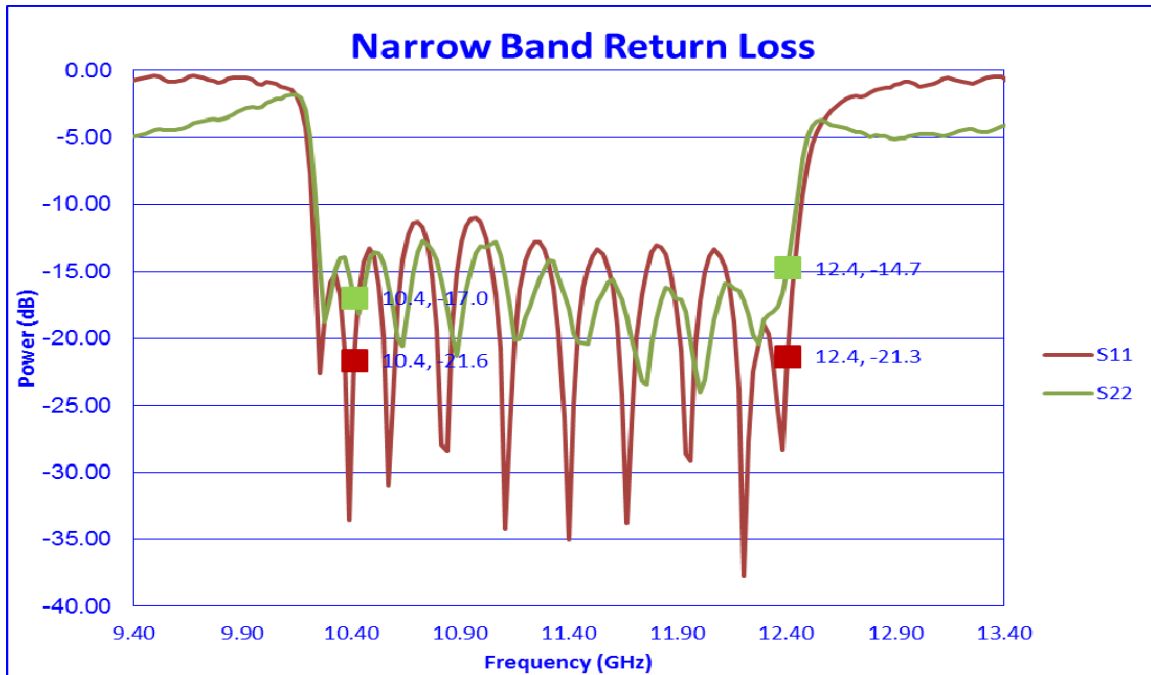



Typical Characteristics on BPF-11400-2000-35-SFF-HY

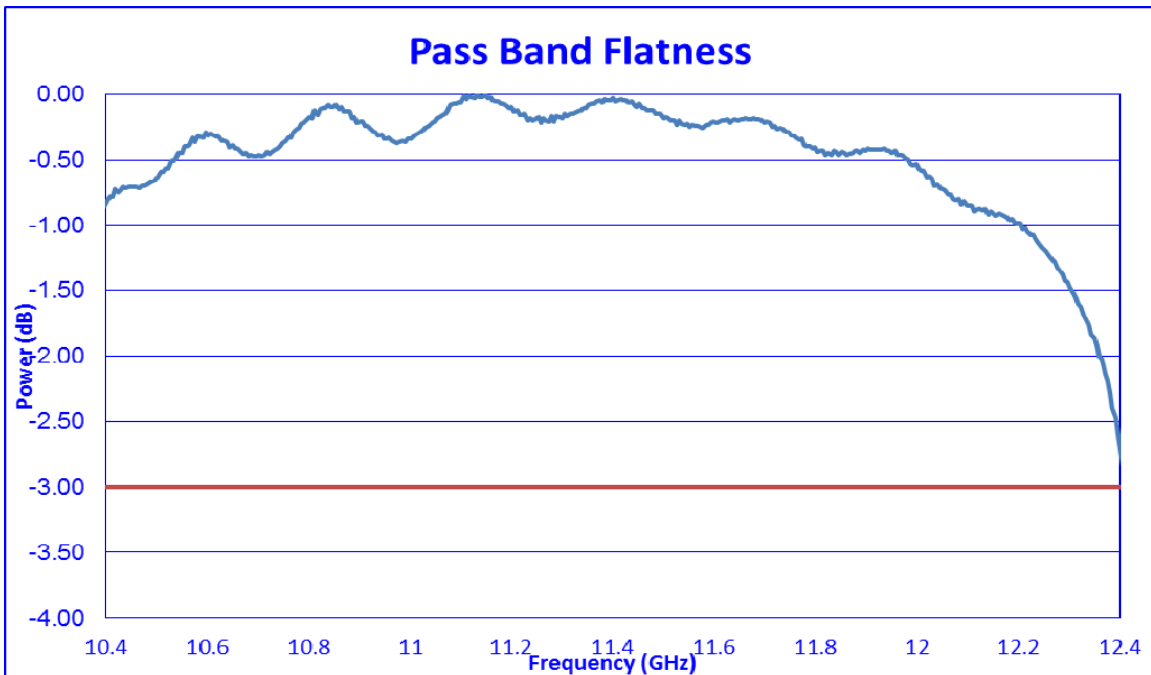
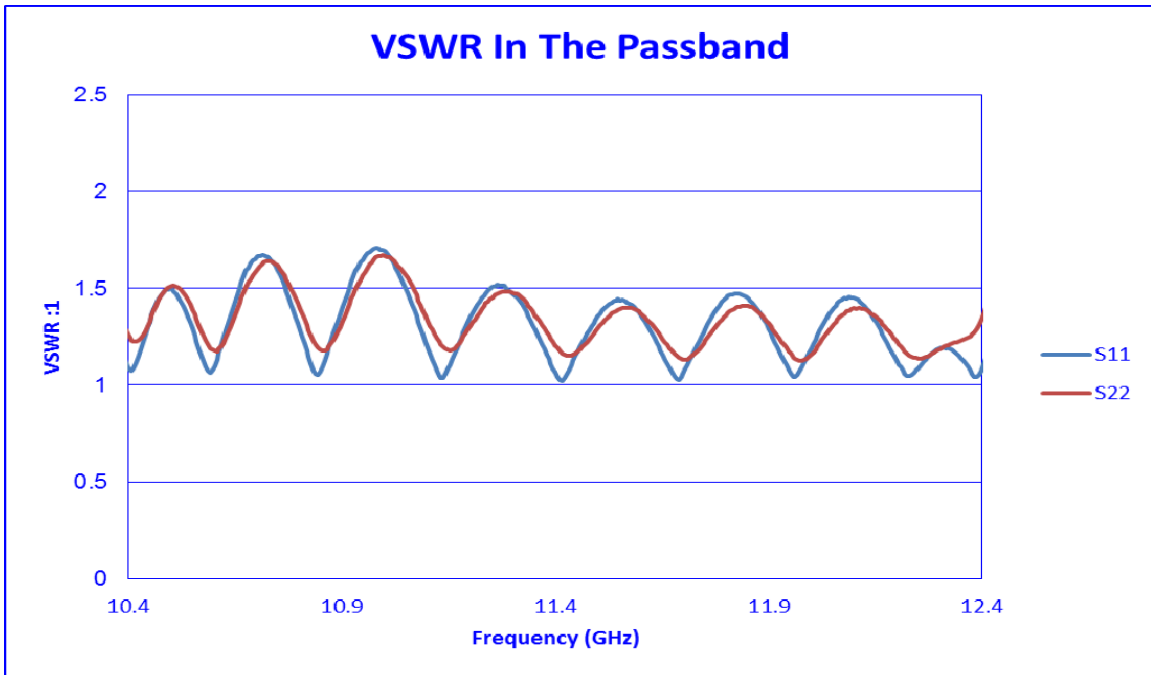



**Typical Characteristics
on
BPF-11400-2000-35-SFF-HY**

